

Panasonic

INDUSTRY

Contact-Type **Self-Monitoring Sensor**
Digital Displacement Sensor

HG-S SERIES



Robust and slim body contributes to a longer service life

The optical absolute method eliminates “value skipping” and “unset zero point”!

Introducing New Sensor Heads and New Communication Units!

Sensor head
Air-driven type
10 mm **0.394 in** type



Sensor head

Regular type
General purpose type
50 mm **1.969 in** type



Communication unit for digital displacement sensors

EtherCAT communication unit



EtherCAT



Equipped with Self-monitoring Function

Contact-type digital displacement sensor using optical absolute method developed to meet

New contact-type digital displacement sensor developed to meet the needs of production floor.
The high-precision slim sensor unit features a robust sensor head, while the controller offers a diversity of functions.

› Sensor head

Development target: **Slim & Robust**

- The 10 mm **0.394 in** type has a slim 11 × 18 × 84.5 mm **0.433 × 0.709 × 3.327 in** body, for easy adjacent installation
- Class-top robustness in the industry

Lateral load resistance
No. 1* in class

Vibration / impact resistance
No. 1* in class

* As of January 2021, in-company survey.

Development goal: **Highest Accuracy in Class**

- Resolution of 0.1 μm **0.004 mil*** and indication accuracy of 1.0 μm **0.039 mil** or less*
- Absolute value scale reading for elimination of “value skipping” and “unset zero point”

Resolution
No. 1* in class

Indication accuracy
No. 1* in class

Optical absolute method

* In the case of high-precision sensor heads (HG-S1110□). As of January 2021, in-company survey.

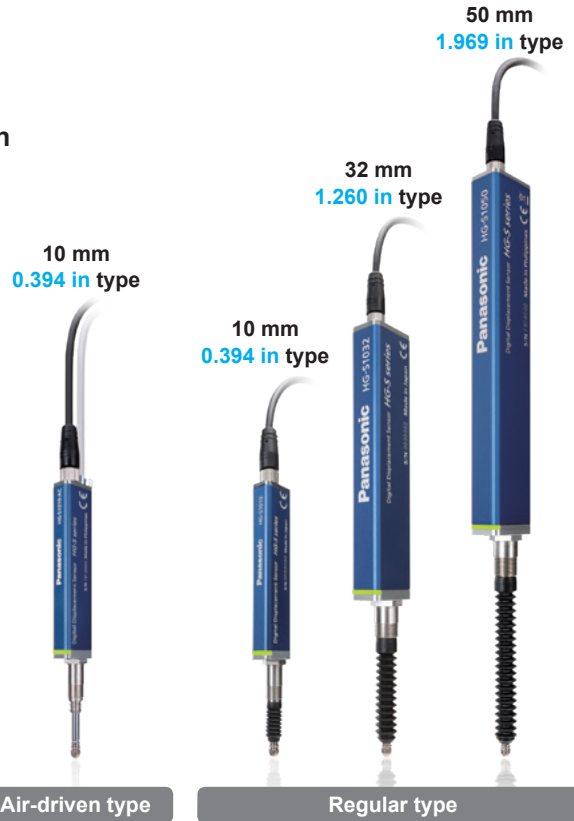

Applications

For electric and electronic parts



Motor shaft eccentricity measurement

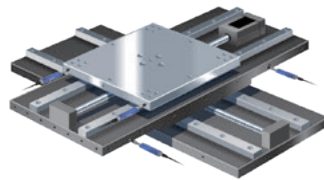

X-Y stage position measurement

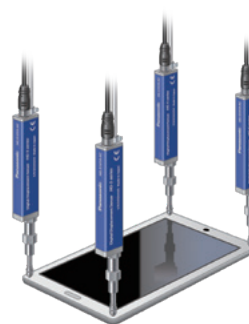

Smartphone flatness measurement



Parts installation inspection



Resin roller eccentricity measurement

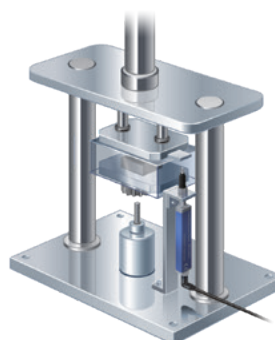

Contact-type displacement sensor and load cell are used to manage pressure change point and stroke position for the confirmation of proper press-fit mounting.

Management of press-fit points of press-fit parts

> Controller

Development focus:

Intuitive Dual Display

- 2-line digital display for unprecedented ease of use
- Full-fledged functions designed for optimum ease of operation on production floor

Industry's first*

* As of September 2015, in-company survey



Automotive applications



Lithium-ion battery flatness measurement



Coupling assembly inspection



Machined part height measurement



Installed height measurement

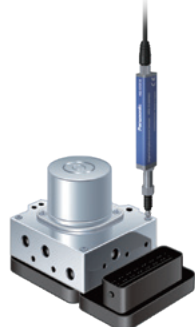

Screw head height measurement



Transmission parts height measurement

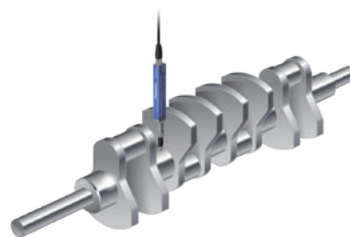

Crankshaft dimension measurement



Automotive parts dimension measurement

Sensor head

Robust and slim body contributes to a longer service life

The optical absolute method eliminates “value skipping” and “unset zero point”!

Robust and slim body

Slim & light body

Box type with an ultra-slim 11 mm **0.433 in** width. Furthermore, the unit weighs only approx. 80 g. ^(Note 1)

Note 1: Values on the 10 mm **0.394 in** type (HG-S1010□ / HG-S1110□)

Plain bearings with 2-point support structure

A new structure supports the spindle with upper and lower plain bearings to significantly increase rigidity. Unlike ball bearings, these bearings efficiently disperse lateral loads on the spindle, significantly reducing the risk of breakage.

18 mm
0.709 in
^(Note 1)

11 mm
0.433 in
^(Note 1)

84.5 mm
3.327 in
^(Note 1)

Bending-resistant cable

A bending-resistant cable provides peace of mind even when the sensor is installed on a movable tool.

Hot-swappable

The sensor head can be replaced without turning OFF the instrument power.

Metal guide whirl-stop structure



Spindle whirl-stop is accomplished by means of a metal guide requiring a several μm level assembly precision. Unlike a plastic guide, the risk of measurement error and glass scale breakage caused by deformation, wear, and other deterioration is significantly reduced.

Optical absolute method

No “value skipping” or “unset zero point”

Displacement is measured by reading a glass scale with a different slit pattern at each reading position using a high-resolution sensor. This eliminates “value skipping” even when measuring at high speed, and there is no concern of “unset zero point”.

Tip deviation amount of 35 μm **1.378 mil** or less (typical value) ^(Note 2)

[40 μm **1.574 mil** or less (typical value) on the HG-S1032 / HG-S1050 ^(Note 2)]

Tip deviation that reduces measurement precision is also minimized. Deviation of the measurement point is held to a minimum.

Note 2: Value calculated from the clearance of the upper and lower plain bearings.

Class-top accuracy

High-precision sensor head [HG-S1110□]

Resolution
0.1 μm
0.004 mil

Indication accuracy
Full range:
1.0 μm 0.039 mil or less
Narrow range:
0.5 μm 0.020 mil or less

Resolution
No. 1* in class

Indication accuracy
No. 1* in class

* As of January 2021, in-company survey.

Added Benefits

Air-driven type



Air-driven type sensor heads simplify equipment mechanisms.

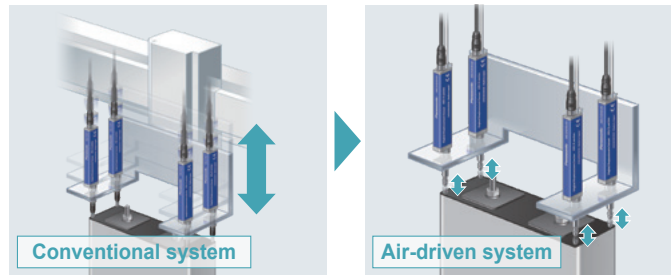

Supply and release of air moves the spindle up and down.

Eliminates the need for designing and installing a mechanism to move the sensor head up and down.

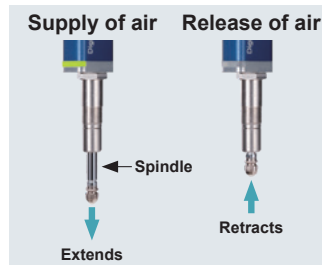

Compatible with low measuring force

Removal of the seal cap from the main unit allows measurement with low measuring force. The low probe contact force minimizes the possibility of workpiece damage.

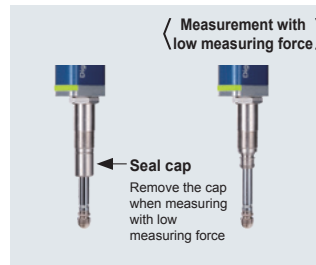

Advantages

- There is no need to design a mechanism for moving the sensor head. This eliminates the design cost and man-hours and improves equipment accuracy.
- Reduces installation spaces

High durability against lateral sliding load

Number of lateral sliding cycles: 10,000,000 or more (typical value) (under continuous testing)
The robust sensor head helps reduce damage caused by workpiece setup mistakes.

- Our original durability test against lateral sliding load

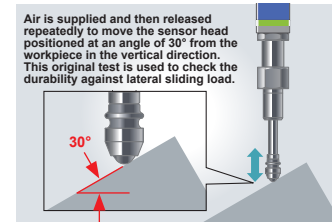

Regular type



Impressive durability

Resistance to lateral load

Original test was conducted to ensure durability against vertical sliding and lateral load that sensors are often subjected to in actual operations. There is a reason why you can use this product with peace of mind for a long time.

Durability to withstand more than 200 million vertical sliding operations (typical value) (Note 3)

Withstands more than 100 million sliding operations under application of lateral load (typical value) (Note 4)

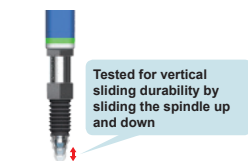

Note 3: Value on the HG-S1010 / HG-S1110.

Example of a lateral load occurring in the workplace

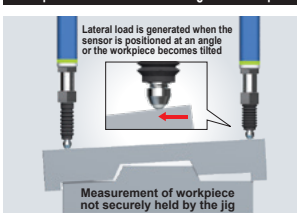

Notes: 4) Value on the HG-S1010 / HG-S1110.

5) Button-type probe for evaluation purposes was installed on the test sample for the lateral load resistance test.

Lateral load resistance test (Note 5)

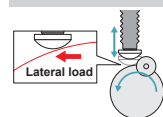

Hitting the spindle laterally with a roller. We conducted our own unique lateral load resistance testing <Test conditions>
Impact cycle: 13 times per second
Impact stroke: 1 mm 0.039 in

Lateral load resistance
No. 1* in class

* In the case of the HG-S1010 / HG-S1110
As of January 2021, in-company survey.

Resistance to shock and vibration

	10 mm 0.394 in type	32 mm 1.260 in type	50 mm 1.969 in type
Shock resistance	1,960 m/s ² acceleration in X, Y and Z directions three times each	1,960 m/s ² acceleration in X, Y and Z directions three times each	980 m/s ² acceleration in X, Y and Z directions three times each
Vibration resistance	10 to 500 Hz frequency, 3 mm 0.118 in double amplitude (10 to 58 Hz), Maximum acceleration 196 m/s ² (58 to 500 Hz) in X, Y and Z directions for two hours each	10 to 150 Hz frequency, 3 mm 0.118 in double amplitude (10 to 58 Hz), Maximum acceleration 196 m/s ² (58 to 150 Hz) in X, Y and Z directions for two hours each	10 to 55 Hz frequency, 1.5 mm 0.059 in double amplitude in X, Y and Z directions for two hours each

Vibration / shock resistance
No. 1* in class

* In the case of the 10 mm 0.394 in type / 32 mm 1.260 in type
As of January 2021, in-company survey.

Resistant to upward thrust impact

Spindle stopper installed
Even if unexpected upward thrust occurs, the lower part of the spindle blocks the impact. Damage to the internal structure, including the glass scale, is minimized.



Hot-swappable

Change of sensor head without turning off the power supply

The sensor head can be changed safely without turning off the controller. This reduces the man-hours required for the change of line setup for processing of different workpieces, thus achieving a significant reduction of setup change time.

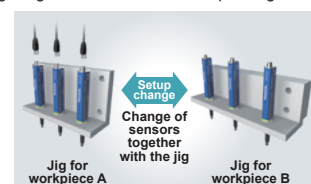

Controller

Versatile and Easy-to-Use Controller

The controller features the industry's first* dual display and offers versatile functions and excellent ease of use. It allows simple and reliable operation of the advanced measurement function in a diversity of applications.

Industry's first!*

* As a sensor product using optical absolute method, as of September 2015 (according to in-company survey)

Dual display for added indication flexibility (equipped with NAVI function)

The 2-line digital display simultaneously shows head measurement (measured value) and judgment value (calculated value).

High-speed response of 3 ms in combination with any sensor head

All-direction LCD

The high-contrast LCD provides sharp and clear indications and wide viewing angle.

Equipped with intuitive circle meter

Values between allowable maximum and minimum values are indicated in green. Values outside of the allowable range are indicated in orange. This provides at-a-glance understanding of the margin to the tolerance limits.



Higher than maximum value

Lower than minimum value

Anytime selection of function to copy

The selective copy function significantly reduces the man-hours required for initial setting and maintenance.



Provided with maintenance mode useful on production floor

The following data is saved in the memory. The stored data can be used effectively for on-site analysis.

- Maximum peak value during operation
- Number of times maximum stroke was exceeded
- Cumulative spindle moving distance (m)

Alarm setting for notification of upward thrust

Alarm can be set to notify the user when upward thrust (stroke) exceeds the value set by the user.

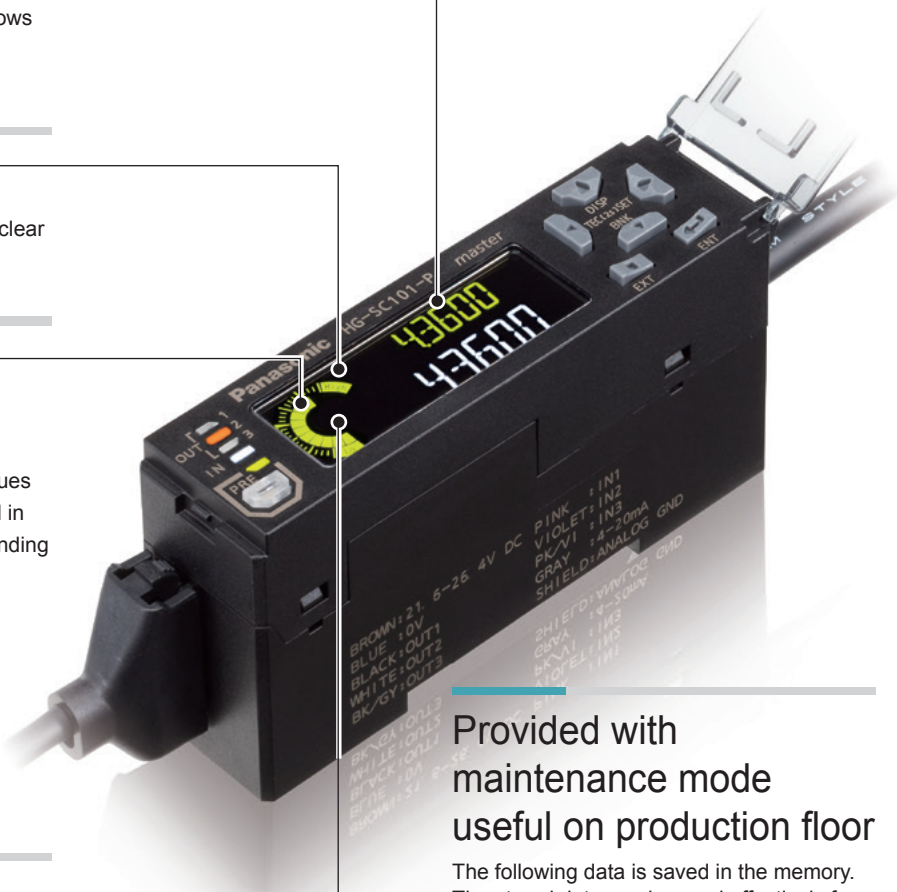

Easy-to-understand 2-line digital display

The 2-line digital display simultaneously shows sensor head measurement and judgment value.

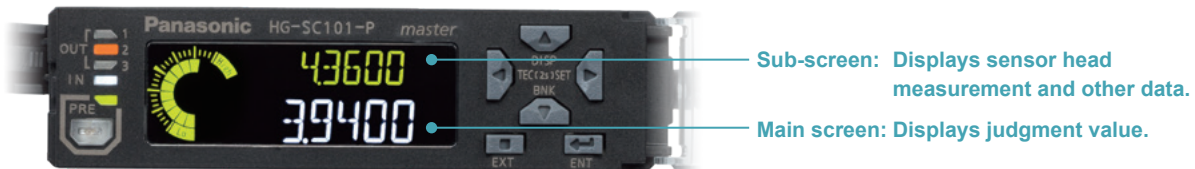

Easy tolerance setting

Simple 1-point teaching

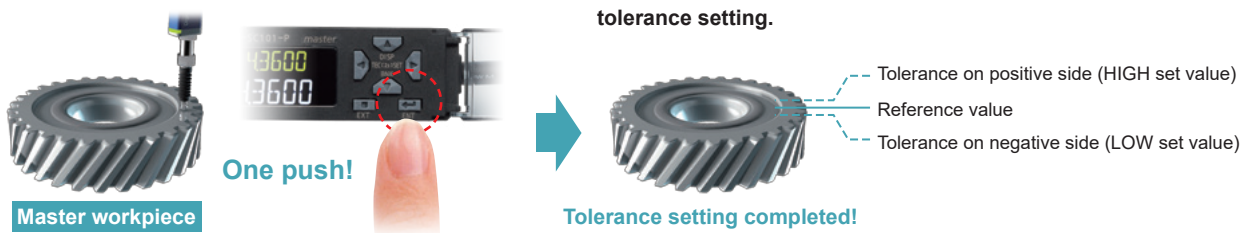

No need for trigger input

Equipped with self-trigger hold function

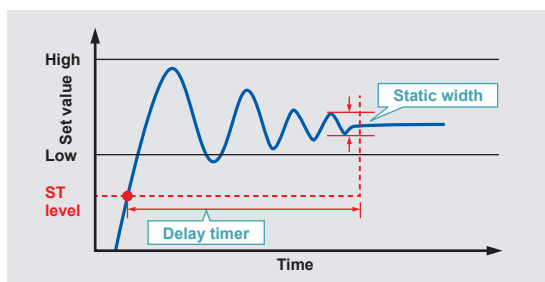

Easy setting of time length from measurement start to measurement stabilization. Minimizes measurement fluctuation due to the vibration caused by stopping of spindle rotation.

(1) Static width setting

Stability range above the ST level can be set as desired. Set the range where measurements are considered to be stable.

(2) Delay timer setting

Desired delay time after measurement exceeding the ST level can be set. Set the time required for stabilization of measurement.

Controller

Lateral connection of slave units for added operational ease

Connection of up to 15 slaves units

(Example: Connection of 15 slave units)

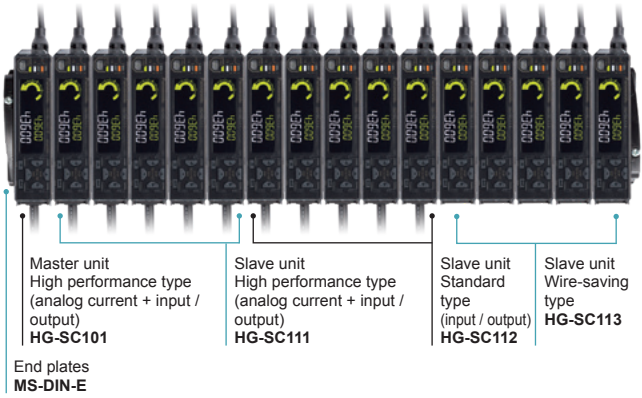

*End plates (optional) must be mounted on both sides of the controller after the connection of slave units.

One master unit can be connected with up to 15 slave units in any order. This allows easy multi-point calculations.

* When a digital displacement sensor communication unit is connected, a maximum of 14 slave units can be connected per master unit.

Controller variations

- **Master unit (1 model)**
 - High performance type (analog current + input / output)
- **Slave unit (3 models)**
 - High performance type (analog current + input / output)
 - Standard type (input / output)
 - Wire-saving type

Hold function (9 types)

Sample hold (S-H)	Peak hold (P-H)	Bottom hold (B-H)
Peak-to-peak hold (P-P)	Peak-to-peak hold/2 (P-P/2)	
NG hold (NG-H)	Self-sample hold (SLF.S-H)	
Self-peak hold (SLF.P-H)	Self-bottom hold (SLF.B-H)	

Calculation function (8 types)

MAX (maximum value)	MIN (minimum value)	FLAT (flatness)
AVERAG (average value)	STAND (reference difference)	
TORSIN (torsion)	CURVEA (curvature)	THICK (thickness)

Connectable to thru-beam type digital displacement sensor **HG-T** series

When the HG-SC□¹ controller is combined with the HG-TC□¹ controller for thru-beam type digital displacement sensor HG-T series, up to 15 slave units (up to 14 slave units if communication unit for digital displacement sensors is connected) can be connected to one master unit.

Connect the same-series slave units close to the master unit and connect slave units of other series on the far side.

¹ Be sure to use controllers manufactured in or after February 2019.

<Example: Connection of 8 units of HG-T series to 8 units of HG-S series (NPN output type)>

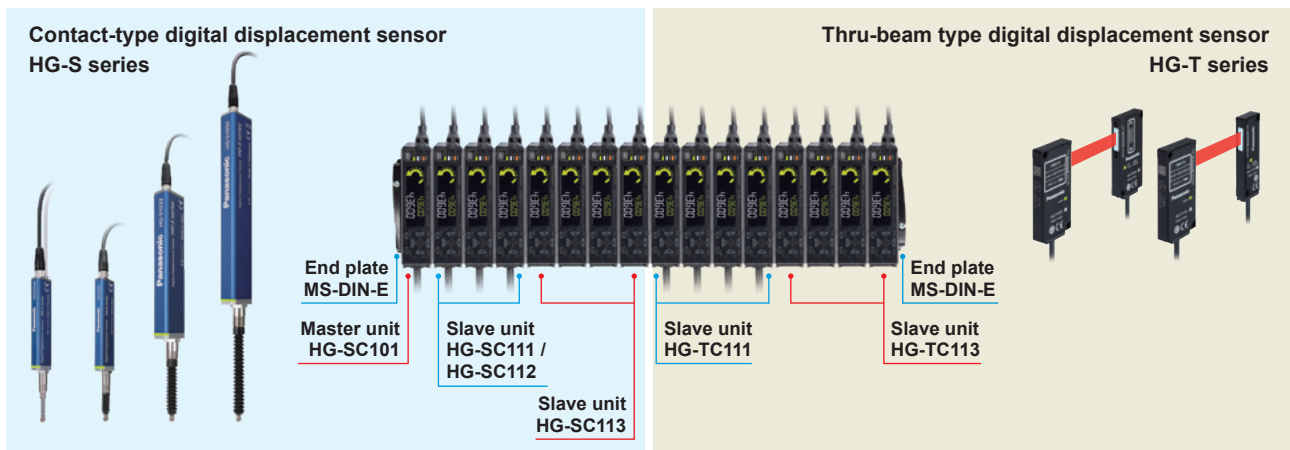

* When connecting slave units to a master unit, connect only NPN output types, or only PNP output types. Dissimilar output types cannot be connected together.

* After the connection, attach end plates (optional) to both ends of the controller for secure installation.

* If HG-SC□ and HG-TC□ controllers are used in combination, there are limitations on the functions below.

Item	Description of limitation
Calculation function	Calculation is only performed when the slave unit is the same series as the master unit. Calculation is not performed when the slave unit series is different from the master unit series. "CALC" does not appear in the display of a slave unit of a different series.
Input all	The master unit only performs input all when the slave units are the same series. A slave unit of a different series from the master unit does not perform input even when the external input settings match those of the master unit.
Copy function	Copying is only performed when the slave unit is the same series as the master unit. When copying is executed, "NOW COPY" appears even on the display of a slave unit of a different series from the master unit, but copying is not performed.

Thru-beam type digital displacement sensor

Thru-beam type digital displacement sensor
HG-T series

CMOS Type

Self-Monitoring Sensor

CE

FDA

The industry's highest-class*¹ measurement accuracy is now yours.

Sensor head

Ultra-slim



- Measurement width: 10 mm 0.394 in
- Installation distance: 0 to 500 mm 0 to 19.685 in
- Laser class: Class 1 (JIS / IEC / GB / FDA²)

■ The belt-shaped laser beam with a measurement width of 10 mm 0.394 in is used for measurement of dimensions and positions.

■ The HG-T series boasts repeatability³ of 1 μm 0.039 mil⁴ and offers the highest*¹ measurement accuracy in the industry.

*1: As a thru-beam type sensor. As of January 2021, in-company survey.
*2: Conformance with 21 CFR 1040.10 and 1040.11 Laser Notice No. 50, dated June 24, 2007, issued by CDRH (Center for Devices and Radiological Health) under the FDA (Food and Drug Administration).
*3: This is the P-P value of digital measurement value with half shading at the middle position of the installation distance.
*4: When installation distance is 20 mm 0.787 in

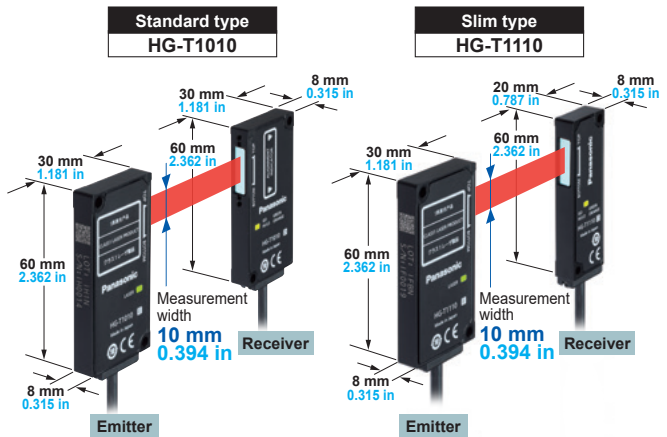

- Two types of sensor heads are available.
- Side view attachment is available (optional). [for HG-T1010]
- Beam axis adjustment assist function for easy setup of emitter and receiver
- Automatic emitter / receiver cable recognition for simplified connector connection
- Lightweight and robust die-cast aluminum case
- Protection structure IP67 (IEC)

Controller

High-performance

- Dual display for added indication flexibility (equipped with NAVI function)
- All-direction LCD
- Equipped with intuitive circle meter



- Six types of detection modes
 - (1) Auto edge detection mode
 - (2) User assigned edge detection mode
 - (3) Edge detection mode
 - (4) Inside diameter / gap detection mode
 - (5) Outer diameter / width detection mode
 - (6) Central position detection mode
- Monitoring of effects caused by stains
- Stable measurement of even transparent workpieces
- Elimination of effects caused by fine foreign matters
- Disable abrupt measurement changes
- Equipped with 5 arithmetic functions
 - (1) Maximum value
 - (2) Minimum value
 - (3) Average value
 - (4) Reference value
 - (5) Thickness / width
- Connectable to contact-type digital displacement sensor HG-S series

Communication unit for digital displacement sensors

Compatible with self-monitoring function

Suitable for use on manufacturing lines **Sensor equipped with a new self-monitoring function!**

A sensor with a self-monitoring function diagnoses its own state and notifies when readjustment of settings / setup is required or when maintenance is needed.

The sensor determines its status and indicates "Normal," "Notification," "Caution" or "Fault." When not in normal status, the sensor checks the cause of problem and corrective measure, thus reducing equipment downtime and maintenance workload.

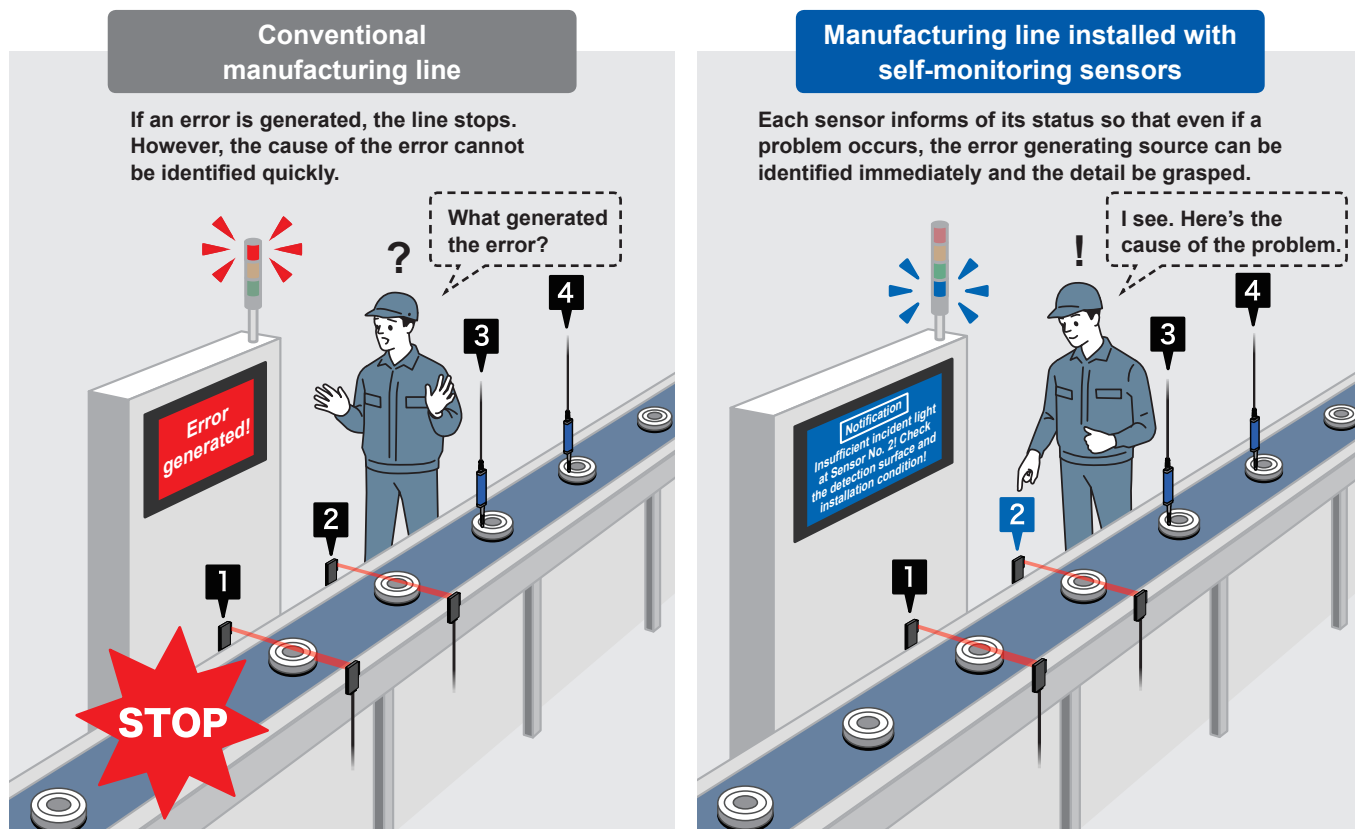

Self-monitoring function: Four types of status indication and judgment of state

Status	Judgement of the state
Normal	Operation is normal.
Notification	Check the settings. Detected state is unstable. * Recover to the normal state through checking installation and settings. Reduction in the incident light intensity.
Caution	Getting close to the end of service life. Reached the state where the device should be replaced. * Limitation in the writing frequency into the memory or in the operation hours, etc.
Fault	Short-circuited or broken. Reached the state where it is impossible to control as a device. * Short-circuited output, damaged EEPROM, etc.

Example of a system that utilizes the self-monitoring function

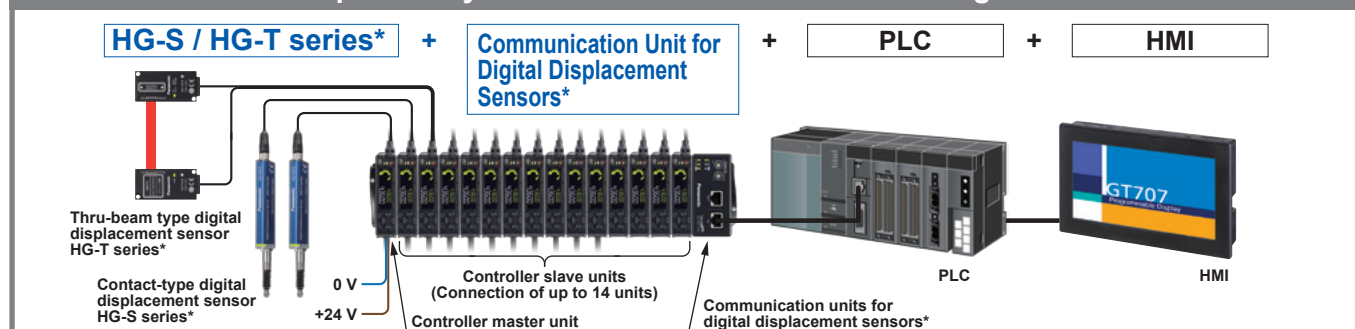

* To use the self-monitoring function with the contact-type digital displacement sensors HG-S series and thru-beam type digital displacement sensors HG-T series, a communication unit for digital displacement sensors (any of the following: SC-HG1-ETC, SC-HG1-CEF, SC-HG1-C or SC-HG1-485) that supports the self-monitoring function is required.

Identification of malfunctioning location and cause

The sensor self-diagnoses its state, so if a malfunction occur, it is easy to identify the problem location and discover the cause of the problem. Therefore, even if there is no experienced worker or skilled technician at the site to respond to the problem, it is possible to take an appropriate measure immediately. This minimizes the restoration time and reduces the maintenance workload.

Reduction of downtime

Reduction of maintenance workload



Easy planning of maintenance schedule

Conventional sensors can generate unexpected malfunctions and require many hours for maintenance and replacement; thus, an unscheduled shutdown of the manufacturing line may be required from time to time. The self-monitoring function notifies the sensor replacement timing, thus allowing for planning the most efficient maintenance and replacement schedule. This helps prevent unexpected shutdowns of the manufacturing line and improves productivity.

Improved productivity

Predictive maintenance

■ Details of self-monitoring function

HG-S series' self-monitoring function				
Status	Response parameter	Measures	Controller HG-SC□	
			Error code (Note)	Measurement alarm (Note)
Notification	Sensor head unconnected	Status check	E200	—
	Connected unit count check error	Status check	E160 (For master units only)	—
	NPN / PNP output type mixture error	Status check	E100 (For master units only)	—
	Calculated unit count error	Status check	E110 (For master units only)	—
	Copy execution error (slave unit problem)	Status check	E170 (For master units only)	—
	Sensor head receiving upward thrust exceeding the specification stroke range	Status check	E210	—
	Check for upward thrust	Status check	—	Alarm
	Check for sticky movement	Status check	—	Alarm
Fault	Controller memory function damaged	Controller replacement	E600	—
			E610	
			E620	
	Sensor Head memory function damaged	Sensor head replacement	E630	—
	Output section short-circuit error	Status check / Replacement	E700	—
	Detection circuit damaged	Sensor head replacement	E240	—
	System error	Controller replacement	E900	—
			E910	
E911				
E912				
			E920	

Note: Error codes and alarms are displayed on HG-SC□ controllers.

Communication unit for digital displacement sensors

Compatible with self-monitoring function

Direct transfer of measurement data obtained by multiple sensors to host device!

CC-Link IE Field Communication Unit / CC-Link Communication Unit

Compatible with self-monitoring function

Use of our communication unit for digital displacement sensors allows direct connection to the CC-Link / CC-Link IE Field network.

This enables real-time acquisition of digital data and ON / OFF information without any program.

Furthermore, it can be used to change controller settings and log measurement data via CC-Link / CC-Link IE Field network, for example, for predictive maintenance of digital displacement sensors.

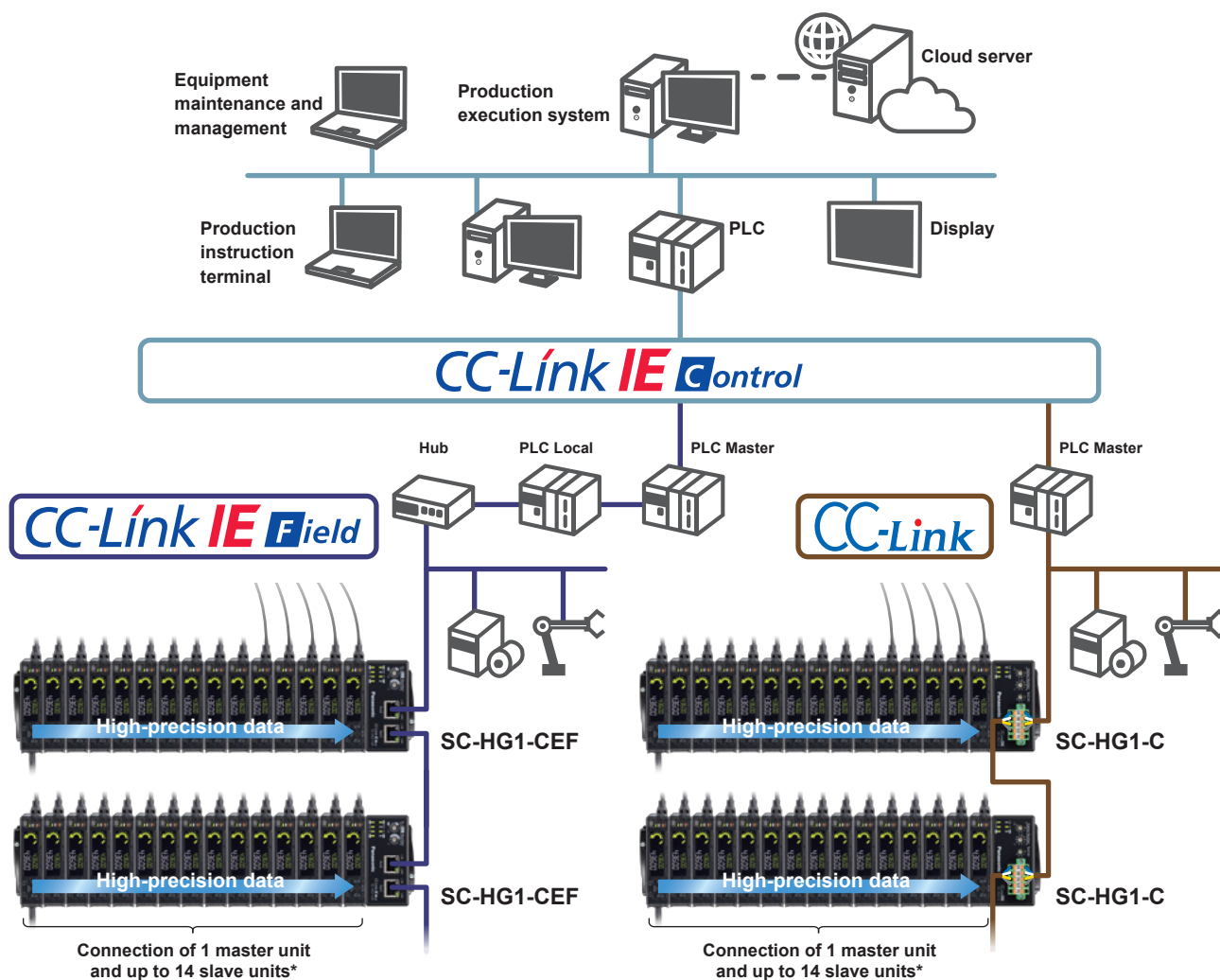

* When connected to a communication unit for digital displacement sensor, up to 14 slave units can be connected per master unit.

CC-Link IE Field communication unit
SC-HG1-CEF



CC-Link IE Field
Communication speed: 1 Gbps

* Units shipped in and after December 2019 are compatible with self-monitoring function.

CC-Link communication unit
SC-HG1-C



CC-Link Supports iQSS
Communication speed: 10 Mbps (max.)

* Units manufactured in and after December 2019 are compatible with self-monitoring function.

* CC-Link IE Field and CC-Link are trademarks of Mitsubishi Electric Corporation, and are controlled by the CC-Link Partner Association.

EtherCAT Communication Unit

Compatible with self-monitoring function

Our product line also includes a communication unit that enables connection with EtherCAT. This unit communicates measurement (judgment) data and error codes cyclically at a high-speed sampling rate and transfers the data to the host device with accuracy intact. Furthermore, settings of multiple sensors can be read and written, and the bank can be switched via EtherCAT.

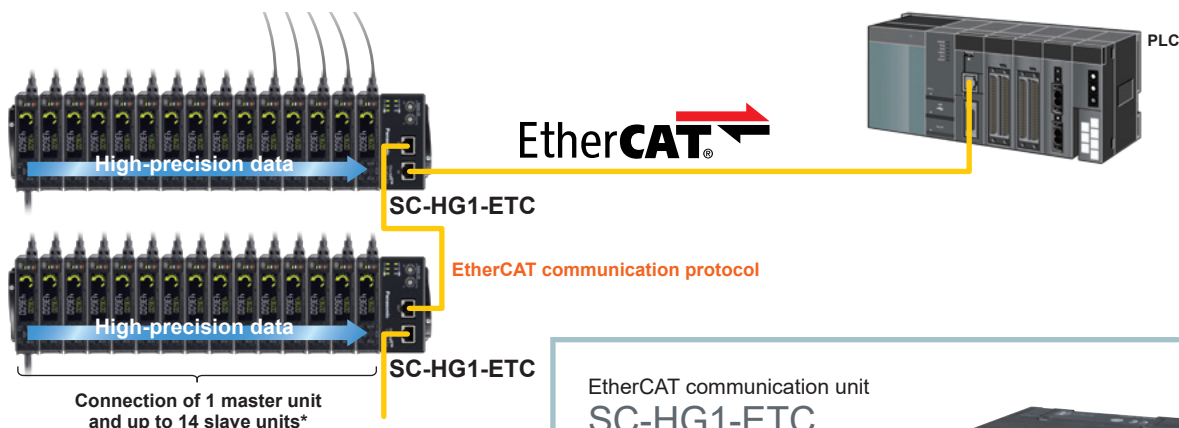

Connection of 1 master unit and up to 14 slave units*

* When connected to a communication unit for digital displacement sensor, up to 14 slave units can be connected per master unit.

EtherCAT communication unit
SC-HG1-ETC

EtherCAT

Communication speed: 100 Mbps (100BASE-TX)

* Supports the self-monitoring function regardless of the manufacturing date.

* EtherCAT is a registered trademark patent-protected technology, licensed by Beckhoff Automation GmbH of Germany.

RS-485 Communication Unit

Compatible with self-monitoring function

For use of high-precision measurement results as traceability data. Transfers not only measurements results obtained at multiple points but also setting statuses as digital data in a batch. Provides powerful support to the management of inspection records and identification of failure causes.

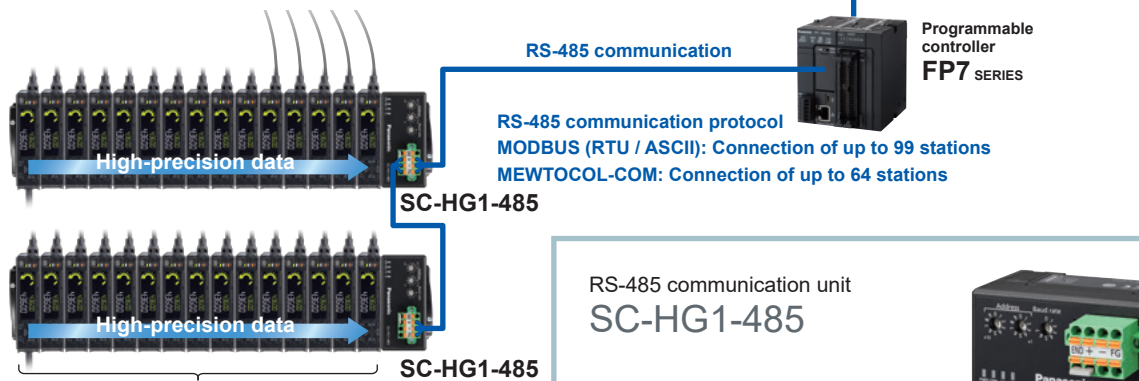

Connection of 1 master unit and up to 14 slave units*







* When connected to a communication unit for digital displacement sensor, up to 14 slave units can be connected per master unit.

RS-485 communication unit
SC-HG1-485

Communication speed: 1.2 kbps / 2.4 kbps / 4.8 kbps / 9.6 kbps / 19.2 kbps / 38.4 kbps / 57.6 kbps / 115.2 kbps

* Units manufactured in and after November 18 2019 are compatible with self-monitoring function.



Sensor heads

Type		Appearance		Measurement range	Resolution	Model No.	
Air-driven type (Note 1)	10 mm 0.394 in type	General purpose	General purpose 10 mm 0.394 in type 	10 mm 0.394 in (Note 2)	0.5 μm 0.020 mil	HG-S1010-AC	
		High precision	High precision 10 mm 0.394 in type 		0.1 μm 0.004 mil	HG-S1110-AC	
Regular type	10 mm 0.394 in type	General purpose	Standard	General purpose 50 mm 1.969 in type  High precision 32 mm 1.260 in type  10 mm 0.394 in type  10 mm 0.394 in type 	10 mm 0.394 in	0.5 μm 0.020 mil	HG-S1010
			Low measuring force			0.1 μm 0.004 mil	HG-S1010R
		High precision	Standard			0.1 μm 0.004 mil	HG-S1110
			Low measuring force			0.1 μm 0.004 mil	HG-S1110R
	32 mm 1.260 in type	General purpose	Standard		32 mm 1.260 in	0.5 μm 0.020 mil	HG-S1032
	50 mm 1.969 in type (Note 1)	General purpose	Standard		50 mm 1.969 in	0.5 μm 0.020 mil	HG-S1050

Notes: 1) Be sure to use the sensor in combination with an **HG-SC** controller manufactured in or after February 2019.

2) The position that represents "0" as an absolute value is a position where the spindle is pushed further down from the bottom dead point by 0.1 mm 0.004 in or more.



Sensor head connection cables (bending-resistant type)

Type	Appearance	Cable length	Model No.
Straight connector		3 m 9.843 ft	CN-HS-C3
		7 m 22.966 ft	CN-HS-C7
		10 m 32.808 ft	CN-HS-C10
		20 m 65.617 ft	CN-HS-C20
L-shaped connector (Note)		3 m 9.843 ft	CN-HS-C3L
		7 m 22.966 ft	CN-HS-C7L
		10 m 32.808 ft	CN-HS-C10L
		20 m 65.617 ft	CN-HS-C20L

Note: Not compatible with air-driven type sensor heads (**HG-S1010-AC** / **HG-S1110-AC**)





ORDER GUIDE

Controllers

Type		Appearance	Model No.	Output	Number of connectable controllers
Master unit	High performance type (analog current + input / output)		HG-SC101	NPN open-collector transistor	Up to 15 slave units can be connected per master unit. (Note)
			HG-SC101-P	PNP open-collector transistor	
Slave unit	High performance type (analog current + input / output)		HG-SC111	NPN open-collector transistor	
			HG-SC111-P	PNP open-collector transistor	
	Standard type (input / output)		HG-SC112	NPN open-collector transistor	
			HG-SC112-P	PNP open-collector transistor	
Wire-saving type		HG-SC113	—		

Note: When connected to a communication unit for digital displacement sensor, up to 14 slave units can be connected per master unit

Communication units for digital displacement sensors

Type	Appearance	Model No.	Description
CC-Link IE Field communication unit Compatible with self-monitoring function (Note 1)		SC-HG1-CEF	Can directly send high-precision measurement values to a CC-Link IE Field host device. <ul style="list-style-type: none"> Communication method: CC-Link IE Field Number of connected units Host (CC-Link IE Field): Max. 121 units (1 master station, 120 slave stations) Controllers: Maximum of 15 units (1 master, 14 slaves) per SC-HG1-CEF unit
CC-Link communication unit Compatible with self-monitoring function (Note 1)		SC-HG1-C	Can directly send high-precision measurement values to CC-Link Master. <ul style="list-style-type: none"> Communication method Switchable CC-Link Ver.1.10 or 2.00 Number of occupied station CC-Link Ver.1.10: 4 stations, CC-Link Ver.2.00: Switchable 2 or 4 stations Number of connected units Controllers: Maximum of 15 units (1 master, 14 slaves) per SC-HG1-C unit
EtherCAT communication unit Compatible with self-monitoring function (Note 1)		SC-HG1-ETC	Can directly send high-precision measurement values to EtherCAT Master. <ul style="list-style-type: none"> Communication protocol: EtherCAT Number of connected units Controllers: Maximum of 15 units (1 master, 14 slaves) per SC-HG1-ETC unit
RS-485 communication unit Compatible with self-monitoring function (Note 1)		SC-HG1-485	Can directly send high-precision measurement values by RS-485 communication. <ul style="list-style-type: none"> Communication protocol: MODBUS (RTU / ASCII) / MEWTOCOL-COM Number of connected units Host (RS-485): 1 to 99 units when MODBUS (RTU / ASCII) is used, 1 to 64 units when MEWTOCOL-COM is used Controllers: Maximum of 15 units (1 master, 14 slaves) per SC-HG1-485 unit

Notes: 1) The following products support the self-monitoring function:









SC-HG1-CEF: Products shipped in and after December 2019, **SC-HG1-C**: Products manufactured in and after December 2019, **SC-HG1-ETC**: All, **SC-HG1-485**: Products manufactured on and after November 18, 2019.

2) USB communication unit **SC-HG1-USB** cannot be used with the **HG-S** series contact-type digital displacement sensors.

End plates

Type	Appearance	Model No.	Description
End plates		MS-DIN-E	End plates are used to securely hold the controller and communication unit for digital displacement sensors connected on a DIN rail by pressing from both ends. Be sure to use the end plates when connecting units. <u>2 pcs per set</u>

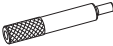
OPTIONS

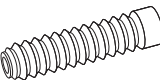
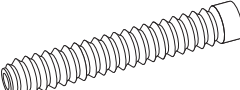
Type	Appearance	Model No.	Description
Computer software for CC-Link IE Field / CC-Link		SC-PC1	This software makes it possible to use a computer to monitor current sensor values, save setting information to a CSV file, display log data, save log data to a CSV file, etc. <ul style="list-style-type: none"> Compatible communication units for digital displacement sensors: SC-HG1-CEF, SC-HG1-C Compatible OS: Microsoft Windows® 7 (32 bit), Japanese version Required HDD space: 50 MB or more
Probe		NEW HG-SS10C×5	Standard type 5 pcs per set
		NEW HG-SS10H	Super-hard type
		NEW HG-SS20H	Super-hard needle type
		NEW HG-SS30S	Flat-seated type
		NEW HG-SS40U	Roller type (Note1)
Joint (Note1)(Note2)		NEW HG-SJ15	Length 15 mm 0.591 in type
		NEW HG-SJ25	Length 25 mm 0.984 in type
Rubber bellows		NEW HG-SGN10×5	Regular type, 10 mm 0.394 in type sensor head 5 pcs per set
		NEW HG-SGN32×5	Regular type, 32 mm 1.260 in type sensor head 5 pcs per set
		NEW HG-SGN50×5	Regular type, 50 mm 1.969 in type sensor head 5 pcs per set

Notes: 1) The joint (optional) cannot be used if a low-measuring-force type sensor head (**HG-S1010R, HG-S1110R**) is installed laterally and the **HG-SS40U** roller-type probe (optional) is used.
 2) Only one joint (optional) can be installed to one sensor head.
 3) Microsoft and Windows are registered trademarks or trademarks of Microsoft Corporation in the United States.

Service parts (provided with air-driven type sensor heads)

Type	Appearance	Model No.	Description
Seal cap		HG-SASC×5	This seal cap is for air-driven 10 mm 0.394 in type sensor head. As part of preventive maintenance, replace the seal cap before the internal O-ring wears out. Replace the seal cap at an appropriate time (after about 5 million sliding operations) according to the degradation condition of the installed seal material. 5 pcs per set

SPECIFICATIONS

Sensor heads (Air-driven type)

Type	Air-driven type				
	10 mm 0.394 in type				
Model No.	General purpose		High precision		
	HG-S1010-AC		HG-S1110-AC		
Item	With no seal cap mounted		With no seal cap mounted		
Regulatory compliance	EMC Directive, RoHS Directive				
Compatible controller (Note 2)	HG-SC101(-P), HG-SC111(-P), HG-SC112(-P), HG-SC113				
Position detection method	Optical absolute linear encoder method				
Measurement range	10 mm 0.394 in (Note 3)				
Stroke	10.5 mm 0.413 in or more (Note 3)				
Measuring force (Note 4)	Downward mount: (Note 5), Upward mount: (Note 5), Side mount: (Note 5)				
Resolution	0.5 μm 0.02 mil		0.1 μm 0.004 mil		
Sampling cycle	1 ms				
Indication accuracy (P-P)	Full range: 2.0 μm 0.079 mil or less Limited range: 1.0 μm 0.039 mil or less (any 60 μm 2.362 mil)		Full range: 1.0 μm 0.039 mil or less Limited range: 0.5 μm 0.02 mil or less (any 60 μm 2.362 mil)		
Tip deviation amount	35 μm 1.378 mil (typical value)				
Hot swap function	Incorporated				
Working pressure range	0.14 to 0.16 MPa	0.035 to 0.045 MPa	0.14 to 0.16 MPa	0.035 to 0.045 MPa	
Capacity to resist pressure	0.2 MPa				
Usable fluid	Clean air (Dew point temperature: -10 °C +14 °F or less)				
Applicable tube	Outside diameter: ø4 mm ø0.157 in / Inside diameter: ø2.5 mm ø0.098 in				
Operation indicator	Equipped (2-color LED: Orange / Green)				
Pollution degree	2				
Operating altitude	2,000 m 6561.68 ft or less (Note 6)				
Environmental resistance	Protection	IP67 (IEC) (Note 7)	—	IP67 (IEC) (Note 7)	—
	Ambient temperature	-10 to +55 °C +14 to +131 °F (No dew condensation or icing allowed), Storage: -20 to +60 °C -4 to +140 °F			
	Ambient humidity	35 to 85 % RH, Storage: 35 to 85 % RH			
	Insulation resistance	100 MΩ or more at 250 V DC			
	Vibration resistance	10 to 500 Hz frequency, 3 mm 0.118 in double amplitude (10 to 58 Hz), maximum acceleration 196 m/s ² , (58 to 500 Hz) in X, Y, and Z directions for two hours each			
	Shock resistance	1,960 m/s ² acceleration in X, Y, and Z directions three times each			
Grounding method	Capacitor grounding				
Material	Body: Zinc, Holder: Stainless steel, Spindle: Tool steel, Probe (Note 8): Brass (body) / Ceramic (ball), Air tube clamp: S60CM				
Weight	Net weight: 80 g approx.				
Accessories	Sensor head fastening wrench: 1 pc., Mounting nut: 1 pc., Seal cap: 1pc, Air tube clamp: 1 pc.				

- Notes: 1) Where measurement conditions are not specified, the conditions used were as follows: standard type measurement probe (HG-SS10C), ambient temperature of +20 °C +68 °F, and a clean atmosphere where water, oil, other liquids or dust does not come in contact with the equipment.
 2) Be sure to use the sensor in combination with an HG-SC□ controller manufactured in or after February 2019.
 3) The position that represents "0" as an absolute value is a position where the spindle is pushed further down from the bottom dead point by 0.1 mm 0.004 in or more. The term "stroke" indicates the total stroke length from the bottom dead point to the top dead point.
 4) Measuring force changes with the air pressure used. Removing the seal cap enables the product to be used as the low measuring force type.
 5) For the relationship between supplied air pressure and measuring force or between measuring force and pushed spindle position, see the figures below. For upward mount without a seal cap, subtract 0.2 N from the measuring force. For side mount, subtract 0.1 N from the measuring force. The following figures are only typical examples, and these relationships differ depending on the assembly accuracy of the product or the abrasion status of sealing materials.

<Downward mount (typical example)>

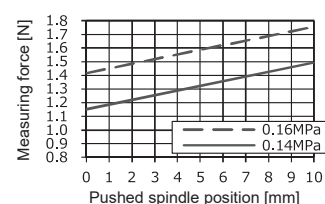

<Downward mount (typical example)>

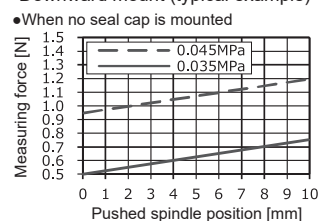

<Upward mount (typical example)>

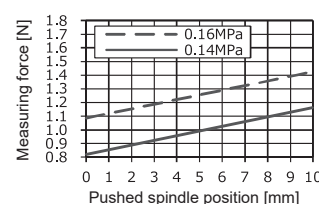

<Side mount (typical example)>

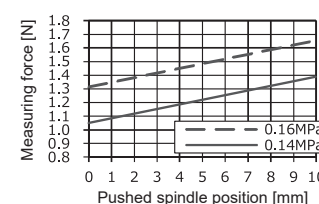

- 6) Do not use or store in an environment that has been pressurized to an air pressure higher than the atmospheric pressure at 0 m.
 7) Protective structure is not applicable when the sealing portions have deteriorated or become damaged. The protection level is zero when the seal cap is removed.
 8) The probe is also available as an option.

SPECIFICATIONS

Sensor head (Regular type)

Item \ Model No.		Regular type					
		10 mm 0.394 in type				32 mm 1.260 in type	50 mm 1.969 in type
		General purpose		High precision		General purpose	General purpose
		Standard	Low measuring force	Standard	Low measuring force	Standard	Standard
Model No.		HG-S1010	HG-S1010R	HG-S1110	HG-S1110R	HG-S1032	HG-S1050
Regulatory compliance		EMC Directive, RoHS Directive					
Compatible controller (Note 2)		HG-SC101(-P), HG-SC111(-P), HG-SC112(-P), HG-SC113					
Position detection method		Optical absolute linear encoder method					
Measurement range		10 mm 0.394 in				32 mm 1.260 in	50 mm 1.969 in
Stroke		10.5 mm 0.413 in or more				32.5 mm 1.280 in or more	50.5 mm 1.988 in or more
Measuring force (Note 3)	Downward mount	1.65 N or less 1.10 N (Note 4)	0.35 N or less 0.30 N (Note 4)	1.65 N or less 1.10 N (Note 4)	0.35 N or less 0.30 N (Note 4)	2.97 N or less 1.90 N (Note 4)	3.8 N or less (50 mm 1.969 in in pressing position) 1.9 N (intermediate position) (Note 4)
	Upward mount	1.35 N or less 0.85 N (Note 4)	—	1.35 N or less 0.85 N (Note 4)	—	2.09 N or less 1.19 N (Note 4)	3.2 N or less (50 mm 1.969 in in pressing position) 1.4 N (intermediate position) (Note 4)
	Side mount	1.50 N or less 0.95 N (Note 4)	0.25 N or less 0.20 N (Note 4)	1.50 N or less 0.95 N (Note 4)	0.25 N or less 0.20 N (Note 4)	2.53 N or less 1.50 N (Note 4)	3.4 N or less (50 mm 1.969 in in pressing position) 1.7 N (intermediate position) (Note 4)
Resolution		0.5 µm 0.020 mil		0.1 µm 0.004 mil		0.5 µm 0.020 mil	
Sampling period		1 ms					
Indication accuracy (P-P)		Full range: 2.0 µm 0.079 mil or less Narrow range: 1.0 µm 0.039 mil or less (any 60 µm 2.362 mil)		Full range: 1.0 µm 0.039 mil or less Narrow range: 0.5 µm 0.020 mil or less (any 60 µm 2.362 mil)		Full range: 3.0 µm 0.118 mil or less Narrow range: 2.0 µm 0.079 mil or less (any 60 µm 2.362 mil)	Full range: 3.5 µm 0.138 mil or less
Tip deviation amount		35 µm 1.378 mil (typical) (Note 5)				40 µm 1.575 mil (typical) (Note 5)	
Hot swap function		Incorporated					
Operation indicator		2-color LED (Orange / Green)					
Pollution degree		2					
Operating altitude		2,000 m 6561.68 ft or less (Note 6)					
Environmental resistance	Protection	IP67 (IEC) (Note 7)	—	IP67 (IEC) (Note 7)	—	IP67 (IEC) (Note 7)	
	Ambient temperature	-10 to +55 °C +14 to +131 °F (No condensation or icing), Storage: -20 to +60 °C -4 to +140 °F					
	Ambient humidity	35 to 85 % RH, Storage: 35 to 85 % RH					
	Insulation resistance	100 MΩ or more at 250 V DC					
	Vibration resistance	10 to 500 Hz frequency, 3 mm 0.118 in double amplitude (10 to 58 Hz), maximum acceleration 196 m/s ² , (58 to 500 Hz) in X, Y, and Z directions for two hours each				10 to 150 Hz frequency, 3 mm 0.118 in double amplitude (10 to 58 Hz), maximum acceleration 196 m/s ² , (58 to 150 Hz) in X, Y, and Z directions for two hours each	10 to 55 Hz frequency, 1.5 mm 0.059 in double amplitude, X, Y, and Z directions for two hours each
Shock resistance	1,960 m/s ² acceleration in X, Y and Z directions three times each				1,960 m/s ² acceleration in X, Y and Z directions three times each	980 m/s ² acceleration in X, Y and Z directions three times each	
Grounding method		Capacitor grounding					
Material	Body	Zinc				Aluminum alloy	Aluminum alloy
	Holder	Stainless steel				Stainless steel	Free-cutting steel
	Spindle	Tool steel				Free-cutting steel	Carbon tool steel
	Probe (Note 8)	Brass (body) / Ceramic (ball)					
	Rubber bellows	NBR (black)					
Weight		Net weight: 80 g approx.				Net weight: 150 g approx.	Net weight: 180 g approx.
Accessories		Standard type (HG-S1010 / HG-S1110 / HG-S1032 / HG-S1050): Sensor head fastening wrench 1 pc., Mounting nut 1 pc. Low measuring force type (HG-S1010R / HG-S1110R): Sensor head fastening wrench 1 pc., Mounting nut 1 pc., Rubber bellows 1 pc.					

- Notes: 1) Where measurement conditions have not been specified precisely, the conditions used were as follows: standard type measurement probe (HG-SS10C), ambient temperature +20 °C +68 °F, and a clean atmosphere where dust and liquids such as water and oil do not come in contact with the equipment.
 2) In the case of the 50 mm 1.969 in type (HG-S1050), be sure to connect to an HG-SC□ controller product manufactured in or after February 2019.
 3) In the case of low measurement force type (HG-S1010R / HG-S1110R), measurements were obtained with products in standard configuration without rubber bellows.
 4) Typical value near center of measurement.
 5) Value calculated from the clearance of the upper and lower plain bearings.
 6) Do not use or store in an environment that has been pressurized to an air pressure higher than the atmospheric pressure at 0 m.
 7) Excludes damage and deterioration to rubber bellows due to external causes.
 8) The probes (optional) are also available.

SPECIFICATIONS

Controllers

Item	Model No.	Type	Master unit		Slave unit		
			High-performance type		High-performance type	Standard type	Wire-saving type
			NPN output	PNP output	HG-SC101	HG-SC111	HG-SC112
Regulatory compliance			EMC Directive, RoHS Directive				
Compatible sensor head			HG-S1010-AC, HG-S1110-AC, HG-S1010(R), HG-S1110(R), HG-S1032, HG-S1050				
Number of connectable controllers			Up to 15 slave units can be connected per master unit. (Note 2)				
Supply voltage			24 V DC $\pm 10\%$, including ripple 0.5 V (P-P)				
Current consumption (Note 3)			70 mA or less (when sensor head is connected)				
Analog current output (Note 4)			<ul style="list-style-type: none"> Current output range: 4 to 20 mA/F.S. (default value) Error output: 0 mA Linearity: $\pm 0.25\%$ F.S. Load impedance: 250 Ω max. 		_____		
Control output (Output 1, Output 2, Output 3)		<NPN output type> NPN open-collector transistor <ul style="list-style-type: none"> Maximum sink current: 50 mA (Note 5) Applied voltage: 30 V DC or less (between output and 0 V) Residual voltage: 1.5 V or less (at 50 mA sink current) Leakage current: 0.1 mA or less 	<PNP output type> PNP open-collector transistor <ul style="list-style-type: none"> Maximum source current: 50 mA (Note 5) Applied voltage: 30 V DC or less (between output and +V) Residual voltage: 1.5 V or less (at 50 mA source current) Leakage current: 0.1 mA or less 	_____			
	Short-circuit protection	Incorporated (automatic reset type)				_____	
	Judgment output	NO / NC switching method				_____	
	Alarm output	Open when alarm occurs				_____	
External input (Input 1, Input 2, Input 3)		<NPN output type> Non-contact input or NPN open-collector transistor <ul style="list-style-type: none"> Input condition: Invalid (+8 V to +V DC or open) Valid (0 to +1.2 V DC) Input impedance: 10 kΩ approx. 	<PNP output type> Non-contact input or PNP open-collector transistor <ul style="list-style-type: none"> Input condition: Invalid (0 to +0.6 V DC or open) Valid (+4 V to +V DC) Input impedance: 10 kΩ approx. 	_____			
	Trigger input	Input time 2 ms or more (ON)				_____	
	Preset input	Input time 20 ms or more (ON)				_____	
	Reset input	Input time 20 ms or more (ON)				_____	
	Bank input A / B (Note 6)	Input time 20 ms or more (ON)				_____	
Response time			3 ms, 5 ms, 10 ms, 100 ms, 500 ms, 1,000 ms switching type				
Digital display			204-segment LCD				
Display resolution			0.1 μm 0.004 mil				
Display range			-199.9999 to 199.9999 mm -7.874 to 7.874 in				
Pollution degree			2				
Operating altitude			2,000 m 6561.68 ft or less (Note 7)				
Environmental resistance	Protection	IP40 (IEC)					
	Ambient temperature	-10 to +50 $^{\circ}\text{C}$ +14 to +122 $^{\circ}\text{F}$ (No condensation or icing) (Note 5), Storage: -20 to +60 $^{\circ}\text{C}$ -4 to +140 $^{\circ}\text{F}$					
	Ambient humidity	35 to 85 % RH, Storage: 35 to 85 % RH					
	Voltage withstandability	1,000 V AC for one min. between all supply terminals connected together and enclosure					
	Insulation resistance	20 M Ω , or more, with 250 V DC megger between all supply terminals connected together and enclosure					
	Vibration resistance	10 to 150 Hz frequency, 0.75 mm 0.030 in double amplitude (10 to 58Hz), maximum acceleration 49 m/s ² (58 to 150 Hz) in X, Y and Z directions for two hours each					
Shock resistance	98 m/s ² acceleration (10 G approx.) in X, Y and Z directions five times each						
Material			Case: Polycarbonate, Cover: Polycarbonate, Switches: Polyacetal				
Cable		0.2 mm ² 2-core cable (brown and blue lead wires) / 0.15 mm ² 7-core composite cable, 2 m 6.562 ft long	0.15 mm ² 7-core composite cable, 2 m 6.562 ft long	0.15 mm ² 6-core cabtyre cable, 2 m 6.562 ft long	_____		
Weight		Net weight: 140 g approx.	Net weight: 140 g approx.	Net weight: 130 g approx.	Net weight: 60 g approx.		

Notes: 1) Where measurement conditions have not been specified precisely, the conditions used were as follows: supply voltage 24 V DC, ambient temperature +20 $^{\circ}\text{C}$ +68 $^{\circ}\text{F}$.

2) When a digital displacement sensor communication unit is connected, a maximum of 14 slave units can be connected per master unit.

3) Current consumption does not include analog current output.

4) Linearity F.S. = 16 mA, and is linearity with respect to digitally measured values.

5) When slave units are connected to the master unit, the maximum sink current / source current of the control output and ambient temperature vary depending on the number of connected slave units as shown below.

Number of connected slave units	Maximum sink current / source current of control output	Ambient temperature
1 to 7 units	20 mA	-10 to +45 $^{\circ}\text{C}$ +14 to +113 $^{\circ}\text{F}$
8 to 15 units	10 mA	

6) Banks 1 to 3 can be selected by switching bank input A / B.

7) Do not use or store in an environment that has been pressurized to an air pressure higher than the atmospheric pressure at 0 m.

SPECIFICATIONS

Communication unit for digital displacement sensors

Designation	CC-Link IE Field communication unit	
Item	Model No.	
	SC-HG1-CEF	
Regulatory compliance	EMC Directive, RoHS Directive	
Compatible controllers	HG-SC□, HG-TC□	
Maximum number of connectable controllers	Maximum of 15 controllers (one master, 14 slaves) per SC-HG1-CEF unit	
Supply voltage (Note 2)	24 V DC ±10 %, including 0.5 V ripple (P-P)	
Current consumption	200 mA or less	
Communication method	CC-Link IE Field	
Remote station type	Remote device station	
Network No. setting	1 to 239 (decimal) [1 to EF (hex)] (0 and 240 or more: Error) (Note 3)	
Cyclic transmission (Maximum number of links per station)	RX/Ry: 128 points each (128 bits), 16 bytes, RW/r/RWw: 64 points each (64 words), 128 bytes	
Transient transmission	Server function only, data size 1024 bytes	
Station No. setting	1 to 120 (decimal) (0 and 121 or more: Error)	
Communication speed	1 Gbps	
Transmission line type	Line, star (mixing of line and star types is possible), ring	
Maximum transmission distance	100 m 328.084 ft	
Maximum number of units connectable	121 units (1 master station, 120 slave stations)	
Cascade connection levels	Maximum 20	
Pollution degree	2	
Operating altitude	2,000 m 6561.68 ft or less (Note 4)	
Environmental resistance	Protection	IP40 (IEC)
	Ambient temperature	-10 to +45°C +14 to +113 °F (No dew condensation or icing allowed), Storage: -20 to +60°C -4 to +140°F
	Ambient humidity	35 to 85 % RH, Storage: 35 to 85 % RH
	Voltage withstandability	1,000 V AC for one min. between all supply terminals connected together and enclosure
	Insulation resistance	20 MΩ or more, with 250 V DC megger between all supply terminals connected together and enclosure
	Vibration resistance	10 to 150 Hz frequency, 0.75 mm 0.030 in double amplitude (10 to 58Hz), maximum acceleration 49 m/s ² (58 to 150 Hz) in X, Y and Z directions for two hours each
	Shock resistance	98 m/s ² acceleration (10 G approx.) in X, Y and Z directions five times each
Material	Enclosure: Polycarbonate	
Communication cable	Ethernet cable that satisfies 1000BASE-T standard Category 5e or higher (Double-shielded / STP, straight cable) (Note 5)	
Weight	Net weight: 100 g approx., Gross weight: 150 g approx.	

- Notes: 1) Where measurement conditions have not been specified precisely, the conditions used were ambient temperature +20 °C **+68 °F**.
 2) Power is supplied from a connected controller / master controller.
 3) For the network number setting on this product, convert the network number to hex and set the hex value.
 4) Do not use or store in an environment that has been pressurized to an air pressure higher than the atmospheric pressure at 0 m.
 5) Use CC-Link Partner Association recommended cable.

Designation	CC-Link communication unit					
Item	Model No.	SC-HG1-C				
Regulatory compliance	EMC Directive (Note 2), RoHS Directive					
Compatible controllers	HG-SC□, HG-TC□					
Maximum number of connectable controllers	Maximum of 15 controllers (one master, 14 slaves) per SC-HG1-C unit					
Supply voltage (Note 3)	24 V DC ±10 %, including 0.5 V ripple (P-P)					
Current consumption	80 mA or less					
Communication method	Switchable CC-Link Ver.1.10 or 2.00					
Remote station type	Remote device station					
Number of occupied station	CC-Link Ver.1.10: 4 stations, CC-Link Ver.2.00: Switchable 2 or 4 stations					
Station No. setting	1 to 64 (0 and 65 or more: Error)					
Communication speed	10 Mbps	5 Mbps	2.5 Mbps	625 kbps	156 kbps	
Maximum transmission distance	100 m 328.084 ft	160 m 524.934 ft	400 m 1,312.336 ft	900 m 2,952.756 ft	1,200 m 3,937.008 ft	
Pollution degree	2					
Operating altitude	2,000 m 6561.68 ft or less (Note 4)					
Environmental resistance	Protection	IP40 (IEC)				
	Ambient temperature	-10 to +45°C +14 to +113 °F (No dew condensation or icing allowed), Storage: -20 to +60°C -4 to +140°F				
	Ambient humidity	35 to 85 % RH, Storage: 35 to 85 % RH				
	Voltage withstandability	1,000 V AC for one min. between all supply terminals connected together and enclosure				
Environmental resistance	Insulation resistance	20 MΩ or more, with 250 V DC megger between all supply terminals connected together and enclosure				
	Vibration resistance	10 to 150 Hz frequency, 0.75 mm 0.030 in double amplitude (10 to 58 Hz), maximum acceleration 49 m/s ² (58 to 150 Hz) in X, Y and Z directions for two hours each				
	Shock resistance	98 m/s ² acceleration (10 G approx.) in X, Y and Z directions five times each				
Material	Enclosure: Polycarbonate					
Communication cable	Specified cable (shielded twisted cable) (Note 5)					
Weight	Net weight: 80 g approx., Gross weight: 130 g approx.					

- Notes: 1) Where measurement conditions have not been specified precisely, the conditions used were ambient temperature +20 °C **+68 °F**.
 2) If our product will be incorporated in a customer product that will comply with the EMC Directive, install our product in a conductive box in accordance with "PLC User's Manual [Published by Mitsubishi Electric Corporation]".
 3) Power is supplied from a connected controller / master controller.
 4) Do not use or store in an environment that has been pressurized to an air pressure higher than the atmospheric pressure at 0 m.
 5) Use only a special-use communication cable that is approved by the CC-Link Partner Association.

SPECIFICATIONS

Designation		EtherCAT communication unit
Item	Model No.	SC-HG1-ETC
Regulatory compliance		EMC Directive, RoHS Directive
Compatible controllers		HG-SC□, HG-TC□
Maximum number of connectable controllers		Maximum of 15 controllers (one master, 14 slaves) per SC-HG1-ETC unit
Supply voltage (Note 2)		24 V DC ±10 %, including ripple 0.5 V (P-P)
Current consumption		100 mA or less
Communication protocol		EtherCAT
Compliance		IEEE 802.3u (100BASE-TX)
Communication speed		100 Mbps (100BASE-TX)
Communication connector		RJ-45 × 2
Node-to-node distance		100 m 328.084 ft or less
Supported functions		Process data object communication (cyclic communication) Mailbox communication (message communication) CoE Explicit Device Identification Station Alias
Pollution degree		2
Operating altitude (Note 3)		2,000 m 6,561.68 ft or less
Environmental resistance	Ambient temperature	-10 to +45 °C +14 to +113 °F (No dew condensation or icing allowed), Storage: -20 to +60 °C -4 to +140 °F
	Ambient humidity	35 to 85 % RH, Storage: 35 to 85 % RH
	Voltage withstandability	1,000 V AC for one min. between all supply terminals connected together and enclosure
	Insulation resistance	20 MΩ or higher, using 250 V DC megger between all supply terminals connected together and enclosure
	Vibration resistance	10 to 150 Hz frequency, 0.75 mm 0.030 in double amplitude (10 to 58Hz), maximum acceleration 49 m/s ² (58 to 150 Hz) in X, Y and Z directions for two hours each
	Shock resistance	98 m/s ² (10 G approx.) acceleration in X, Y, and Z directions five times each
Grounding method		Casing: Floating type
Material		Enclosure: Polycarbonate
Communication cable		Category 5e (shielded twisted pair cable recommended)
Weight		Net weight: 90 g approx., Gross weight: 150 g approx.

- Notes: 1) Where measurement conditions have not been specified precisely, the conditions used were an ambient temperature of +20 °C **+68 °F**.
 2) Power is supplied from a connected controller / master controller.
 3) Do not use or store in an environment that has been pressurized to an air pressure higher than the atmospheric pressure at 0 m.

Designation		RS-485 communication unit
Item	Model No.	SC-HG1-485
Regulatory compliance		EMC Directive, RoHS Directive
Compatible controllers		HG-SC□, HG-TC□
Supply voltage (Note 2)		24 V DC ±10 %, Ripple (P-P) 10 % or less (Within specified power supply voltage range)
Current consumption		40 mA or less
Communication method		Two-wire half duplex communication
Synchronization method		Start-stop synchronization
Communication protocol		MODBUS (RTU / ASCII) / MEWTOCOL-COM
Communication speed		1.2 kbps / 2.4 kbps / 4.8 kbps / 9.6 kbps / 19.2 kbps / 38.4 kbps / 57.6 kbps / 115.2 kbps
Electrical characteristics		Complies with EIA RS-485
Number of connectable units	Host (RS-485)	1 to 99 units when MODBUS (RTU / ASCII) is used, 1 to 64 units when MEWTOCOL-COM is used
	Controllers	Maximum of 15 controllers (one master, 14 slaves) per SC-HG1-485 unit
Stop bit length		1 bit / 2 bits
Parity check		Even / Odd / None
Data bit length		8 bits (RTU) / 7 bits (ASCII)
Pollution degree		2
Operating altitude		2,000 m 6561.68 ft or less (Note 3)
Environmental resistance	Protection	IP40 (IEC)
	Ambient temperature	-10 to +45 °C +14 to +113 °F (No dew condensation or icing allowed), Storage: -20 to +60 °C -4 to +140 °F
	Ambient humidity	35 to 85 % RH, Storage: 35 to 85 % RH
	Voltage withstandability	1,000 V AC for one min. between all supply terminals connected together and enclosure
	Insulation resistance	20 MΩ or more, with 250 V DC megger between all supply terminals connected together and enclosure
	Vibration resistance	10 to 150 Hz frequency, 0.75 mm 0.030 in double amplitude (10 to 58Hz), maximum acceleration 49 m/s ² (58 to 150 Hz) in X, Y and Z directions for two hours each
	Shock resistance	98 m/s ² acceleration (10 G approx.) in X, Y and Z directions five times each
Material		Enclosure: Polycarbonate
Total extension distance		Communication cable: 1,200 m 3,937.008 ft or less between SC-HG1-485 (terminal) and PLC
Weight		Net weight: 75 g approx., Gross weight: 120 g approx.
Accessories		Termination resistor switching jumper pin: 1 pc.

- Notes: 1) Where measurement conditions have not been specified precisely, the conditions used were ambient temperature +20 °C **+68 °F**.
 2) Power is supplied from a connected controller / master controller.
 3) Do not use or store in an environment that has been pressurized to an air pressure higher than the atmospheric pressure at 0 m.

NPN output type

HG-SC101 / Master unit

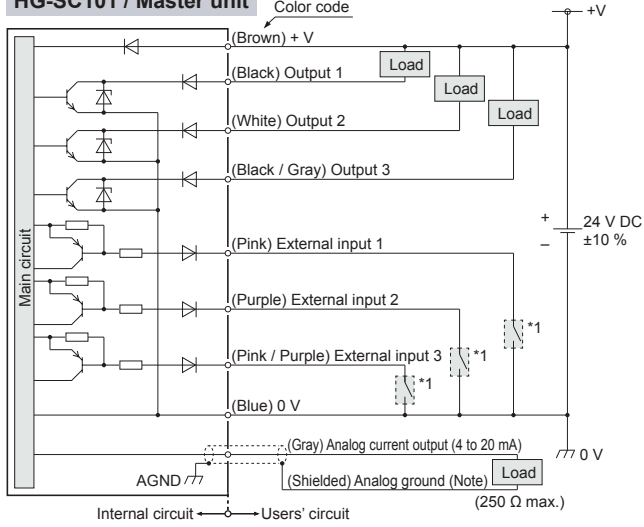

PNP output type

HG-SC101-P / Master unit

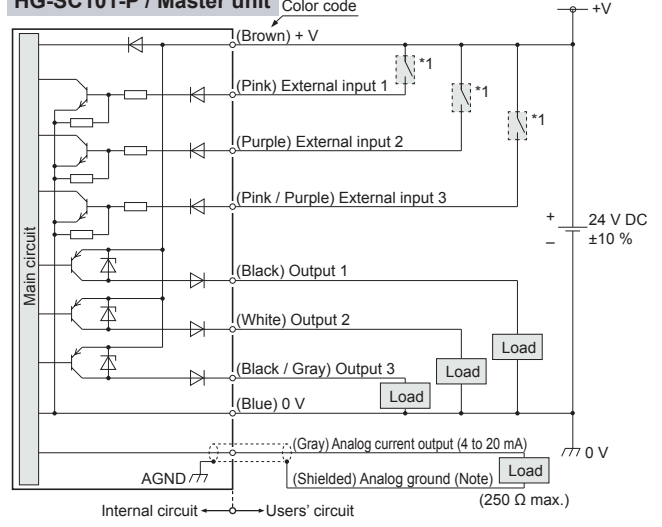

HG-SC111 / Slave unit

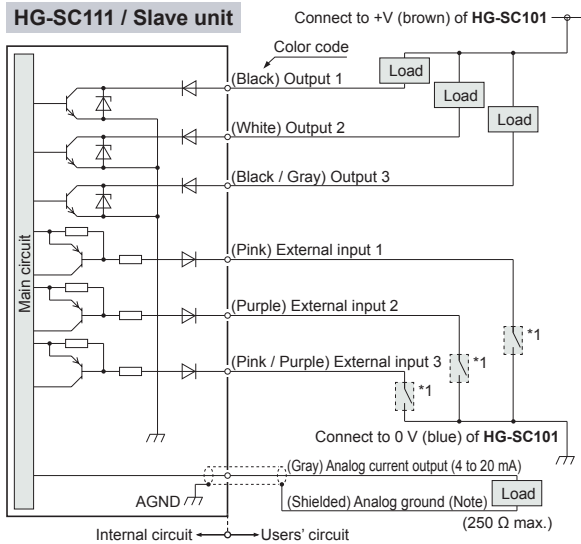

HG-SC111-P / Slave unit

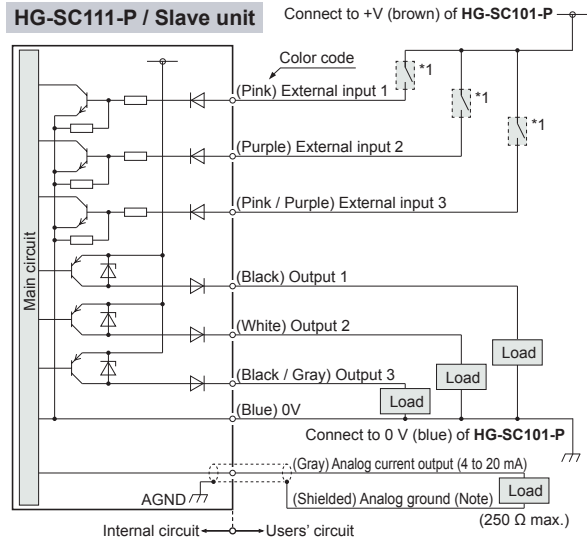

HG-SC112 / Slave unit

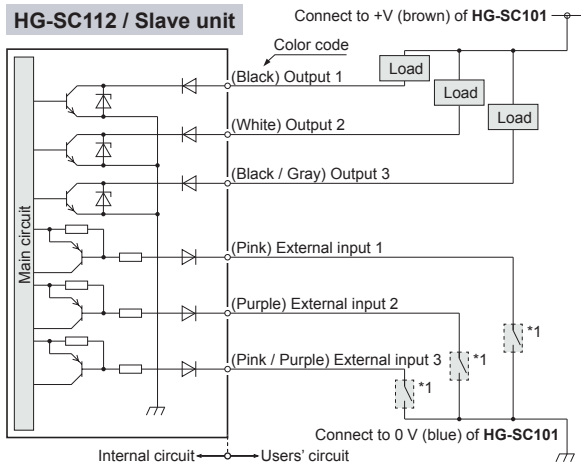

HG-SC112-P / Slave unit

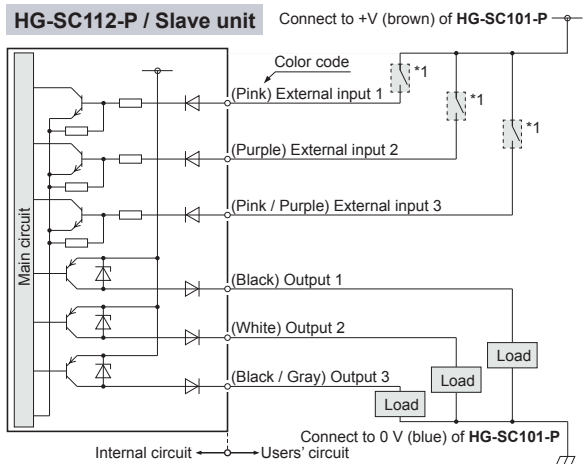

*1

Non-voltage contact or NPN open collector transistor

0 to +1.2 V DC: Effective
+8 V to +V DC or open: Ineffective

*1

Non-voltage contact or PNP open collector transistor

+4 V to +V DC: Effective
0 to +0.6 V DC or open: Ineffective

Note: Use shielded wire for the analog output.

Note: Use shielded wire for the analog output.

AIR CIRCUIT (RECOMMENDED)

For details, refer to the User's Manual.
The User's Manual can be downloaded from our website.

- When using air-driven type sensor heads (HG-S1010-AC / HG-S1110-AC), configure an air circuit similar to the one shown in the diagram below, and adjust the spindle speed using the speed control valve as needed.

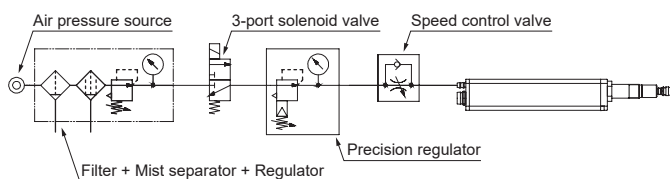

- Notes:
- 1) Supply clean air (free from moisture, oil, dust, or other foreign objects) to this product.
 - 2) Air pressure may decrease, depending on the length of the air pipe from the air supply source or any pneumatic components (such as needle valves, speed controllers, or mini-filters) that are added. Take care to ensure that air pressure supply to the product is sufficient. Select pneumatic components suitable for the supplied air pressure.
 - 3) The 3-port solenoid valve and speed control valve have their respective mounting directions. Mount each valve in their correct direction by referring to the diagram on the left.
 - 4) A filter with a rated filtration of 5 μm 0.197 mil or less and a mist separator with a rated filtration of 0.3 μm 0.012 mil or less are recommended.

PRECAUTIONS FOR PROPER USE

For details, refer to the User's Manual.
The User's Manual can be downloaded from our website.



- Never use this product as a sensing device for personnel protection.
- When using sensing devices for personnel protection, use products that meet the laws and standards for personnel protection that apply in each region or country, such as OSHA, ANSI and IEC.

- This catalog is a guide to select a suitable product. Be sure to read instruction manual attached to the product prior to its use.

Part description

Sensor head

**Air-driven type
(HG-S1010-AC /
HG-S1110-AC)**

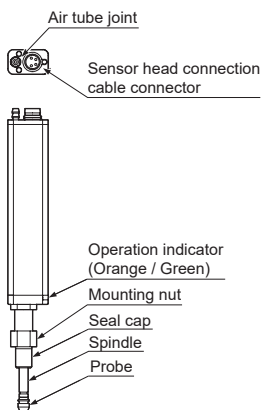

**Regular type • Standard
(HG-S1010 / HG-S1110)**

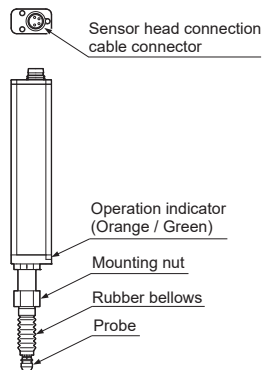

**Regular type •
Low measuring force
(HG-S1010R / HG-S1110R)**

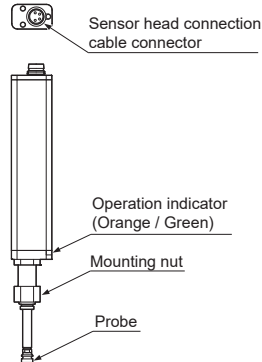

**Regular type • Standard
(HG-S1032)**

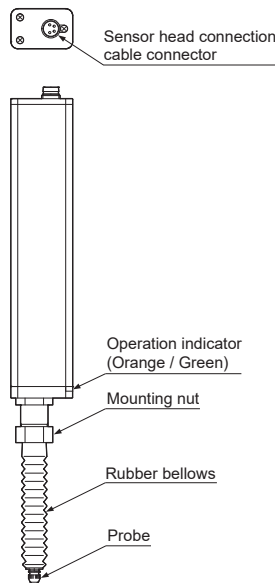

**Regular type • Standard
(HG-S1050)**

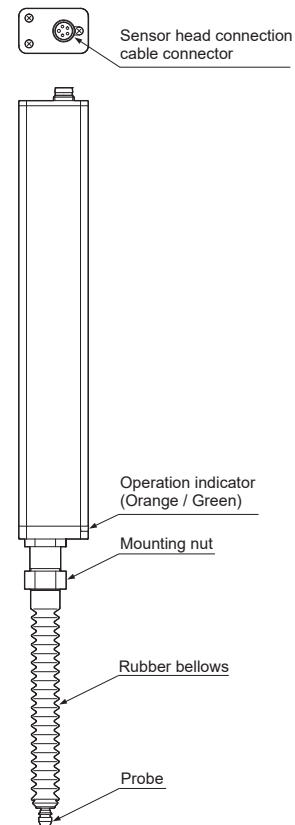

Controller

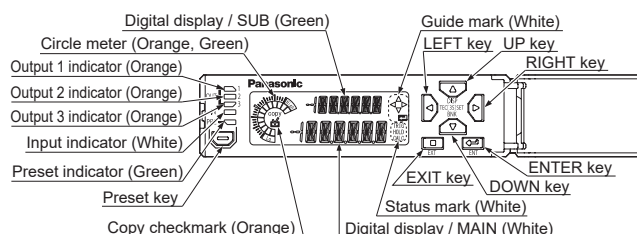
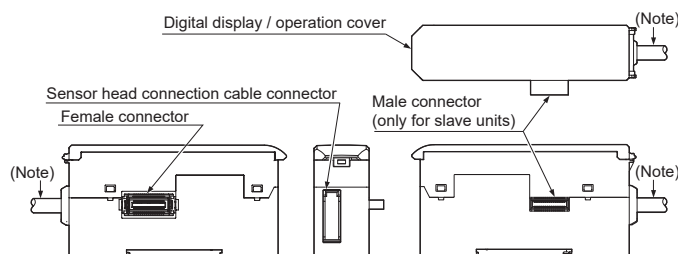

Note: Not provided on slave units, wire-saving type (HG-SC113).

PRECAUTIONS FOR PROPER USE

For details, refer to the User's Manual.
The User's Manual can be downloaded from our website.

Sensor head

Mounting

- Mount the sensor unit perpendicular to the measured surface. Mounting the sensor unit obliquely may not only result in measurement error but also significantly shorten its service life.
- When tightening the nut, take care not to damage the rubber bellows.
- If the rubber bellows is deformed, a load will occur when the spindle operates and damage may result.
- Do not remove the rubber bellows from the standard type products (**HG-S1010 / HG-S1110 / HG-S1032 / HG-S1050**) except for when replacing them. Unnecessary removal of rubber bellows can result in entry of dust and water, thus causing malfunction.

1. Open a hole in the housing in which the sensor head will be mounted.

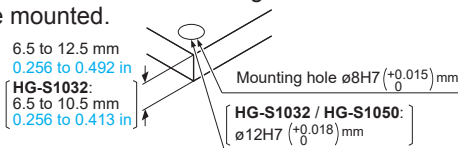

2. Insert the sensor head into the hole you opened in the housing, and fasten provisionally with the provided mounting nut.

Note: The orientation of the mounting nut depends on the thickness of the housing. For details, refer to DIMENSIONS (p.27 and 28).

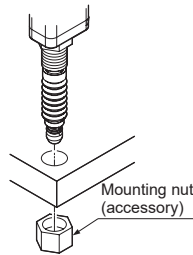

3. Fasten the sensor head. When fastening the sensor head, tighten the mounting nut with a wrench while holding the sensor head in place with the provided sensor head fastening wrench as shown right. Tighten to a torque of 12.5 N·m or less (**HG-S1032 / HG-S1050:** 15 N·m or less).

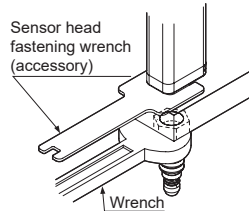

4. Make sure that the rubber bellows has not become deformed as shown right. If the rubber bellows is deformed, restore the normal shape by rotating the bellows or otherwise.

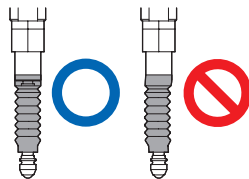

Attaching the sensor head connection cable

- Sensor head connection cable with L-shape connector **CN-HS-C□L** (optional) cannot be used with an air-driven type sensor head.
- When disconnecting, always make sure that the fastening ring has been completely loosened before pulling out the cable.
- Risk of damage if you pull the cable with excessive force (15 N or more) with the fastening ring tightened.

Mounting

1. Insert the sensor head connection cable into the connector for the sensor head connection cable on the sensor head.
2. Turn the fastening ring on the sensor head connector in the direction shown to fasten the ring.

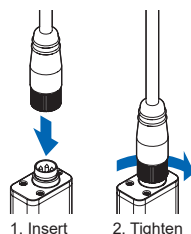

Removal method

1. Turn the fastening ring on the sensor head connector in the direction of the arrow to loosen the ring.
2. Grasp the sensor head connector and pull up to remove.

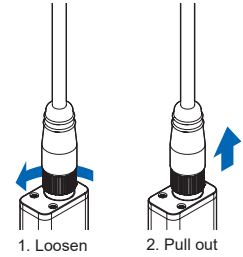

Connecting the air tube (For air-driven type only)

- When connecting the air tube, firmly secure it with the air tube clamp provided. If the air tube is used without inserting or securing it properly, there is a danger that the air tube may come off.

How to connect

1. While loosening the air tube clamp, slide it from the tip of the air tube and then release it when it reaches halfway through the tube.
2. Insert the tip of the air tube until it reaches the root of the joint on the sensor head.
3. Move the air tube clamp and secure the tip of the air tube.

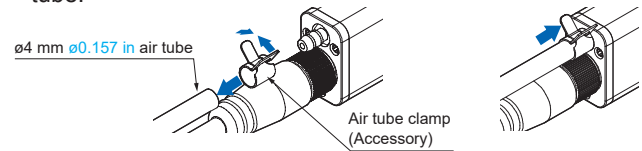

How to disconnect

1. While loosening the air tube clamp, move it halfway through the air tube.
2. Grasp the sensor head and pull out the air tube.

Note: Take care not to lose the air tube clamp.

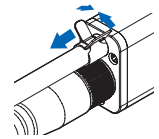

How to replace the seal cap (For air-driven type only)

- Before detaching or reattaching the seal cap, be sure to stop the air supply and disconnect it from the unit.
- To prevent problems, replace the seal cap before the internal O-ring becomes worn.

- Replace the seal cap at appropriate intervals according to the deterioration status of the sealing material. Replace the seal cap when the number of sliding operations reaches approximately five million.

How to remove

1. Remove the probe.
2. While pulling the seal cap, expose the edge of the O-ring.
3. Loosen the seal cap by rotating it in the direction indicated by the arrow.
4. After loosening the seal cap completely, pull it out.
5. Finally, remove the O-ring.

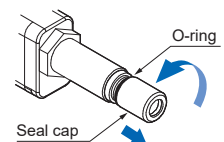

How to mount

1. Mount the O-ring in the specified position.
2. Slide the seal cap onto the spindle and move it to a position where it can rotate at no load.
3. Push in the seal cap while rotating it in the direction indicated by the arrow.

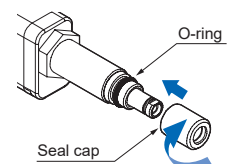

Note: Check that the O-ring does not protrude.

PRECAUTIONS FOR PROPER USE

Controller

Mounting

Mounting

1. Insert the rear of the mounting part into the DIN rail.
2. While pressing down on the rear of the mounting part, insert the front of the mounting part into the DIN rail.

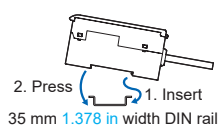

Removal method

1. Grasp the product and push forward.
2. Lift the front to remove.



Attaching the sensor head connection cable

Mounting

1. Insert the sensor head connection cable into the connector for the sensor head connection cable on the controller.

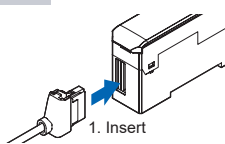

Removal method

1. Grasp the controller, and while pressing on the lock release lever on the connector of the sensor head connection cable, pull toward you to disconnect.

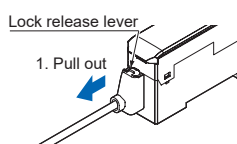

Note: If you attempt to disconnect the cable by pulling it without pressing the lock release lever, cable wire breakage and connector damage may occur.

How to identify newer and older controllers, and combinations with sensor heads

- **HG-S1050** and air-driven type sensor heads must be used in combination with **HG-SC** controllers manufactured in or after February 2019.

- If the **HG-SC** controller is used together with the **HG-TC** controller for thru-beam type digital displacement sensor **HG-T** series, make sure to use the **HG-SC** controller manufactured in or after February, 2019. Furthermore, connect the slaves units of the same series to the side closer to the master unit and the slave units of the other series to the far side.
- When connecting only **HG-S** series controllers, both newer and older controllers can be connected.

How to identify newer controllers (manufactured in or after February 2019)

- Indication on the side of main unit

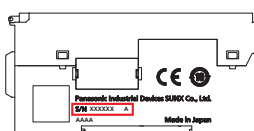

"A" at the end of serial No.

Combinations with sensor heads

Combination		Newer controller	Older controller
		Manufactured in or after February 2019	Manufactured in or before January 2019
Sensor head	HG-S1010(R)	Possible	Possible
	HG-S1110(R)		
	HG-S1032		
	HG-S1050		
Air-driven type	HG-S1010-AC	Possible	Not possible
	HG-S1110-AC		

Connection

- Always shut off the power before connecting a slave unit to or disconnecting a slave unit from the master unit. Risk of controller damage if you attempt connection with the power on.
- Insert the male connector firmly into the female connector. Risk of controller damage if not completely connected.
- To connect units, the units must be mounted on a DIN rail. Attach end plates **MS-DIN-E** (optional) so as to enclose the connected units at the ends.
- Up to 15 slave units (up to 14 slave units when a communication unit for digital displacement sensor is connected) can be connected per master unit.
- When connecting slave units to a master unit, connect only NPN output types, or only PNP output types. Dissimilar output types cannot be connected together.

Connection method

1. Mount one master unit on the DIN rail.
2. Remove the connector cover.
3. Mount each slave unit one at a time on the DIN rail. Remove all connector covers except for the cover on the end slave unit.
4. Slide each slave unit to connect the female and male connectors.
5. Attach end plates **MS-DIN-E** (optional) with the flat side facing in so as to enclose the connected units at the ends.
6. Tighten the screws to fasten the end plates.

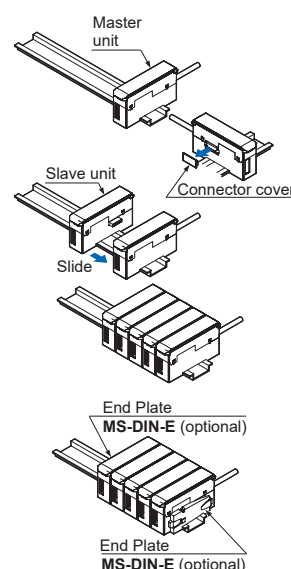

Removal method

1. Loosen the screws on the end plates
2. Remove the end plates.
3. Slide and remove the controllers, one at a time.

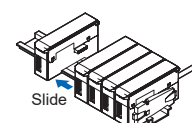

Common

Wiring

- The product is designed to fulfill the specifications when combined with the **HG-S** sensor head and **HG-SC** controller. If the product is used in combination with other products, it not only fails to meet the specifications but also generates a malfunction in some cases.
 - For the controller DC power supply, only use a power supply that is isolated by means of an isolation transformer or otherwise.
 - Risk of short-circuiting and damage to the controller or power supply if a transformer such as an auto transformer is used. Risk of short-circuiting and damage to the controller or power supply if incorrectly mounted or connected.
- Make sure that the power supply is OFF while performing wiring or expansion work.
 - After you have completed wiring work, check the wiring carefully before switching on the power.
 - Do not wire in parallel with a high-voltage line or power line, or run through the same conduit. Risk malfunctioning due to induction.
 - Verify that the supply voltage fluctuations are within the rating.
 - If power is supplied from a commercial switching regulator, ensure that the frame ground (F.G.) terminal of the power supply is connected to an actual ground.
 - Do not apply stress such as excessive bending or pulling to the extracted part of a cable.

Others

- This device has been developed / produced for industrial use only.
- Do not use this product outside the range of the specifications. Risk of an accident and product damage. There is also a risk of a noticeable reduction of service life.
- Do not use during the initial transient time after the power supply is switched ON.
- This controller uses an EEPROM. The EEPROM has a service life of one million setting operations.
- This product is suitable for indoor use only.
- Avoid dust, dirt, and steam.
- Do not use the product in an environment containing corrosive gases or ozone.
- Ensure that the product does not come into contact with organic solvents such as thinner.
- Ensure that the product does not come into contact with strong acid or alkaline.
- Ensure that the product does not come into contact with oil or grease.
- This product cannot be used in an environment containing flammable or explosive gases.
- Performance may not be satisfactory in a strong electromagnetic field.
- This product is a precision device. Do not drop or otherwise subject to shock. Risk of product damage.
- Mount the sensor unit perpendicular to the measured surface. Mounting the sensor unit obliquely may not only result in measurement error but also significantly shorten its service life.
- Do not allow excessive horizontal force to be applied to the spindle. This may cause reduced accuracy and durability.
- If the product is an air-driven type, install a pressure-reducing valve to use the product within the allowable working pressure range. Excessive pressure may result in failure or damage.
- If the product is an air-driven type, do not use air containing foreign objects (such as dust), water, or oil. Doing so may result in electric shock or failure. To prevent such problems, take appropriate measures such as mounting air filters or mist separators.
- If the product is an air-driven type, before performing maintenance, inspection, or cleaning, always shut off air supply completely and check that the pressure inside the product and piping is zero. Failure to do so may result in accidents or failures due to air pressure.
- Never attempt to disassemble, repair, or modify the product.

DIMENSIONS (Unit: mm in)

The CAD data can be downloaded from our website.

HG-S1010-AC HG-S1110-AC

Sensor head (Air-driven type)

Installation of sensor head connection cable

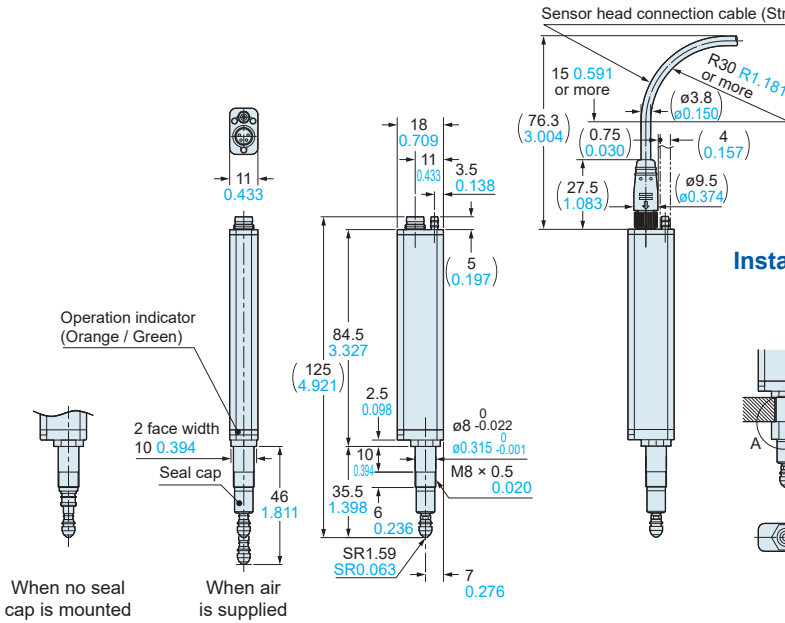

Installation of mounting nut attachment

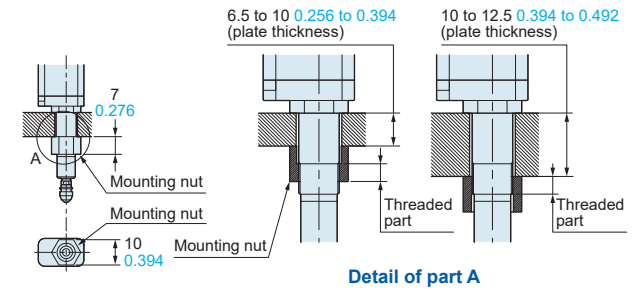

HG-S1010(R) HG-S1110(R)

Sensor head (Regular type)

Standard HG-S1010 / HG-S1110

Low measuring force HG-S1010R / HG-S1110R

Installation of sensor head connection cable

The diagrams show the sensor head connection cable connected to the low measurement force type.

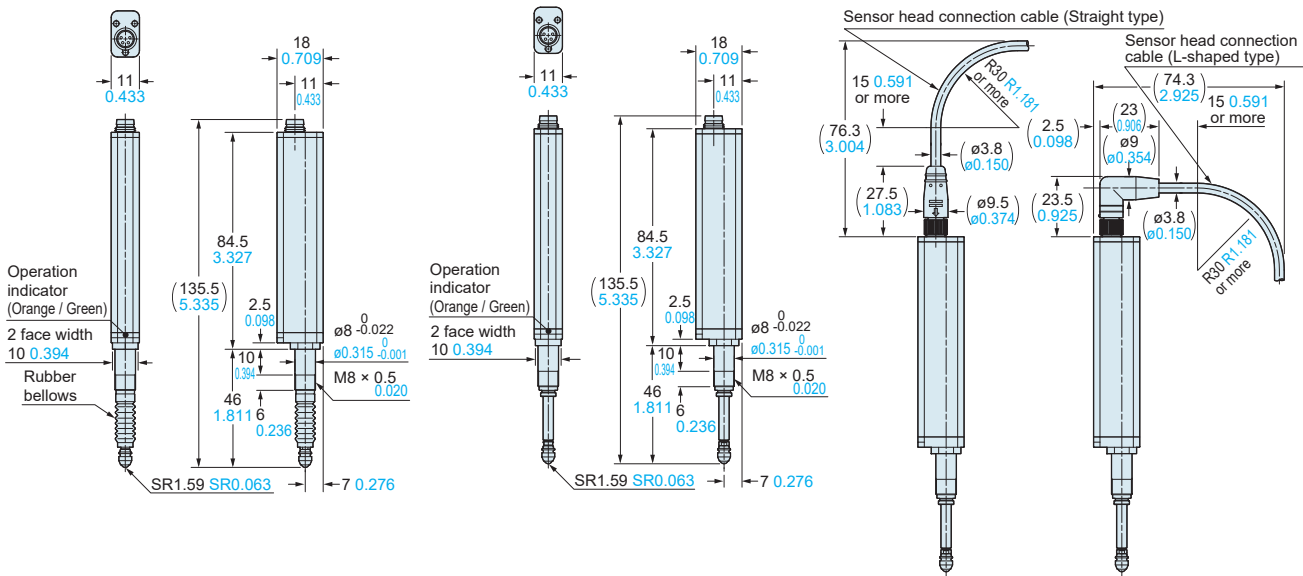

Installation of mounting nut attachment

Standard HG-S1010 / HG-S1110

Low measuring force HG-S1010R / HG-S1110R

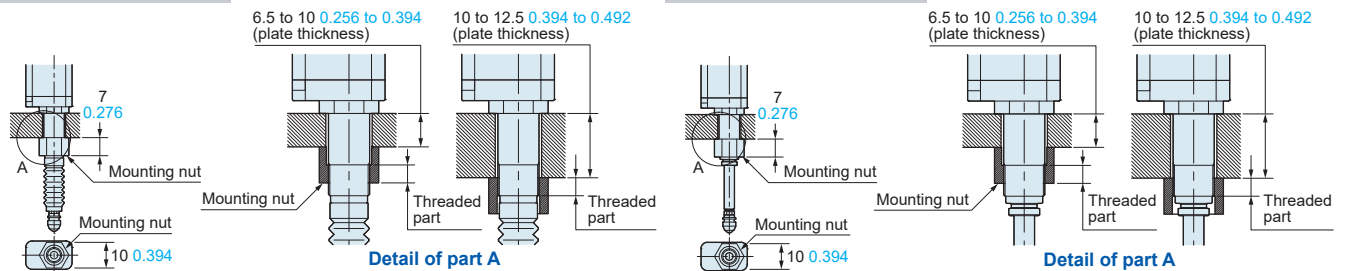

HG-S1032

Sensor head (Regular type)

Installation of mounting nut attachment

Installation of sensor head connection cable

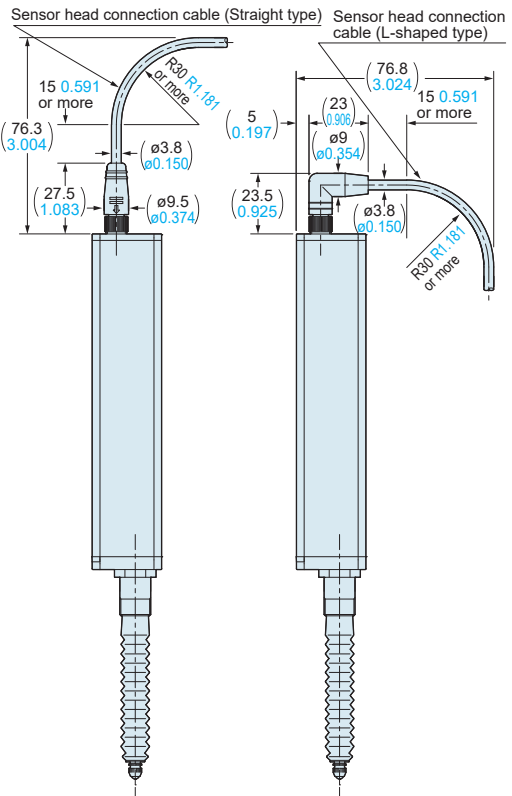
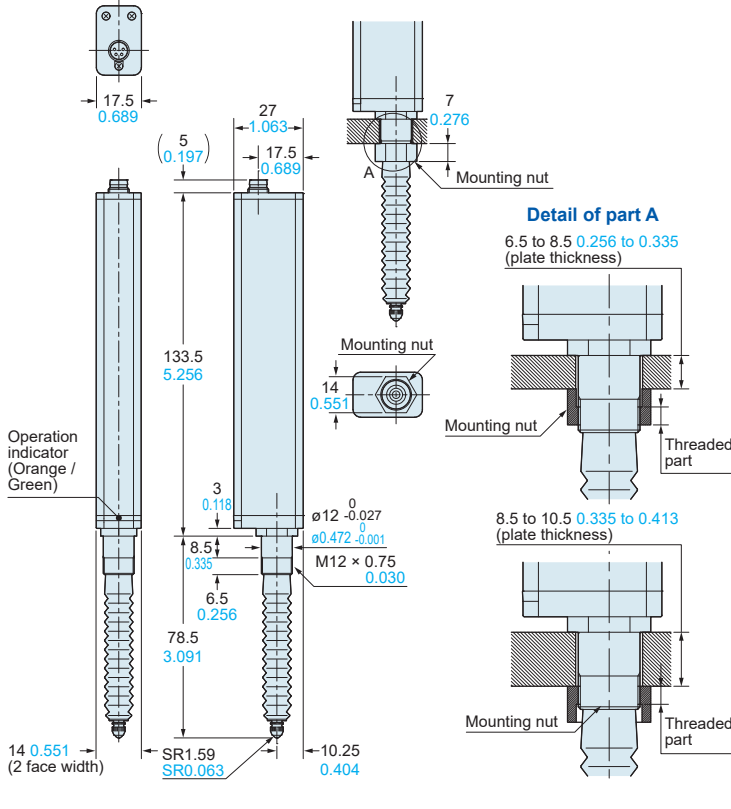

HG-S1050

Sensor head (Regular type)

Installation of mounting nut attachment

Installation of sensor head connection cable

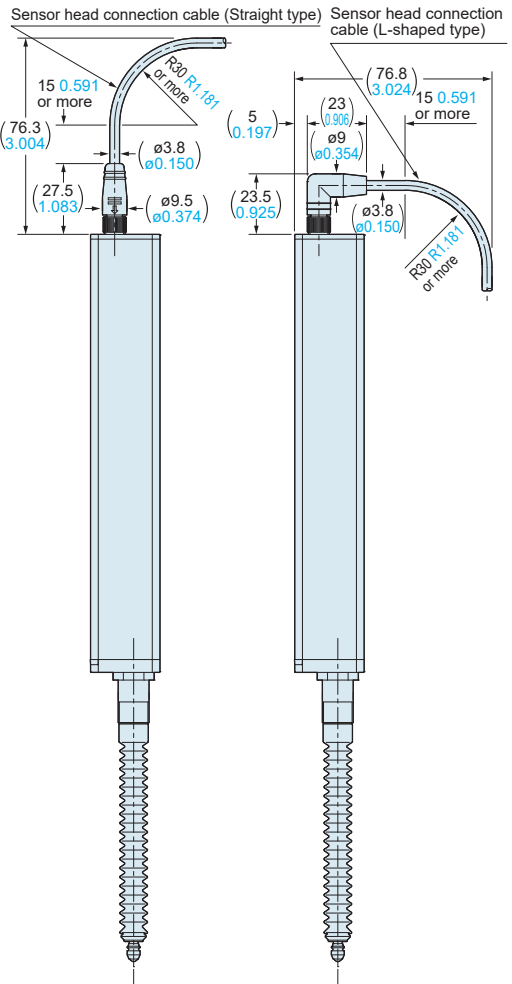
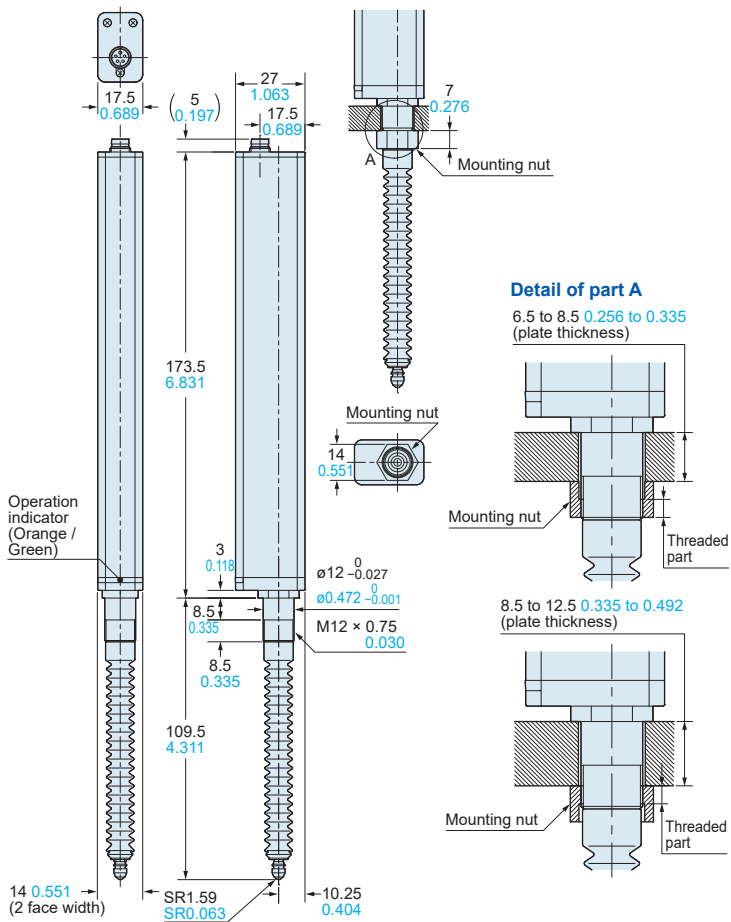

DIMENSIONS (Unit: mm in)

The CAD data can be downloaded from our website.

HG-SC101(-P)

Controller (Master unit)

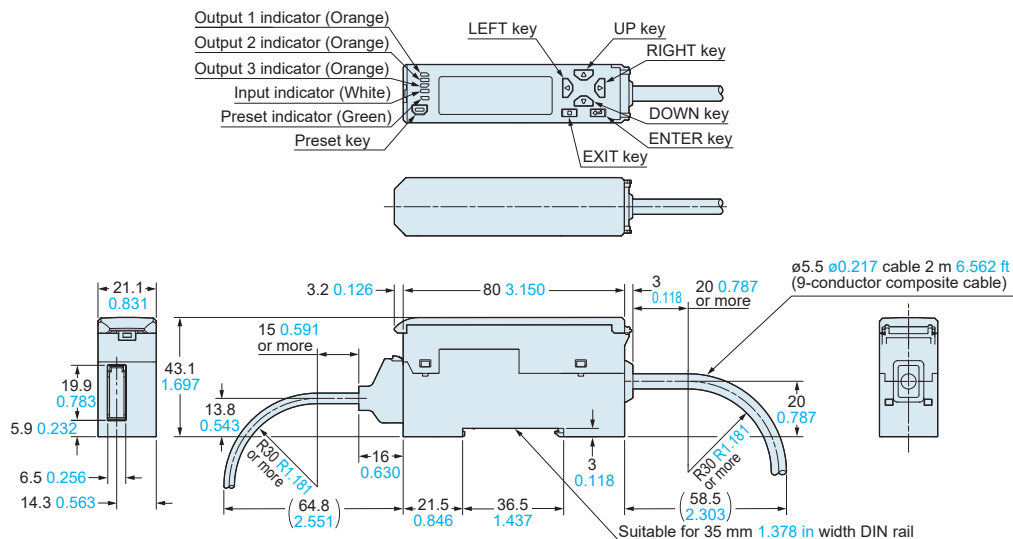

HG-SC111(-P) HG-SC112(-P)

Controller (Slave unit)

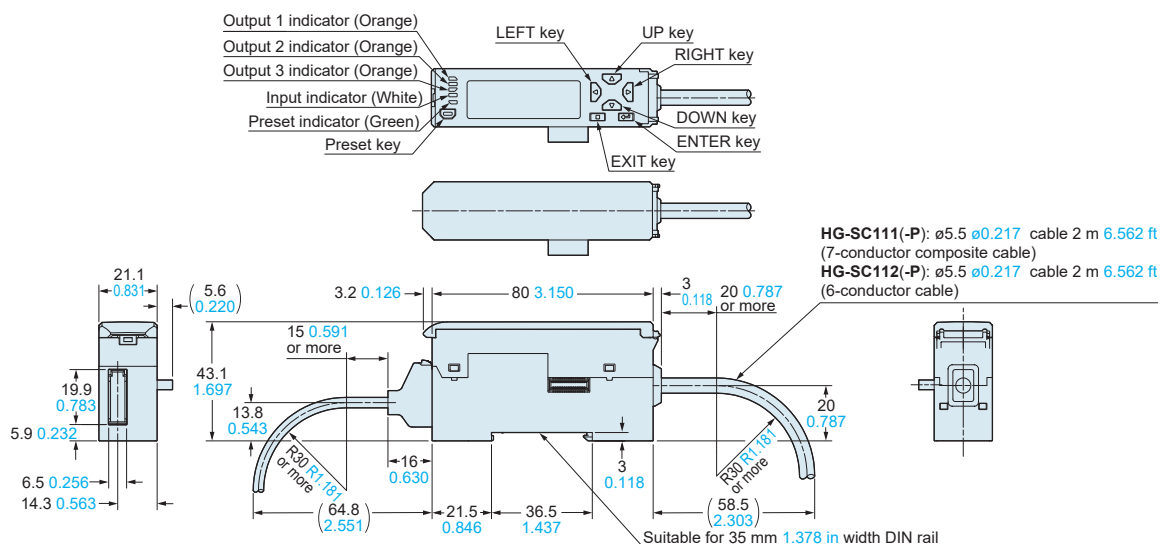

HG-SC113

Controller (Slave unit)

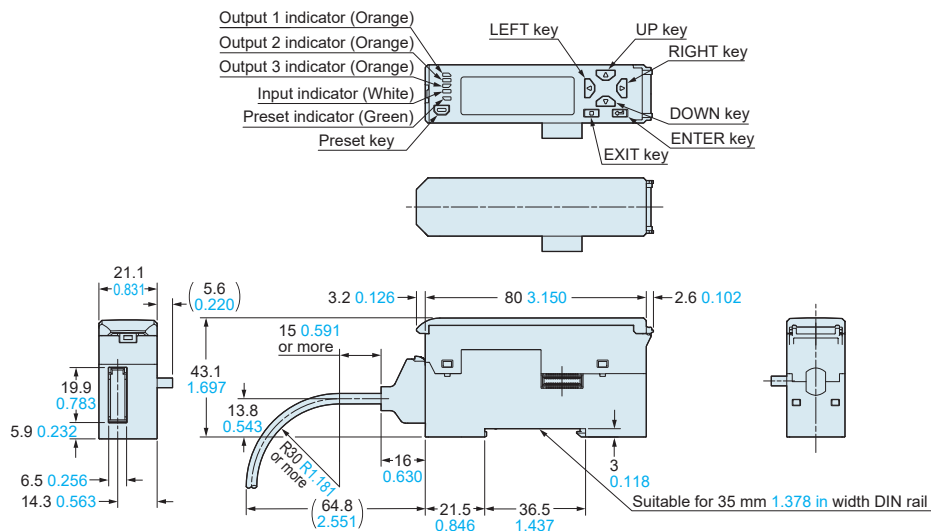

SC-HG1-CEF CC-Link IE Field communication unit

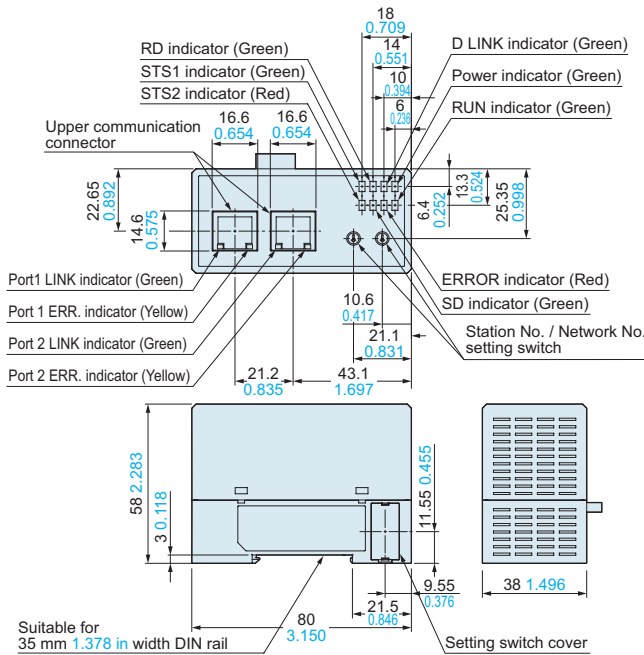

SC-HG1-C CC-Link communication unit

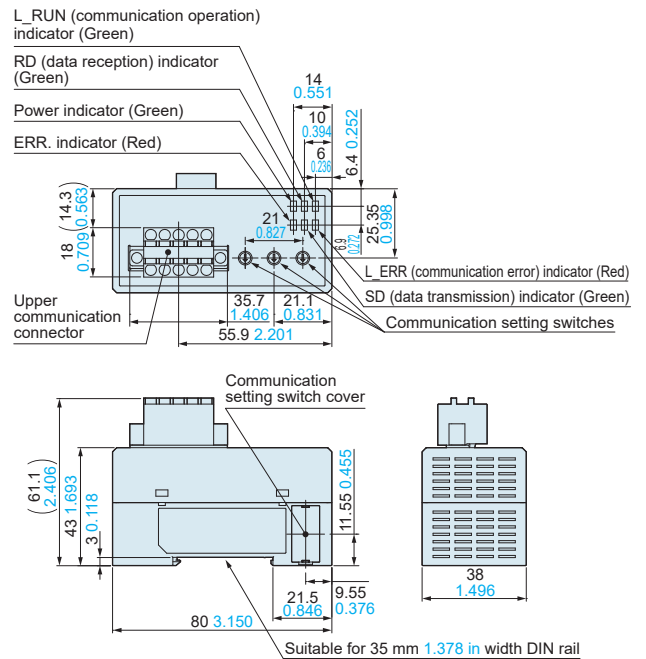

SC-HG1-ETC EtherCAT communication unit

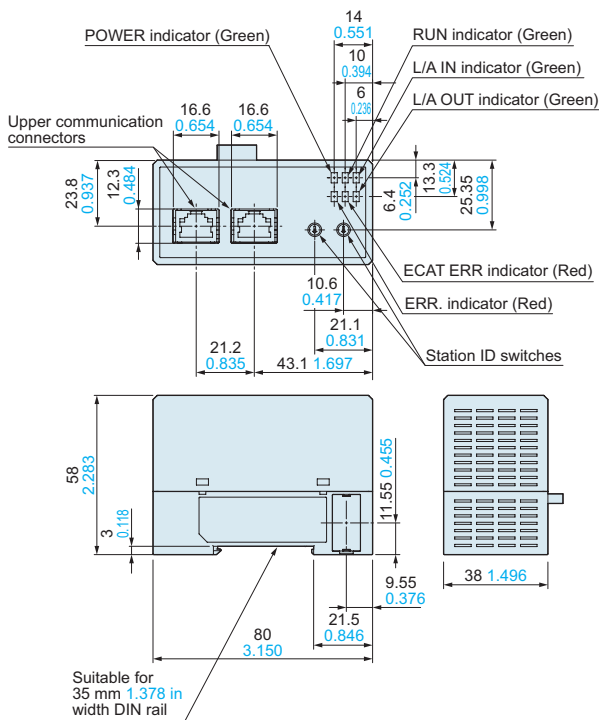

SC-HG1-485 RS-485 communication unit

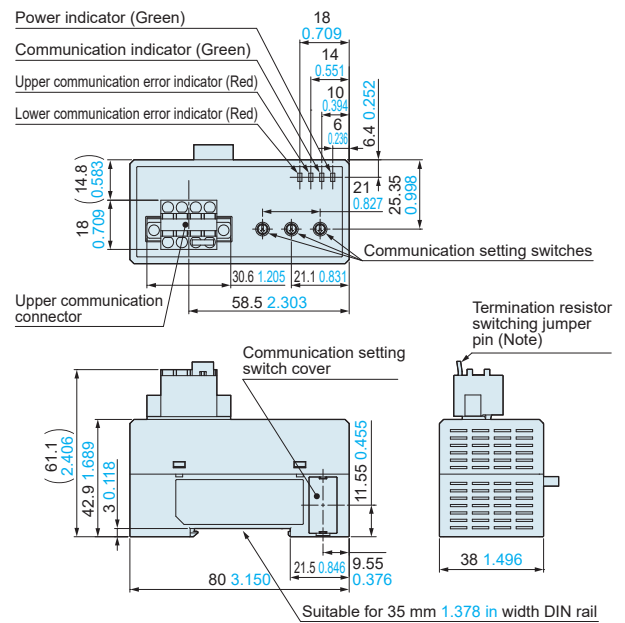

Note: The termination resistor switching jumper pin is not attached to the product at the factory. Attach the termination resistor switching jumper pin to the unit at the terminating end. Make sure that the termination resistor switching jumper pins have been removed from all units except the one at the terminating end.

MS-DIN-E End plate

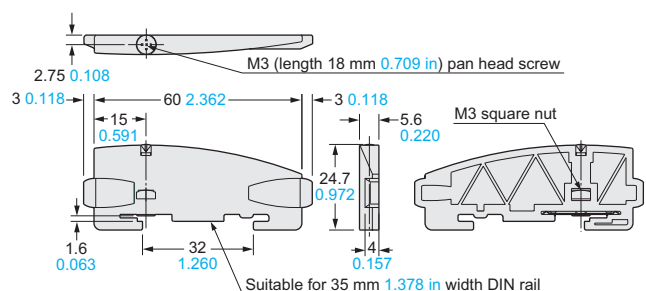

Material: Polycarbonate

DIMENSIONS (Unit: mm in)

The CAD data can be downloaded from our website.

HG-SS10C(×5) Probe (mounted on sensor head, a set of 5 (optional))

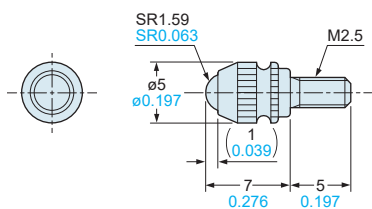

Material: Brass (body), ceramic (ball)

HG-SS10H Probe (optional)

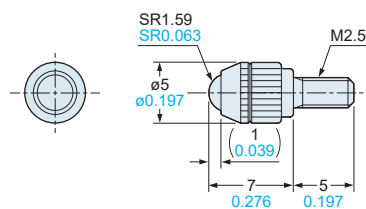

Material: Brass (body), carbide (ball)

HG-SS20H Probe (optional)

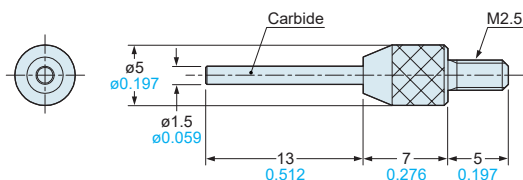

Material: Stainless steel (SUS) (body), carbide (needle)

HG-SS30S Probe (optional)

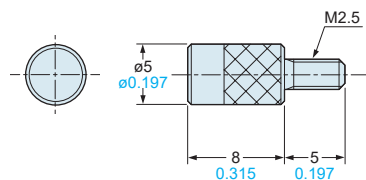

Material: Hardened steel

HG-SS40U Probe (optional)

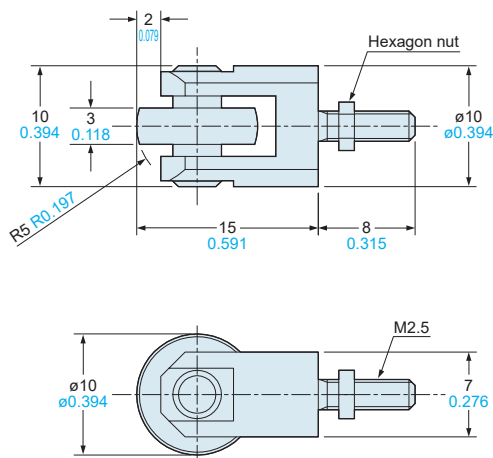

* Roller runout: 0.01 mm 0.393 mil or less
Material: Brass (body, nut), hardened steel (roller, shaft)

HG-SJ15 HG-SJ25 Joint (optional)

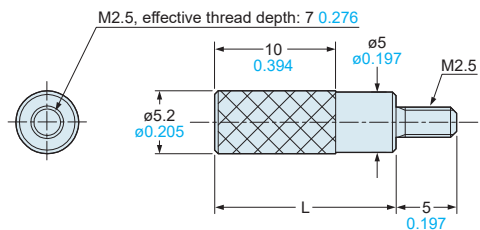

Material: Stainless steel (SUS)

Model	L
HG-SJ15	15 0.591
HG-SJ25	25 0.984

Thru-beam type digital displacement sensor

Thru-beam type digital displacement sensor
HG-T series

CMOS Type

Self-Monitoring Sensor

CE

FDA

The industry's highest-class^{*1} measurement accuracy is now yours.

Sensor head

Ultra-slim

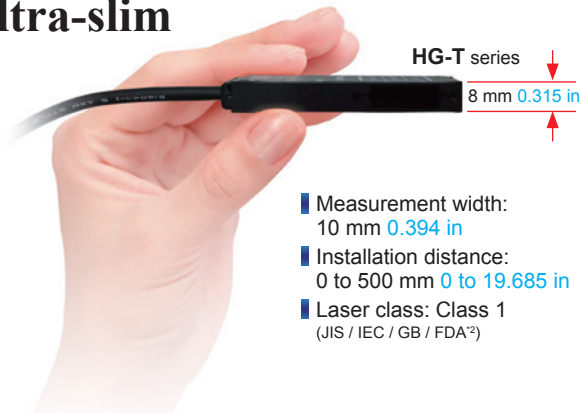

- Measurement width: 10 mm 0.394 in
- Installation distance: 0 to 500 mm 0 to 19.685 in
- Laser class: Class 1 (JIS / IEC / GB / FDA²)

■ The belt-shaped laser beam with a measurement width of 10 mm 0.394 in is used for measurement of dimensions and positions.

■ The HG-T series boasts repeatability³ of 1 μm 0.039 mil⁴ and offers the highest^{*1} measurement accuracy in the industry.

*1: As a thru-beam type sensor. As of January 2021, in-company survey.

*2: Conformance with 21 CFR 1040.10 and 1040.11 Laser Notice No. 50, dated June 24, 2007, issued by CDRH (Center for Devices and Radiological Health) under the FDA (Food and Drug Administration).

*3: This is the P-P value of digital measurement value with half shading at the middle position of the installation distance.

*4: When installation distance is 20 mm 0.787 in

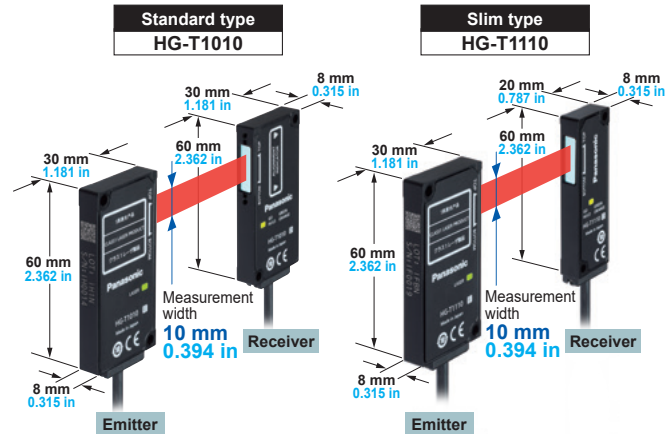

- Two types of sensor heads are available.
- Side view attachment is available (optional). [for HG-T1010]
- Beam axis adjustment assist function for easy setup of emitter and receiver
- Automatic emitter / receiver cable recognition for simplified connector connection
- Lightweight and robust die-cast aluminum case
- Protection structure IP67 (IEC)

Controller

High-performance

- Dual display for added indication flexibility (equipped with NAVI function)
- All-direction LCD
- Equipped with intuitive circle meter

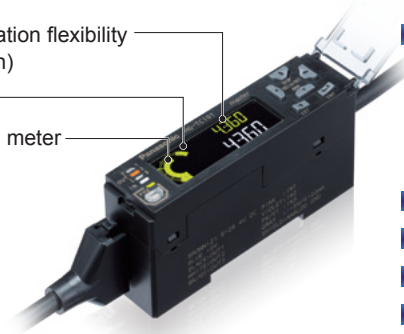

- Six types of detection modes
 - (1) Auto edge detection mode
 - (2) User assigned edge detection mode
 - (3) Edge detection mode
 - (4) Inside diameter / gap detection mode
 - (5) Outer diameter / width detection mode
 - (6) Central position detection mode
- Monitoring of effects caused by stains
- Stable measurement of even transparent workpieces
- Elimination of effects caused by fine foreign matters
- Disable abrupt measurement changes
- Equipped with 5 arithmetic functions
 - (1) Maximum value
 - (2) Minimum value
 - (3) Average value
 - (4) Reference value
 - (5) Thickness / width
- Connectable to contact-type digital displacement sensor HG-S series

Please contact

Panasonic Corporation

Industrial Device Business Division
 ■ 7-1-1, Morofuku, Daito-shi, Osaka 574-0044, Japan
industrial.panasonic.com/ac/e/

Panasonic[®]

©Panasonic Corporation 2021