



AS1

AREAscan™ high-resolution detection photoelectric light grids

- Crossed beam area sensors
- 100mm controlled height
- Adjustment trimmer
- Optical or wire synchronism
- Scan Mode input

APPLICATIONS

- Processing lines
- Food, Cosmetic and Pharmaceutical
- Electronics and mechanical assembling
- Conveyor lines and sorting systems



SENSORS



AS1		
Area sensing	100 mm	
Operating Distance	0,3...2,1 m (AS1-LD) 0,8...3 m (AS1-HD)	
Resolution	Flat: 0,2x75mm Cylindrical: Ø 6mm (AS1-HR) Flat: 0,2x200mm Cylindrical: Ø18mm (AS1-SR)	
Response Time	1,75 ms (AS1-SR) 2,75...8 ms (AS1-HR)	
Light emission	IR LED	
Power supply	Vdc	24 V
	Vac	
	Vac/dc	
Output	PNP	▪
	NPN	
	NPN/PNP	
	relay	
	other	
Connection	cable	
	connector	▪
	pig-tail	
Approximate dimensions (mm)	22x43x150	
Housing material	aluminium	
Mechanical protection	IP65	

Area Sensors - AS1



TECHNICAL DATA	
Power supply	24 Vdc \pm 15%
Consumption on emitter unit (TX)	150 mA max.
Consumption on receiver unit (RX)	40 mA max. load excluded
Light emission	IR LED 880 nm
Setting	adjustment trimmer (mod. AS1...P)
Indicators	yellow OUTPUT LED green POWER ON LED
Output	PNP
Output current	100 mA max.
Saturation voltage	1,5 V max.
Response time	2,75 - 8 ms (mod. AS1-HR) 1,75 ms (mod. AS1-SR)
Connection	M12 4-pole connector (TX), M12 5-pole connector (RX)
Dielectric strength	500 Vac, 1 min between electronics and housing
Insulating resistance	>20 M Ω , 500 Vdc between electronics and housing
Mechanical protection	IP65 (EN 60529)
Vibrations	0,5 mm amplitude, 10 ... 55 Hz frequency, for every axis (EN60068-2-6)
Shock resistance	11 ms (30 G) 6 shock for every axis (EN60068-2-27)
Housing material	black electro-painted aluminium
Lens material	PMMA
Operating temperature	0 ... 50 °C
Storage temperature	-25 ... 70 °C
Weight	300 g

DIMENSIONS

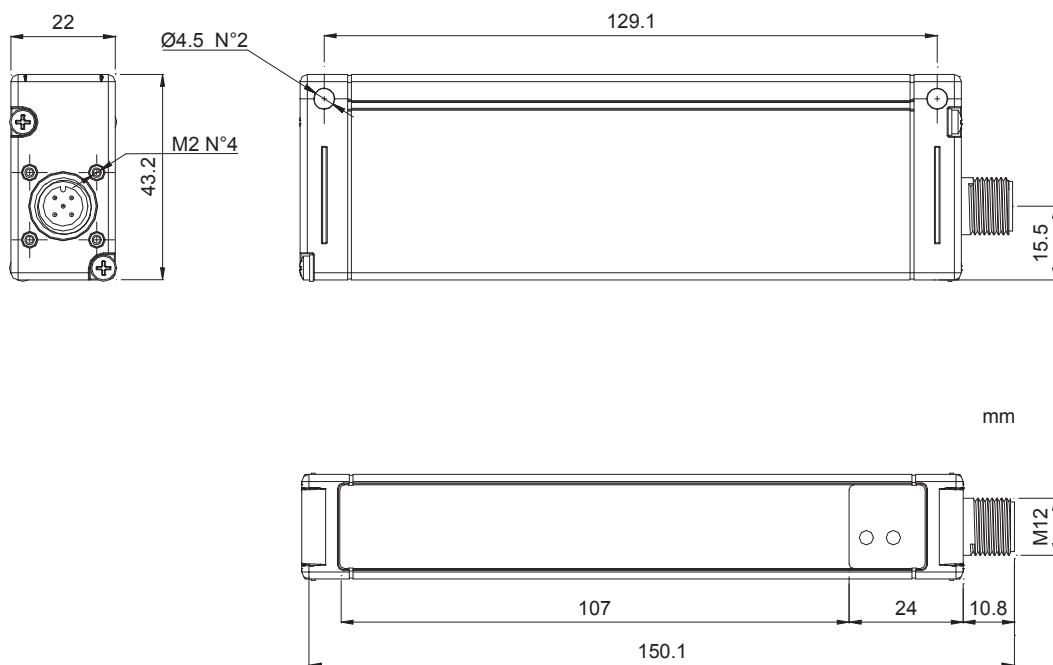

Area Sensors - AS1



INDICATORS AND SETTINGS

Two different models are available: high resolution (AS1-HR) or standard resolution (AS1-SR). In the first case the light array has 16 beams, while in the second case the beams are reduced to 6. In the AS1-HR model, the selection inputs of the SCAN MODE, can configure 4 different crossed-beam scanning modes. These different modes allow to vary the detection performances, in particular the resolution can be increased to 0.2mm thickness, or the response time up to less than 3ms.

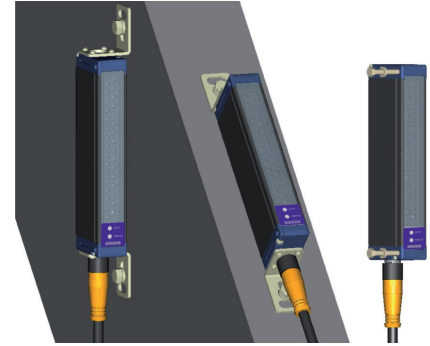

INDICATORS AND SETTINGS (TRIMMER VERSIONS)

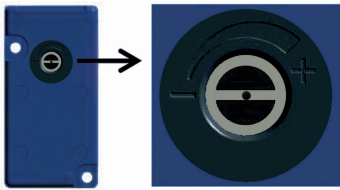

Emitter is equipped with a manual regulation which lets the user change the emission power by means of a screwdriver.

The emission power reduction can be particularly useful to lower passive reflections when maximum operating distance it is not required.

CONNECTIONS

M12 CONNECTOR

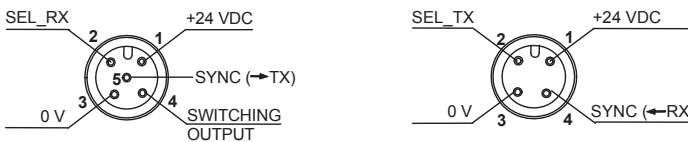

	AS1-HR	AS1-SR		AS1-HR	AS1-SR	
RECEIVER (RX): M12 5-pole connector	1 – brown:	+24 VDC	EMITTER (TX): M12 4-pole connector	1 – brown:	+24 VDC	
	2 – white:	SEL_RX		2 – white:	SEL_TX	Not used
	3 – blue:	0 V		3 – blue:	0 V	0 V
	4 – black:	Switching output		4 – black:	SYNC **	SYNC *
	5 – grey:	SYNC *				

* not used in trimmer version
** SEL_TX2 in trimmer version

HIGH RESOLUTION SCANNING MODE

PROG. N°	SEL_RX	SEL_TX	RESOLUTION	RESPONSE TIME (msec)
1	0 Vdc or FLOAT	0 Vdc or FLOAT	LOW	2.75
2	0 Vdc or FLOAT	24 Vdc	M/L	3
3	24 Vdc	0Vdc or FLOAT	M/H	7.75
4	24 Vdc	24 Vdc	HIGH	8

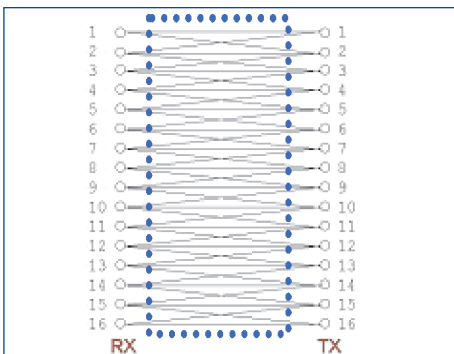

Scan mode 1:
high speed / low resolution
Minimum object detection
Flat = 0.4 (thickness) x 100 (width) mm
Cylindrical objects = Ø 6 mm

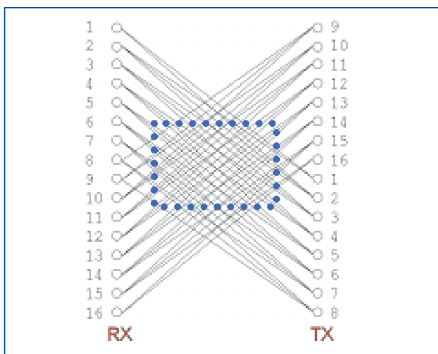

Scan mode 2:
high speed / mid resol. central area
Minimum object detection
Flat = 0.4 (thickness) x 90 (width) mm
Cylindrical objects = Ø 6 mm

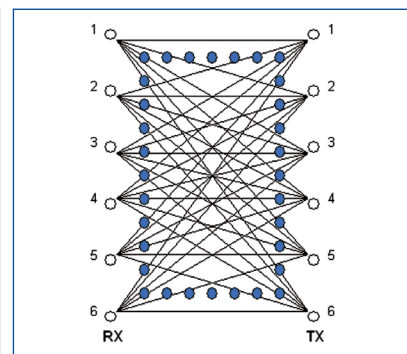

Scan mode 3-4:
low speed / high resolution
Minimum object detection
Flat = 0.2 (thickness) x 75 (width) mm
Cylindrical objects = Ø 6 mm

Area Sensors - AS1



STANDARD RESOLUTION SCANNING MODE

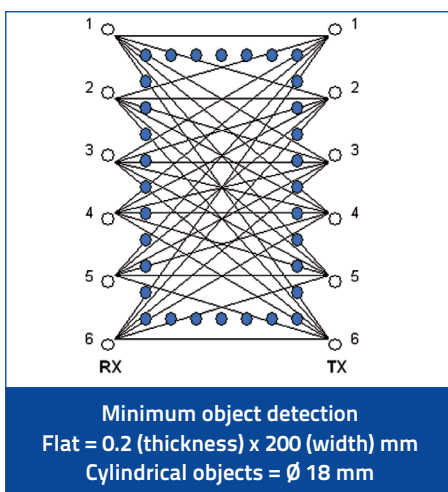

Note: the scan mode is fixed in the standard resolution version.

MODEL SELECTION AND ORDER INFORMATION

OPTIC FUNCTION	OPERATING DISTANCE	RESOLUTION	SETTING	MODEL	ORDER No.
Area sensor	2 m	High	n/a	AS1-LD-HR-010-J	958101000
			Adjustment Trimmer	AS1-LD-HR-010-P	958101040
		Standard	n/a	AS1-LD-SR-010-J	958101010
			Adjustment Trimmer	AS1-LD-SR-010-P	958101050
	3 m	High	n/a	AS1-HD-HR-010-J	958101020
		Standard		AS1-HD-SR-010-J	958101030

CABLES

TYPE	DESCRIPTION	LENGTH	MODEL	ORDER No.
Axial M12 Connector	4-pole, grey, P.V.C.	3 m	CS-A1-02-G-03	95A251380
		5 m	CS-A1-02-G-05	95A251270
		10 m	CS-A1-02-G-10	95A251390
	4-pole, U.L., black, P.V.C.	3 m	CS-A1-02-U-03	95ASE1120
		5 m	CS-A1-02-U-05	95ASE1130
		10 m	CS-A1-02-U-10	95ASE1140
		15 m	CS-A1-02-U-15	95ASE1150
		25 m	CS-A1-02-U-25	95ASE1160
		5-pole, grey, P.V.C.	3 m	CS-A1-03-G-03
	5-pole, U.L., black, P.V.C	5 m	CS-A1-03-G-05	95ACC2120
		10 m	CS-A1-03-G-10	95ACC2140
		3 m	CS-A1-03-U-03	95ASE1170
		5 m	CS-A1-03-U-05	95ASE1180
		10 m	CS-A1-03-U-10	95ASE1190
		15 m	CS-A1-03-U-15	95ASE1200
		25 m	CS-A1-03-U-25	95ASE1210
		50 m	CS-A1-03-U-50	95A252700