

Panasonic

INDUSTRY

DIGITAL FIBER SENSOR

FX-500 SERIES Ver.2
 FX-550 SERIES
 FX-550L SERIES

IO-Link Compatible,
 Self-Monitoring Type



At the industry's leading edge

FX-SERIES HIGH END MODEL



FX-501 / FX-502

Direct connection to open network communication units

CC-Link IE Field
 SC-GU3-04

CC-Link
 SC-GU3-01 / SC-GU2-C

DeviceNet
 SC-GU3-02

EtherCAT
 SC-GU3-03

Stability

Industry leading stability

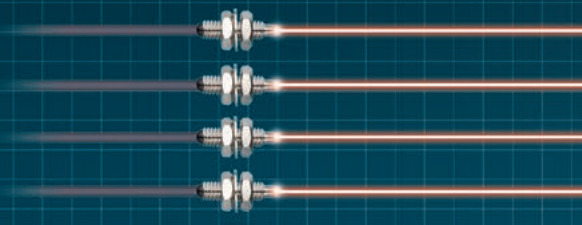

High stability!

We aim for absolute digitalization, focusing on the variation among fiber sensors. When the FX-500 series is used together with our super quality fiber, the incident light intensity variation among units is decreased to only 1/4 of that of conventional models. Changes in detection that could not be found in the past can now be monitored.

Super quality fiber

+

FX-500 series

Threshold value Incident light intensity

Previous amplifier

	Threshold value	Incident light intensity
①	350	755
②	700	1386
③	500	987
④	800	1593

Management of different threshold values for each sensor is required.

1/4

incident light intensity variation
[compared to previous model]

Digital control is essentially achieved

Stability of the incident light intensity is improved by 4 times*. Values of incident light intensity stay close together even after replacing an amplifier.

* Using a small diameter fiber (fiber core $\phi 0.5$ mm $\phi 0.020$ in). If using a standard fiber (fiber core $\phi 1.0$ mm $\phi 0.039$ in), the variation will be double of that of conventional models.

Incident light intensities are stable.

Management of just one threshold value.

Just one threshold value for all sensors

If multiple fiber sensors are installed in the same operating conditions, the incident light intensities are nearly identical. With the new sensor version, one exact threshold value can be managed across all sensors.

Easy maintenance with stable fiber sensors

Because the incident light intensity is stable, the same threshold value can be used even when an amplifier is replaced. Also, the optical communication makes copying easier.

Confidence in beam adjustment

Stabilizing incident light intensity helps to raise installation precision and to make beam alignment fast and trouble-free.

Improved fiber coupling efficiency and suppressed variation among units

In each unit we have accurately aligned the central axis of the fiber with the central axis of the emitted light, which creates a high coupling efficiency that helps to reduce variation among units.

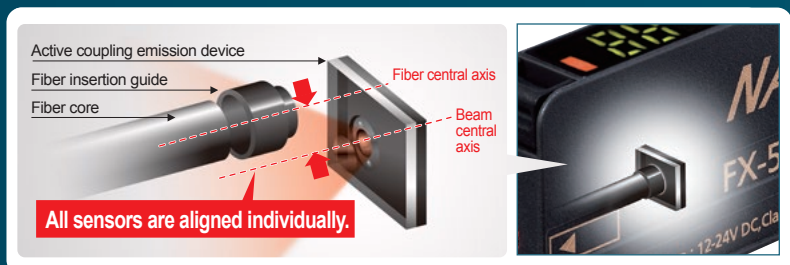

* Image

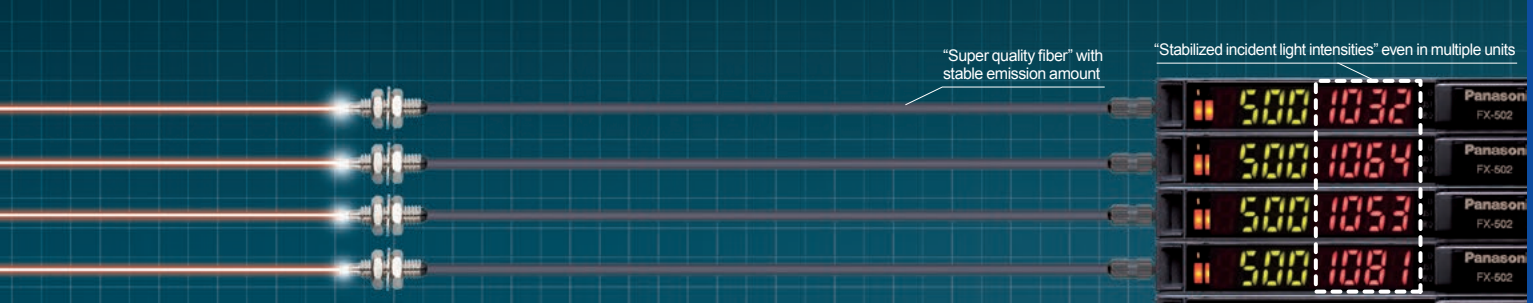

"Stabilized incident light intensities" even in multiple units

A quality that surpassed that of standard fibers Introducing the super quality fiber

New fibers developed using a new manufacturing method adopted by our own factory along with a persistent quality control system

The basic performance of a standard fiber is greatly enhanced!

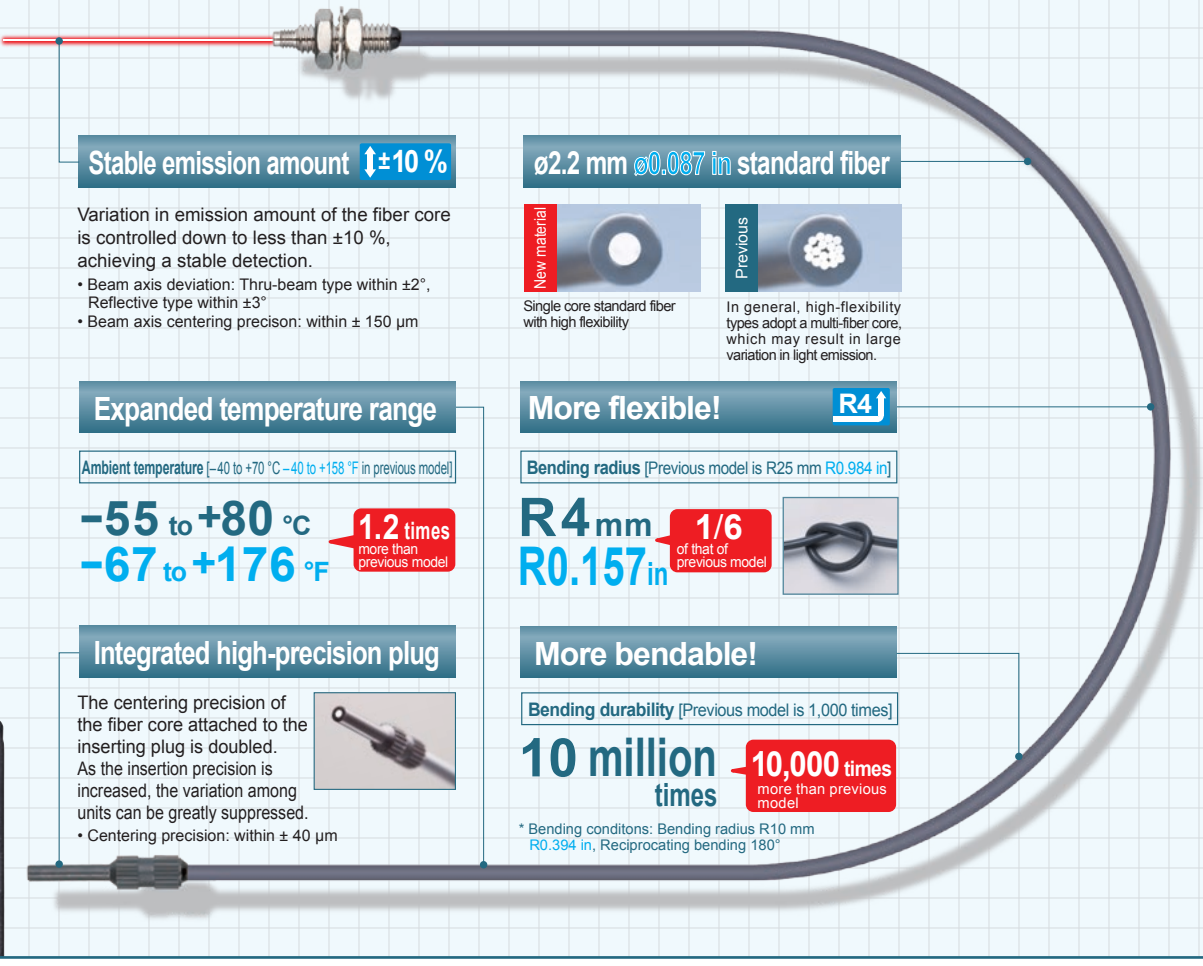

$\updownarrow \pm 10\%$

Variation in emission intensity is down to less than $\pm 10\%$

Under our new manufacturing method and quality control system, we have developed fiber heads that have a stabilized light emission. When used with the FX-500 amplifier, a complete digital control is essentially achieved.

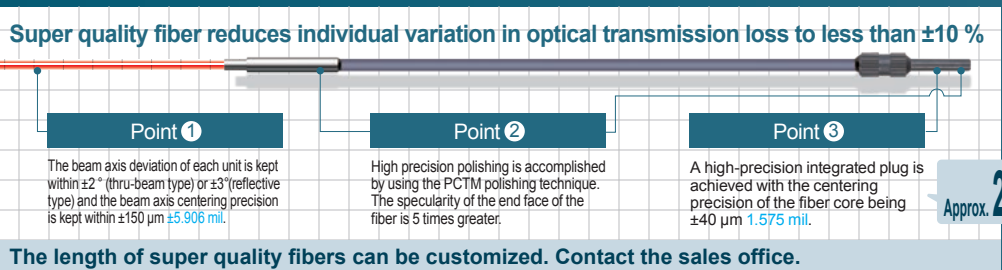

Speed & Distance

Industry leading sensing performance

High-speed response & Ultra long range detection

The exclusive detection IC combined with the high-intensity beam emitted from the active coupling emission device provides the capability of offering high-speed response time over a longer sensing range, opening up new possibilities for fiber sensor detection.

Max. 25 μ s response time

FX-500 with its high response time contributes to improve productivity.

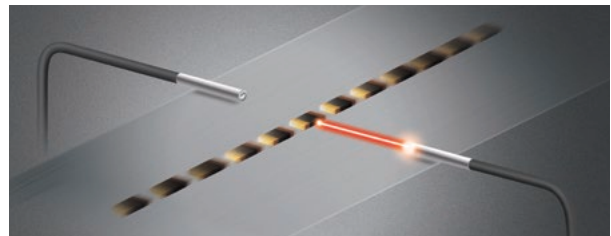

Performing minute object detection when using a small diameter fiber is now possible with a high response time and longer sensing range.

Hyper HYPR mode incorporated

FX-500 in combination with small diameter fibers which can handle challenging detections, allows long sensing range.

Max. 5.7 times!
longer than the previous model

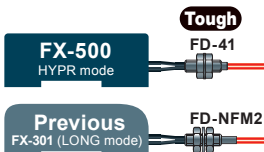

Note: When using FD-NFM2.

Detecting minute objects

Small diameter fibers can perform detection in long range and with stability even for minute objects.

High-speed mode

A high speed response time of 25 μ s, which is 2.6 times faster than the previous model, as well as a long sensing range are both achieved in high-speed mode.

The active coupling emission device efficiently focuses the beam through small diameter fibers

The super fine optical lens and emitting element are combined into one device enabling the beam emitted from the emitting element to be focused directly into the fiber. Coupling efficiency is therefore increased by 50 % compared to standard fiber (core \varnothing 1 mm \varnothing 0.039 in). In particular, the small diameter fibers (core \varnothing 0.5 mm \varnothing 0.020 in) see a dramatic increase in light intensity, making challenging detections possible.

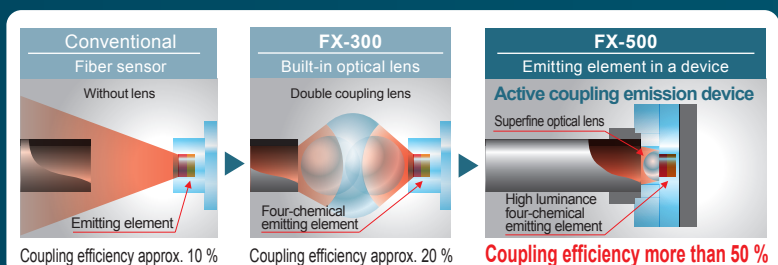

Coupling efficiency = (light intensity directed into the fiber / emission intensity of active coupling emission device) \times 100

* Image



Sharp detection with suppressed hysteresis

So accurate!

The **FX-500** with its accurate detection catches fractional differences in light intensity, achieving high precision and solving low-hysteresis applications.

H-02 mode

Long range detection of small objects with small difference in light intensity

The **FX-500** series achieves a long sensing range by its high intensity beam in addition to suppressed hysteresis. Detection of minute objects over a long range is now more accurate than before.

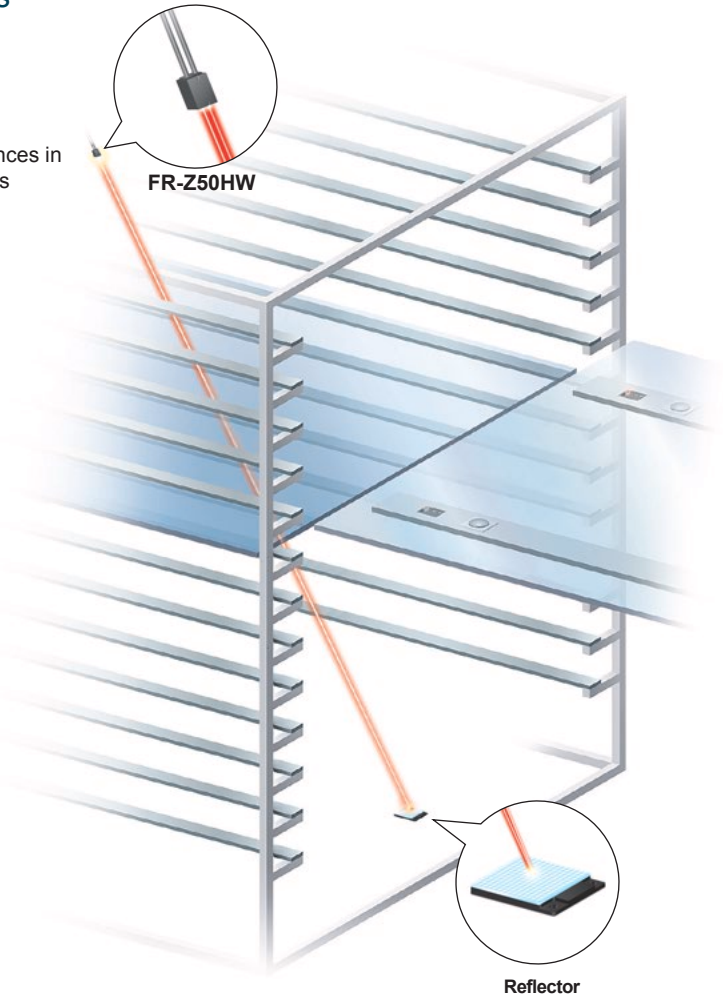

Comparison image

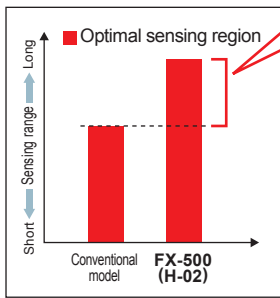

The light intensity difference caused by one sheet of glass can be detected from a more distant point.

H-01 mode

Highly accurate detection while avoiding saturation

Even the light is so strong that it causes saturation, the **FX-500** series cuts down hysteresis to the utmost limit in order to produce the optimal margin for detection.

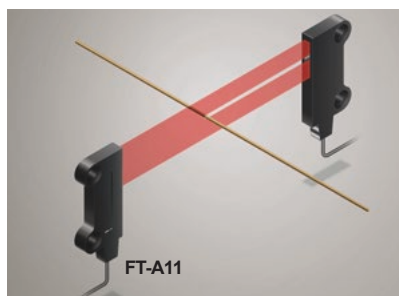

Comparison image

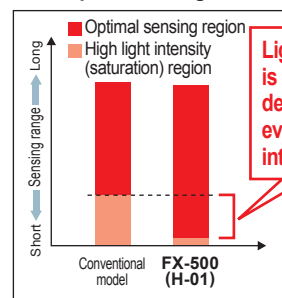

Light saturated region is reduced, and detection is possible even under high light intensity.

Three hysteresis modes

Hysteresis is the difference in incident light intensity at the points when the output turns ON and when the output turns OFF. Hysteresis was originally intended to be used as a measure against vibrations. Three hysteresis modes are available to support the wide variety of applications for which fiber sensors are optimally suited.

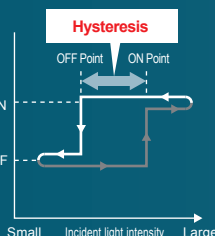

Mode table

Mode	Hysteresis amount	Light intensity	Description
H-01	Minimal	Small	Sharp detection with high accuracy is possible in this mode. Optimal for minute object detection where light saturates easily.
H-02	Small	Large	Initial setting mode. Accurate detection such as long range detection of a large glass substrate is possible.
H-03	Large	Large	A mode used for prevention of chattering. Works in adverse environments such as vibration or dirt.

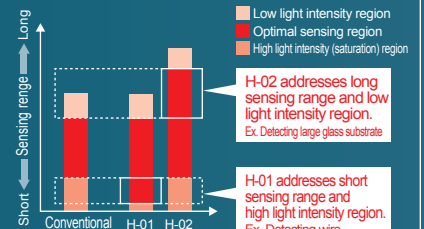

Class leading form and operability

New form!

Flat display with wide viewing angle

The large and high-contrast 7-segment display of high luminance provides clear visibility from a wide angle of view.

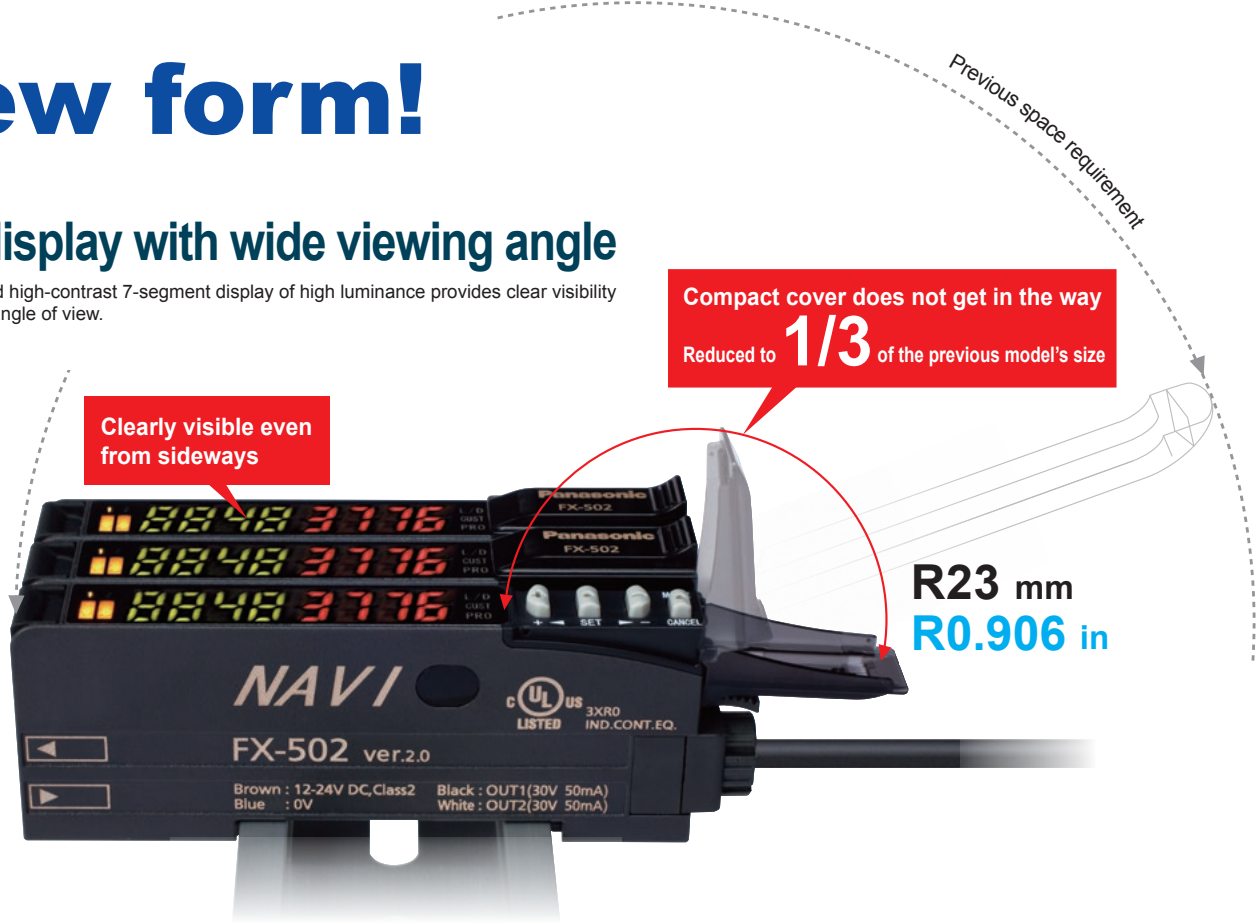

Streamlined fiber clamp

Conventionally clamp operation was performed after opening up the cover. The FX-500 series adopts a guard structure eliminating the cover so that the clamp operation can be done in one step.

MODE NAVI + Direct setting

MODE NAVI uses three indicators and a dual display to show the amplifier's basic operations. The current operation mode can be confirmed at a glance, so even a first-time user can easily operate the amplifier.

Streamlined fiber clamp

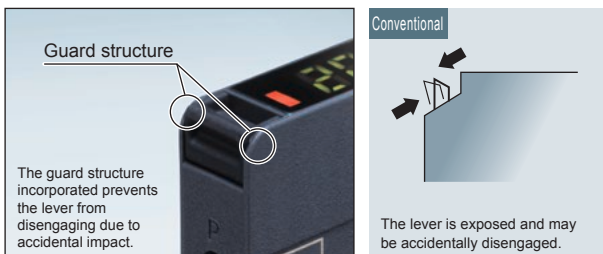
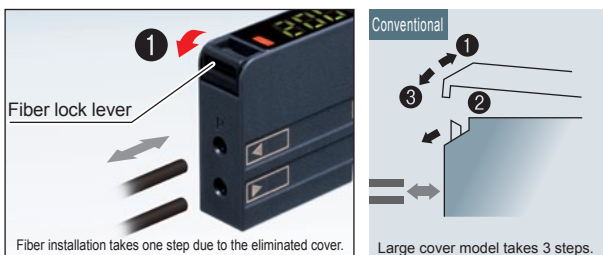

NAVI display (lights off during RUN mode)

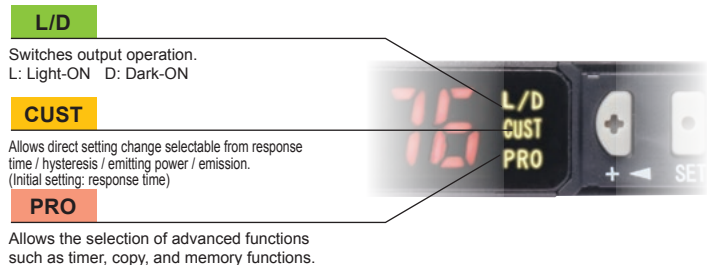

Direct setting



A variety of functions at the industry's leading edge

Stable detection while being eco-friendly

Emission power & gain setting



In cases when the incident light intensity is saturated, the light emitting amount can be adjusted to the optimal level by AUTO without changing the response time. This allows stable detection with an optimal S/N ratio and saves energy by controlling the emitting electric current.

Auto mode (AUTO) and 3-level manual mode (H / M / L [fine-adjustable]) are incorporated.

■ Detecting a transparent sheet

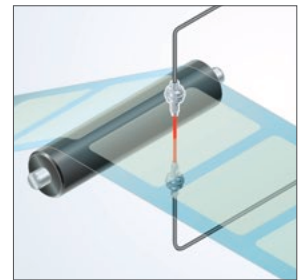
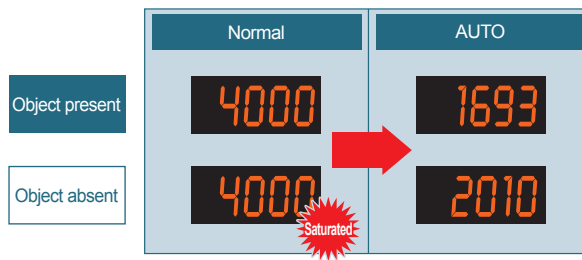

Built-in logic functions

No PLC necessary. Logical calculation with fiber sensor only

■ Logical calculation functions

Three logical calculations (AND, OR, XOR) are available with fiber sensor only. 3 logical operation can be selected against Output 1. Additional controller is not required so both wire-saving and cost reduction can be achieved.

Calculation of two neighboring amplifiers

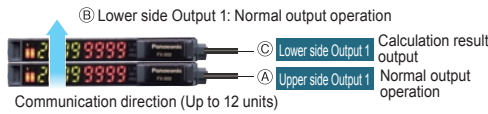

Calculation of two outputs in one amplifier FX-502(P) / FX-505(P)-C2

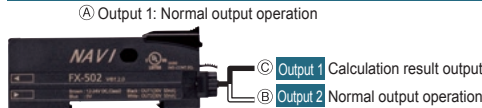

Calculation of one amplifier and external input FX-502(P) / FX-505(P)-C2

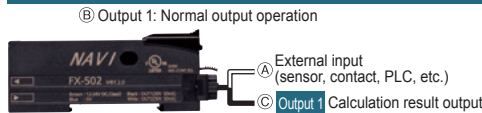

Truth table

A	B	Logical calculation output (C)		
		AND	OR	XOR
ON	ON	ON	ON	OFF
OFF	ON	OFF	ON	ON
ON	OFF	OFF	ON	ON
OFF	OFF	OFF	OFF	OFF

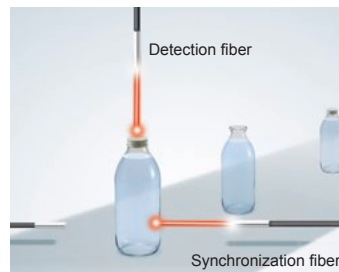

Saves maintenance time

Threshold tracking function

This function performs automatic setting of threshold value by checking the incident light intensity at desired intervals in order to follow the changes in the light amount resulting from changes in the environment over long periods (such as dust). This contributes to reduction in maintenance hours.

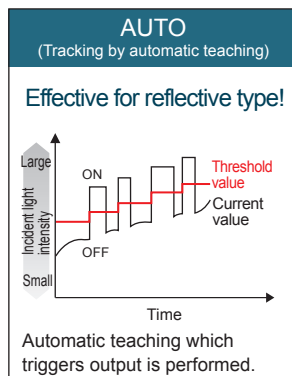
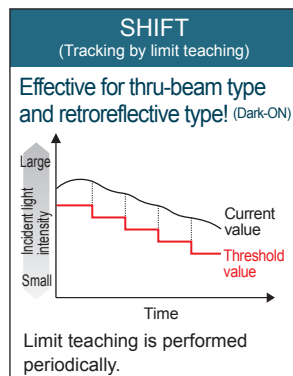

Selectable interference prevention

In addition to the automatic interference prevention function which is enabled through the optical communication of amplifiers mounted in cascade, an alternate frequency interference prevention function is also incorporated. So even for layouts where optical communication cannot be carried out, switching of emission frequencies allows interference prevention.

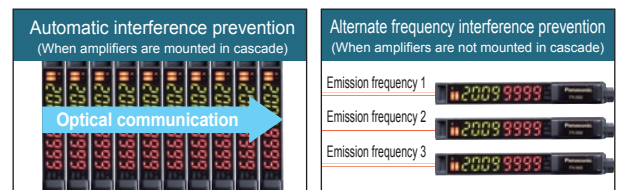

* Refer to specifications for details of number of sensors allowed in interference prevention.

A variety of functions at the industry's leading edge

Resolves variation in displayed incident light intensity

Display adjustment setting

The variation in display can be adjusted to random values. This helps to define proper instruction in a work order.

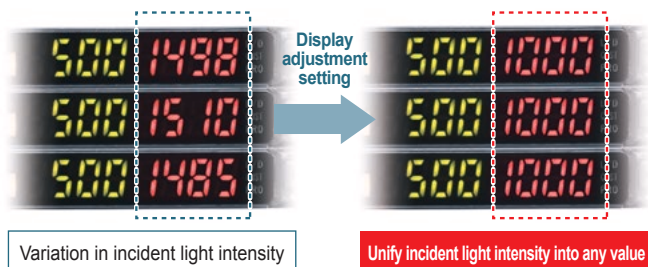

Stable detection over long and short periods

Stabilized emission amount

The "four-chemical emitting element", which we were the first to incorporate to maintain a stable level of light emission, has now become an industry standard.

FX-500 series continues to adopt the same emitting element as well as the "APC (Auto Power Control) circuit" which improves stability in short periods such as when the power is turned on.

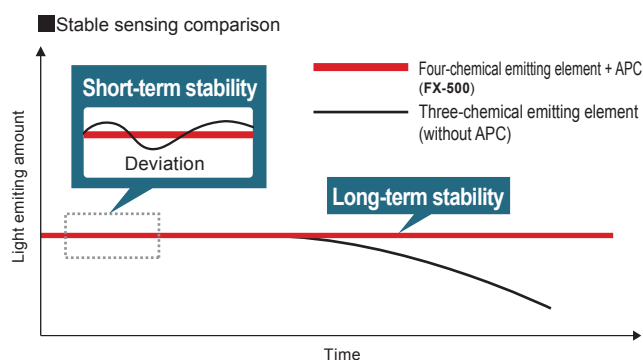

Suitable for preventative maintenance

Self-diagnosis output FX-502(P) / FX-505(P)-C2

FX-502(P) / FX-505(P)-C2 can set Output 2 as a self-diagnosis output. When the teaching of Output 1's threshold value is carried out, Output 2 is set concurrently with the setting randomly shifted by the amount of surplus of threshold value. Light intensity deterioration due to fiber breakage or dust accumulation can be notified as an alarm output.

■ Detect deterioration in light intensity (e.g. Useful in dusty environment)

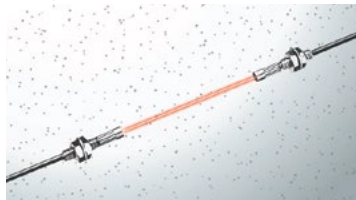

Self-diagnosis can be used with the threshold tracking function for added effectiveness.

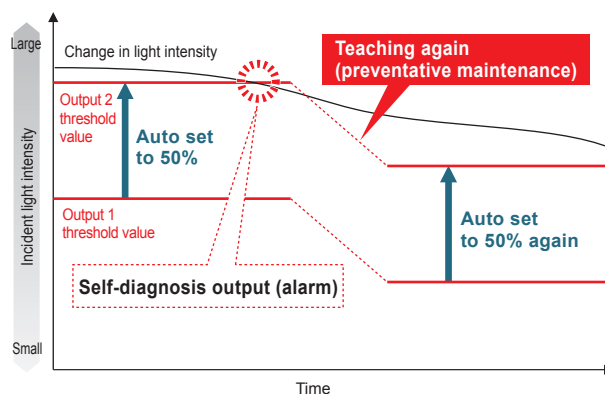

Analog output cable type FX-505(P)-C2

To monitor the sensing of objects, a 4 to 20 mA analog current is output in response to the digital value of the incident light intensity.

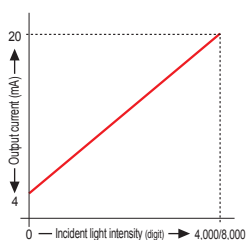

■ Edge tracking of film or sheet

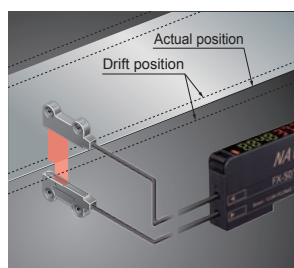

The drifting path can be monitored as the light intensity changes.

8 data banks

Smooth setup changes

The number of data banks used for saving the setup conditions of the amplifier is increased to eight. Setup conditions can be saved and loaded to make setup changes easy at a worksite where multiple models are manufactured.

External input

Remote control improves work efficiency FX-502(P) / FX-505(P)-C2

Work efficiency can be improved by operating via PLC output or other external signal.

(FX-502(P) can operate via external signal when switching from Output 2 to external input.)

■ Functions operable by external input

Full-auto* / Limit* / 2-point teaching*	Display adjustment setting*
Data bank load* / save*	Logical calculation (self-unit only)
Emission halt	Copying function lock (self-unit only)

* FX-505(P)-C2 conducts the answer back output toward external input, when setting Sensing output 2 to the answer back output mode.



Equipped with 5 timer types

A wide variety of timer control operations can be carried out by fiber sensors only.

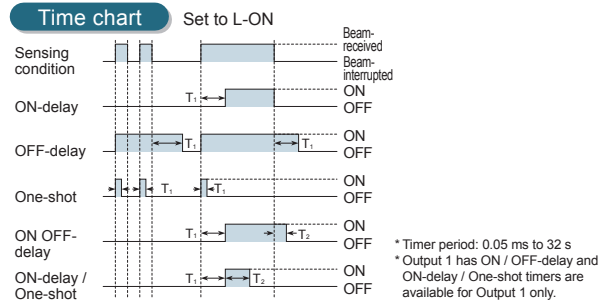

An optical communication function allows sensors to be adjusted simultaneously

The data that is currently set can be copied and saved all at once for all amplifiers connected together from the right side thanks to the optical communication function.

This greatly reduces troublesome setup tasks and makes setup much smoother.



No need to specify a main unit or sub unit

All FX-500 amplifiers can be used as either a main unit or a sub unit. Just use a main cable or a sub cable to distinguish the two. This reduces the costs of inventory management.

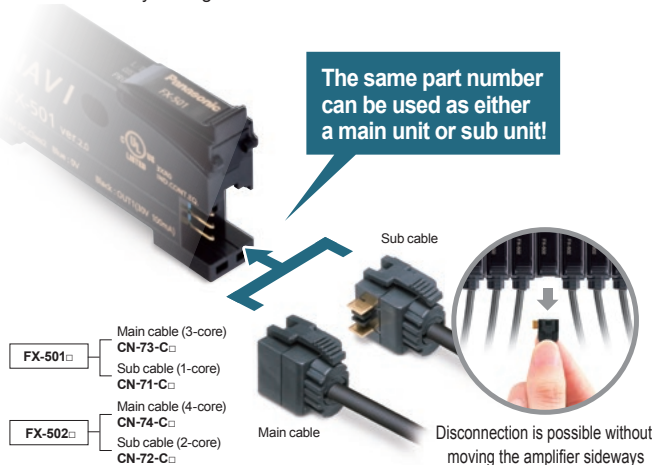

Wire-saving, space-saving

The quick-connection cables enable reduction in wiring. The connections and man-hours required for the relay terminal block setup can be reduced and valuable space is saved.

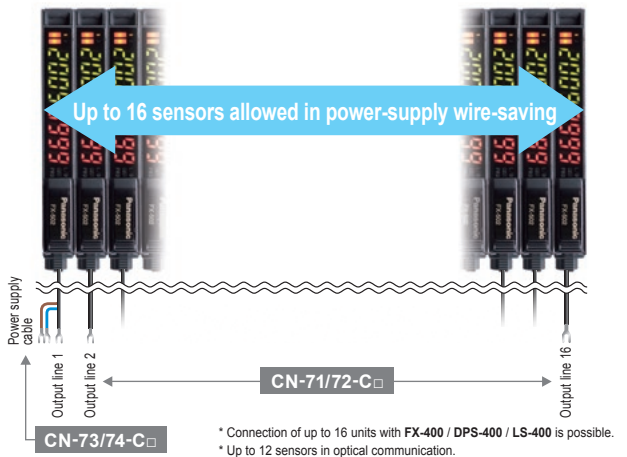

Network communication

Connection to CC-Link IE Field / CC-Link / DeviceNet / EtherCAT open network is possible through the communication unit for open network, SC-GU3 series. Monitoring or setting changes can be carried out via a PLC, PC, etc.

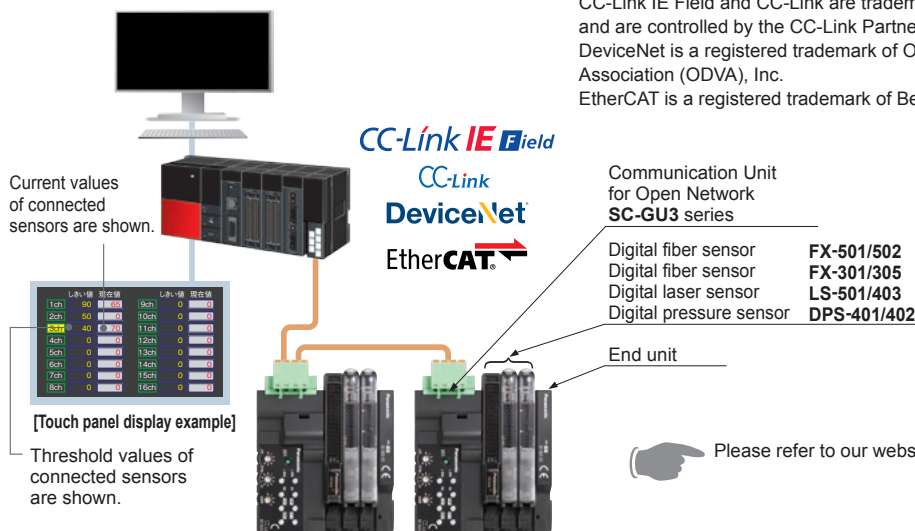

1.6 times longer sensing range than conventional models

Significantly improved stability and usability



Sensing range
1.6 times longer than conventional models

Entry model

Sensing range up to 1.6 times

Ample sensing distance even with thin fiber

The sensing range of the thin reflective type fiber is about 1.6 times longer than that of a conventional product (the sensing range of the standard reflective type fiber is about 1.4 times longer). This adds extra flexibility to the sensor layout.

Fiber	Sensing range (STD mode)		Rate of increase in sensing range
	FX-551	FX-501	
FT-31	480 mm 18.898 in	315 mm 12.402 in	152 %
FT-42	1,470 mm 57.874 in	1,130 mm 44.488 in	130 %
FD-41	200 mm 7.874 in	125 mm 4.921 in	160 %
FD-61	620 mm 24.409 in	450 mm 17.717 in	138 %

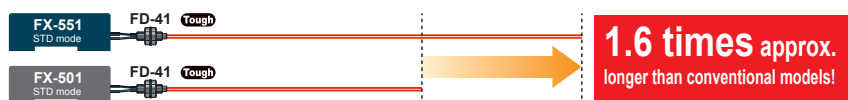

When the hysteresis is the same, the higher incident light intensity results in more stable detection.

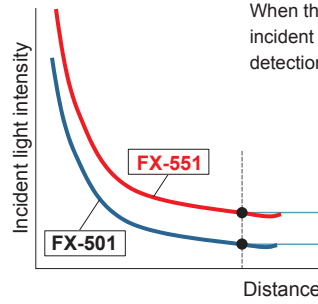

When the hysteresis is the same, the higher incident light intensity results in more stable detection.

Stable detection!

Easy adjustment of beam axis

Thanks to the high emission power, a slight deviation of beam axis causes no problem. It is ideal for use in dusty areas* or for detection through an extremely small slit.

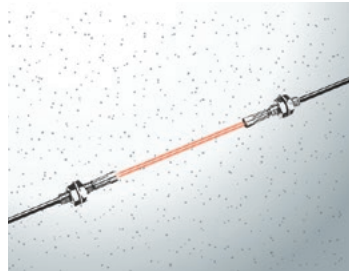

* Need to confirm proper operation in installed condition.

Equipped with a mode to minimize the effect of ambient light

When setting to activate the environment resistance mode in the emission frequency setting, the ambient illuminance for LED lights becomes about 2.5 times higher than that in the normal mode. This reduces erroneous detections caused by LED lights.





Simplified functions for improved operation ease

The **FX-500** series and newer models are equipped with only basic functions for improved ease of use. No matter which model you select, they are all easy to use.

MODE NAVI + Direct setting

MODE NAVI uses three indicators and a dual display to show the amplifier's basic operations. The current operation mode can be confirmed at a glance, so even a first-time user can easily operate the amplifier.

■ NAVI display (lights off during RUN mode)

L/D
Switches output operation.
L: Light-ON D: Dark-ON

CUST
The sensitivity to received light can be changed directly.

PRO
Allows the selection of advanced functions such as timer, shift amount setting and threshold value tracking setting.

■ Direct setting

Direct adjustment

Threshold value can be changed during RUN mode.

Direct teaching

Press once each for object "present" and "absent"

Teaching can be done during RUN mode.

► List of functions in PRO mode

PRO 1	Response time setting, timer setting, shift amount setting
PRO 2	Teaching lock setting, digital display item setting, digital display turning setting, Eco setting
PRO 3	Display adjustment setting, reset setting, emission frequency setting, threshold value tracking setting

No need to specify a main unit or sub unit

All **FX-500** amplifiers can be used as either a main unit or a sub unit. Just use a main cable or a sub cable to distinguish the two. This reduces the costs of inventory management.

Wire-saving, space-saving

The quick-connection cables enable reduction in wiring. The connections and man-hours required for the relay terminal block setup can be reduced and valuable space is saved.

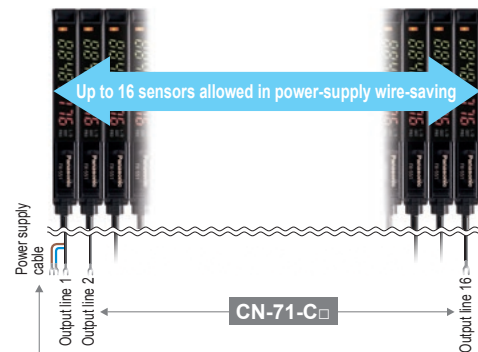

* Connection of up to 16 units with **FX-500 / FX-400 / DPS-400 / LS-400** is possible.
 Note: **FX-550** series is not equipped with a communication function. When connecting to the host communication units **SC-GU3** series, **SC-GU2-C** and **SC-GU1-485**, please use **FX-500** series.

Reduction of the data analysis burden - one small step towards IoT.

IO-Link Compatible, Self-Monitoring Type Self-Monitoring Sensor

IO-Link compatible

Collecting sensor level data

Field data collected and accumulated for “preventive maintenance” and “operation monitoring”.

An analysis of such field data requires high-level know-how and time, causing a burden to people responsible for the production site management.

The **Self-Monitoring Sensor** manufactured by Panasonic is capable of reporting sensor data and its own state to the host device through the I/O Link master.

With the Self-Monitoring Sensor, you can immediately judge the state of the sensor and easily identify the cause of failure.

Thus, this sensor contributes to the **reduction of the burden experienced by the client in collecting and analyzing data.**

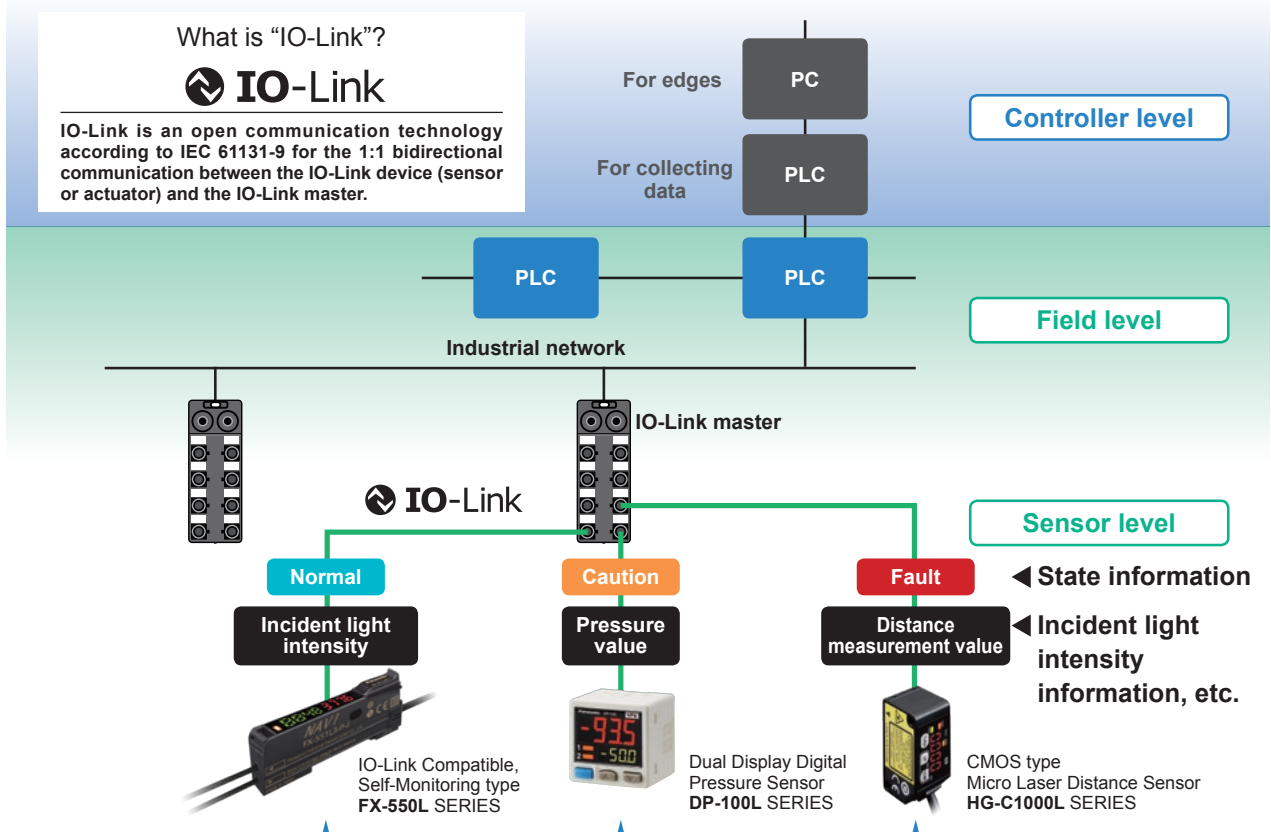

With the Panasonic's Self-Monitoring Sensor, you can leave the sensor to diagnose its own state!

Examples of IoT in the industrial automation field

Before the introduction of Self-Monitoring Sensors

Preventive maintenance

- We want to avoid production line stoppage that might occur due to unexpected sensor failure.
- We want to minimize the production line down time to almost zero.

Line stoppage hours × (manufacturing unit cost / hour) = Loss

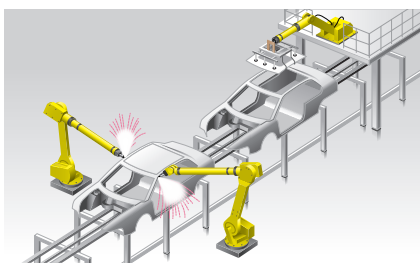

Problems

- ◆ The amount of data to be collected is large and this may lower the PLC processing capacity.
- ◆ The burden of data analysis is large.
- ◆ Resetting the replaced sensors is troublesome.

After the introduction of Self-Monitoring Sensors

From preventive maintenance to predictive maintenance

Leave the sensor diagnosis to the sensor itself.

- All you need to do is to monitor the sensor state.
- PLC can be used exclusively for controlling devices.
- Possible to check detail information at a desired timing.

Leave the resetting for replaced sensors to the higher-level master

- Automatically written from the connected master.
- Possible not only to save time but also to prevent human errors.



Self-monitoring function

With the Panasonic's Self-Monitoring Sensor, you can get high-level solutions!

The introduction of IoT requires collection of the incident light intensity data and presents the following problems.

Previously only ON/OFF data was required. But, due to an addition of the incident light intensity data, the PLC processing burden has increased.

We noticed a change in the incident light intensity. However, because there is no judgment criteria, we cannot tell whether the incident light status is normal or not.

Unless we identify the cause of changes in the incident light intensity, we cannot optimize countermeasures targeting the sensors.

Problems are solved by the high-level self-diagnosis.

Status	Judgement of the state	
Normal	Operation is normal.	
Notification	Check the settings. Detected state is faulty.	* Recover to the normal state through checking installation and settings. Reduction in the incident light intensity
Caution	Getting close to the end of service life. Reached the state where the device should be replaced.	* Limitation in the writing frequency into the memory or in the operation hours, etc.
Fault	Short-circuited or broken. Reached the state where it is impossible to control as a device.	* Short-circuited output, damaged EEPROM, etc.

* By creating a program with a PLC, etc., the "State" of the self-monitoring sensor can be grasped.



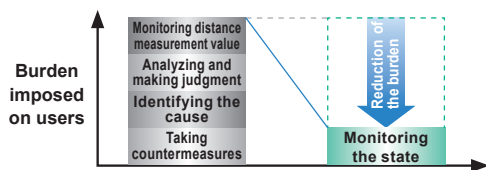

Easy use of IoT



“Predictive maintenance” can be easily achieved through monitoring the state of the Self-Monitoring Sensor.

ORDER GUIDE

Amplifiers Quick-connection cable is not supplied with the amplifier. Please order it separately.

Type		Appearance	Model No.	Emitting element	Output	External input	
FX-500 series	Standard type		FX-501	Red LED	NPN open-collector transistor	_____	
			FX-501P		PNP open-collector transistor		
	2-output type		FX-502		NPN open-collector transistor 2 outputs	Incorporated (Switchable with Output 2)	
			FX-502P		PNP open-collector transistor 2 outputs		
	Cable type				FX-505-C2	NPN open-collector transistor 2 outputs, analog output	Incorporated
					FX-505P-C2	PNP open-collector transistor 2 outputs, analog output	
FX-550 series	Connector type		FX-551	Red LED	NPN open-collector transistor	_____	
			FX-551P		PNP open-collector transistor		
	Cable type		FX-551-C2		NPN open-collector transistor		
			FX-551P-C2		PNP open-collector transistor		
FX-550L series (IO-Link compatible)	Discrete wire type		FX-551L3-P-C2	Red LED	PNP open-collector transistor	_____	
	M12 connector type		FX-551L3-P-J				Supports Smartclick (Note)

Note: Smartclick is a trademark of OMRON Corporation.

ORDER GUIDE

Quick-connection cables

For FX-501(P) / FX-551(P) Quick-connection cable is not supplied with the amplifier. Please order it separately.

Type	Model No.	Length	Description
Main cable (3-core)	CN-73-C1	Length: 1 m 3.281 ft	0.2 mm ² 3-core cabtyre cable, with connector on one end Cable outer diameter: ø3.3 mm ø0.130 in
	CN-73-C2	Length: 2 m 6.562 ft	
	CN-73-C5	Length: 5 m 16.404 ft	
Sub cable (1-core)	CN-71-C1	Length: 1 m 3.281 ft	0.2 mm ² 1-core cabtyre cable, with connector on one end Cable outer diameter: ø3.3 mm ø0.130 in Connectable to a main cable up to 15 cables.
	CN-71-C2	Length: 2 m 6.562 ft	
	CN-71-C5	Length: 5 m 16.404 ft	

Main cable

- CN-73-C□

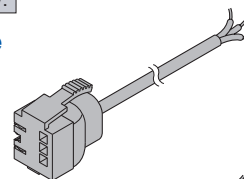

Sub cable

- CN-71-C□

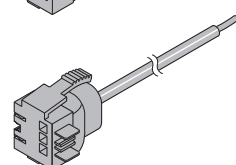

For FX-502(P) Quick-connection cable is not supplied with the amplifier. Please order it separately.

Type	Model No.	Length	Description
Main cable (4-core)	CN-74-C1	Length: 1 m 3.281 ft	0.2 mm ² 4-core cabtyre cable, with connector on one end Cable outer diameter: ø3.3 mm ø0.130 in
	CN-74-C2	Length: 2 m 6.562 ft	
	CN-74-C5	Length: 5 m 16.404 ft	
Sub cable (2-core)	CN-72-C1	Length: 1 m 3.281 ft	0.2 mm ² 2-core cabtyre cable, with connector on one end Cable outer diameter: ø3.3 mm ø0.130 in Connectable to a main cable up to 15 cables.
	CN-72-C2	Length: 2 m 6.562 ft	
	CN-72-C5	Length: 5 m 16.404 ft	

Main cable

- CN-74-C□

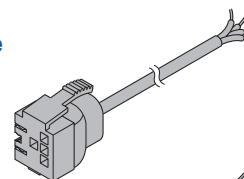

Sub cable

- CN-72-C□

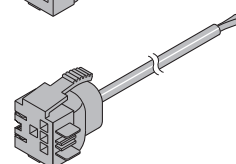

End plates End plates are not supplied with the amplifier. Please order them separately when the amplifiers are mounted in cascade.

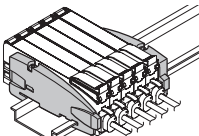
Appearance	Model No.	Description
	MS-DIN-E	When amplifiers are mounted in cascade, or when an amplifier moves depending on the way it is installed on a DIN rail, these end plates clamp amplifiers into place on both sides. Make sure to use end plates when cascading multiple amplifiers together. Two pcs. per set

OPTIONS

Designation	Model No.	Description
Amplifier mounting bracket	MS-DIN-2	Mounting bracket for amplifier

Amplifier mounting bracket

- MS-DIN-2

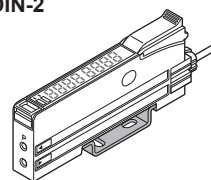

Amplifier protection seal

- FX-MB1
10 sets of 2 communication window seals and 1 connector seal

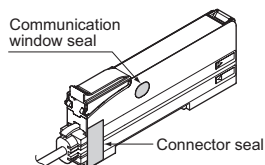

Recommended extension cables for M12 connector type

Manufactured by OMRON Corporation
Extension cable with connectors on both ends XS5W series 

* Smartclick is a trademark of OMRON Corporation. Contact the manufacturer for details of the recommended products.

OPTIONS

Communication unit for open network SC-GU3 series

For FX-501 / FX-502

Designation	Appearance	Model No.	Description
Communication unit for CC-Link IE Field		SC-GU3-04	This is a communication unit, which can convert the output signal of a sensor amplifier (NPN output type) into communication data for CC-Link IE Field.
Communication unit for CC-Link		SC-GU3-01	This is a communication unit, which can convert the output signal of a sensor amplifier (NPN output type) into communication data for CC-Link.
Communication unit for DeviceNet		SC-GU3-02	This is a communication unit, which can convert the output signal of a sensor amplifier (NPN output type) into communication data for DeviceNet.
Communication unit for EtherCAT		SC-GU3-03	This is a communication unit, which can convert the output signal of a sensor amplifier (NPN output type) into communication data for EtherCAT.
End unit		SC-GU3-EU	This end unit can change and check the settings of sensor amplifiers that allow optical communication and monitor operation status. * To obtain the output signal of the FX-502 output 2, optical communication must be performed using the end unit SC-GU3-EU .
Cascading connector unit		SC-71	This one-touch connector is used to connect the following devices to SC-GU3-0□ : The FX-501/502/301/305 fiber sensor, the LS-501/403 laser sensor, the DPS-401/402 digital pressure sensor.

Note: Please refer to our website for details of communication unit for open network **SC-GU3** series.

SPECIFICATIONS

FX-500 series

Item	Model No.	Type	Standard type	2-output type	Cable type	
		NPN output	FX-501	FX-502	FX-505-C2	
		PNP output	FX-501P	FX-502P	FX-505P-C2	
Regulatory compliance		EMC Directive, RoHS Directive, UL/c-UL Listing certification, Korean S mark certification				
Supply voltage		12 to 24 V DC $^{+10}_{-15}$ % Ripple P-P 10 % or less				
Power consumption		Normal operation: 960 mW or less (current consumption 40 mA or less at 24 V supply voltage, excluding analog output of cable type) ECO mode: 680 mW or less (current consumption 28 mA or less at 24 V supply voltage, excluding analog output of cable type)				
Output (2-output type and cable type: Output 1, Output 2)		<NPN output type> NPN open-collector transistor		<PNP output type> PNP open-collector transistor		
		<ul style="list-style-type: none"> Maximum sink current: 100 mA (2-output type and cable type are 50 mA) (Note 2) Applied voltage: 30 V DC or less (between output and 0 V) Residual voltage: 2 V or less (Note 3) (at maximum sink current) 		<ul style="list-style-type: none"> Maximum source current: 100 mA (2-output type and cable type are 50 mA) (Note 2) Applied voltage: 30 V DC or less (between output and +V) Residual voltage: 2 V or less (Note 3) (at maximum source current) 		
		Output points	1 point	2 points		
		Output operation	Switchable either Light-ON or Dark-ON by L/D mode			
		Short-circuit protection	Incorporated			
Response time		H-SP: 25 μ s or less, FAST: 60 μ s or less, STD: 250 μ s or less, LONG: 2 ms or less, U-LG: 4 ms or less, HYPR: 24 ms or less, selectable				
Analog output (Cable type only)		Output current: 4 to 20 mA approx. [H-SP, FAST STD: At 0 to 4,000 digits, LONG: At 0 to 8,000 digits (Note 4)], Response time: 2 ms or less, Zero point: Within 4 mA \pm 1 % F.S., Span: Within 16 mA \pm 5 % F.S., Linearity: Within \pm 3 % F.S., Load resistance: 0 to 250 Ω				
External input (2-output type only, switchable with Output 2)		_____	<NPN output type> NPN non-contact input	<PNP output type> PNP non-contact input		
Possible external input function		_____	Emission halt / Teaching (Full-auto, Limit, 2-point) / Logic operation setting / Copy lock / Display adjustment / Data bank load / Data bank save, selectable			
Sensitivity setting		2-point teaching / Limit teaching / Full-auto teaching / Manual adjustment				
Incident light intensity display range		H-SP / FAST / STD: 0 to 4,000, LONG: 0 to 8,000, U-LG / HYPR: 0 to 9,999				
Timer function		Incorporated with variable OFF-delay / ON-delay / One-shot / ON OFF-delay / ON-delay • One-shot timer, switchable either effective or ineffective		<Output 1> Incorporated with variable OFF-delay / ON-delay / One-shot / ON OFF-delay / ON-delay • One-shot timer, switchable either effective or ineffective		
				<Output 2> Incorporated with variable OFF-delay / ON-delay / One-shot timer, switchable either effective or ineffective		
Timer period		Timer range "ms": 0.5 ms approx., 1 to 9,999 ms approx., 1 ms approx., Timer range "sec.": 0.5 s approx., 1 to 32 s approx., 1 s approx., Timer range "1/10 ms": 0.05 ms approx., 0.1 to 999.9 ms approx., 0.1 ms approx., each output is set individually				
Light emitting amount selection function		Incorporated, 3 levels (each level 25 to 100 %) + Auto setting [1 level (25 to 100 %) when using H-SP mode]				
Interference prevention function		Incorporated (Note 5), selectable either automatic interference prevention or different frequency				
Various settings		Hysteresis setting / Shift amount setting / Emission power setting / Display turning setting / ECO setting / Data bank loading saving setting / Copying setting / Code setting / Reset setting / Logical calculation setting / Threshold tracking setting, etc.				
Protection		IP40 (IEC)				
Ambient temperature		-10 to +55 °C +14 to +131 °F [if 4 to 7 units are mounted in cascade: -10 to +50 °C +14 to +122 °F or if 8 to 16 units (cable type: 8 to 12 units) are mounted in cascade: -10 to +45 °C +14 to +113 °F] (No dew condensation or icing allowed), Storage: -20 to +70 °C -4 to +158 °F				
Vibration resistance		10 to 150 Hz frequency, 0.75 mm 0.030 in double amplitude (10 G max.) in X, Y and Z directions for two hours each				
Shock resistance		98 m/s ² acceleration (10 G approx.) in X, Y and Z directions five times each				
Emitting element (modulated)		Red LED (Peak emission wavelength: 643 nm 0.025 mil)				
Material		Enclosure, Case cover: Polycarbonate, Switch: Polyacetal				
Cable		_____	0.2 mm ² 6-core cabtyre cable, 2 m 6.562 ft long			
Cable extension		_____	Extension up to total 100 m 328.084 ft is possible with 0.3 mm ² , or more, cable. (however, supply voltage 12 V DC)			
Weight		Net weight: 15 g approx., Gross weight: 70 g approx.		Net weight: 60 g approx., Gross weight: 100 g approx.		
Accessory		FX-MB1 (Amplifier protection seal): 1 set				

Notes: 1) Where measurement conditions have not been specified precisely, the conditions used were an ambient temperature of +23 °C +73.4 °F.
 2) 50 mA max. if 5 or more standard types are connected together. (25 mA in case of 2-output type and cable type)
 3) In case of using the quick-connection cable (cable length 5 m 16.404 ft) (optional).
 4) If display adjustment was conducted, it is not in this range.
 5) Number of sensor heads which is possible to be mounted closely in auto interference prevention function depends on response time as shown in table below.
 Number of sensor heads which is possible to be mounted closely in different frequency Interference prevention function is up to 3 units.

• Number of sensor heads mountable closely (Unit: set)

Response time	H-SP	FAST	STD	LONG	U-LG	HYPR
IP-1	0	2	4	8	8	12

SPECIFICATIONS

FX-550 series

Item	Model No.	Type	Connector type	Cable type
		NPN output	FX-551	FX-551-C2
		PNP output	FX-551P	FX-551P-C2
Regulatory compliance		EMC Directive, RoHS Directive		
Supply voltage		12 to 24 V DC ⁺¹⁰ / ₋₁₅ % Ripple P-P 10 % or less		
Power consumption		Normal operation: 960 mW or less (current consumption 40 mA or less at 24 V supply voltage) ECO mode: 680 mW or less (current consumption 28 mA or less at 24 V supply voltage)		
Output	<NPN output type> NPN open-collector transistor		<PNP output type> PNP open-collector transistor	
	<ul style="list-style-type: none"> • Maximum sink current: 100 mA • Applied voltage: 30 V DC or less (between output and 0 V) • Residual voltage: 2 V or less (Note 2) (at maximum sink current) 		<ul style="list-style-type: none"> • Maximum source current: 100 mA • Applied voltage: 30 V DC or less (between output and +V) • Residual voltage: 2 V or less (Note 2) (at maximum source current) 	
	Output operation	Switchable either Light-ON or Dark-ON by L/D mode		
	Short-circuit protection	Incorporated		
Response time		FAST: 60 μs or less, STD: 250 μs or less, LONG: 2 ms or less, U-LG: 4 ms or less, HYPR: 24 ms or less, selectable		
Sensitivity setting		2-point teaching / Limit teaching / Full-auto teaching / Manual adjustment		
Incident light sensitivity setting		Incorporated, 4 steps		
Incident light intensity display range		FAST / STD: 0 to 4,000, LONG: 0 to 8,000, U-LG / HYPR: 0 to 9,999		
Timer function		Incorporated with variable OFF-delay / ON-delay / One-shot / switchable either effective or ineffective		
	Timer period	Timer range "ms": 1 to 9,999 ms approx., 1 ms approx., Timer range "sec.": 1 to 32 s approx., 1 s approx., Timer range "1/10 ms": 0.1 to 999.9 ms approx., 0.1 ms approx. (Note 3)		
Different frequency interference prevention function (Note 4)		Incorporated (up to 4 units). Note that the response time varies depending on the setting. F-1: 0.8 ms or less, F-2: 0.9 ms or less, F-3: 1.0 ms or less, F-4: 1.7 ms or less		
Protection		IP40 (IEC)		
Ambient temperature		-10 to +55 °C +14 to +131 °F (if 4 to 7 units are mounted in cascade: -10 to +50 °C +14 to +122 °F or if 8 to 16 units are mounted in cascade: -10 to +45 °C +14 to +113 °F) (No dew condensation or icing allowed), Storage: -20 to +70 °C -4 to +158 °F		
Vibration resistance		10 to 150 Hz frequency, 0.75 mm 0.030 in double amplitude (10 G max.) in X, Y and Z directions for two hours each		
Shock resistance		98 m/s ² acceleration (10 G approx.) in X, Y and Z directions five times each		
Emitting element (modulated)		Red LED (Peak emission wavelength: 660 nm 0.026 mil)		
Material		Enclosure, Case cover: Polycarbonate, Switch: Polyacetal		
Cable		—	0.2 mm ² 3-core cabtyre cable, 2 m 6.562 ft long	
Cable extension		—	Extension up to total 100 m 328.084 ft is possible with 0.3 mm ² , or more, cable. (however, supply voltage 12 V DC or more)	
Weight		Net weight: 15 g approx., Gross weight: 55 g approx.		Net weight: 55 g approx., Gross weight: 90 g approx.

- Notes: 1) Where measurement conditions have not been specified precisely, the conditions used were an ambient temperature of +23 °C **+73.4 °F**.
 2) In case of using the quick-connection cable (cable length 5 m **16.404 ft**) (optional).
 3) When set to LONG, U-LG, HYPR, IP-F or IP-R, the time range cannot be set to 1/10 ms.
 4) This function increases the hysteresis. Check the sensing condition when using the function.

SPECIFICATIONS

FX-550L series

Type		Discrete wire type	M12 connector type
Item	Model No.	FX-551L3-P-C2	FX-551L3-P-J
Regulatory compliance		EMC Directive, RoHS Directive	
Supply voltage		12 to 24 V DC $+10\%$ / -15% Ripple P-P 10 % or less	
Power consumption		Normal operation: 960 mW or less (current consumption 40 mA or less at 24 V supply voltage) ECO mode: 720 mW or less (current consumption 30 mA or less at 24 V supply voltage)	
Communication output (C/Q) (Note 2)	IO-Link communication	IO-Link Specification V1.1	
	Baud rate	COM3 (230.4 kbps)	
	Process data	4 byte	
	Minimum cycle time	1.0 ms	
Control output (DO)		PNP open-collector transistor <ul style="list-style-type: none"> • Maximum source current: 50 mA • Applied voltage: 30 V DC or less (between output and +V) • Residual voltage: 2 V or less (Note 3) (at maximum source current) 	
	Output operation	Switchable either Light-ON or Dark-ON by L/D mode	
	Short-circuit protection	Incorporated	
Response time		STD: 250 μ s or less, LONG: 2 ms or less, U-LG: 4 ms or less, HYPR: 24 ms or less, selectable	
Sensitivity setting		2-point teaching / Limit teaching / Full-auto teaching / Manual adjustment	
Incident light sensitivity setting		Incorporated, 4 steps	
Incident light intensity display range		STD: 0 to 4,000, LONG: 0 to 8,000, U-LG / HYPR: 0 to 9,999	
Timer function		Incorporated with variable OFF-delay / ON-delay / One-shot, switchable either effective or ineffective	
	Timer period	0.1 to 999.9 ms approx., in units of 0.1 ms approx.	
Different frequency interference prevention function (Note 4)		Incorporated (up to 4 units). Note that the response time varies depending on the setting. F-1: 0.8 ms or less, F-2: 0.9 ms or less, F-3: 1.0 ms or less, F-4: 1.7 ms or less	
Protection		IP40 (IEC)	
Ambient temperature		-10 to +55 °C +14 to +131 °F (If 4 to 7 units are mounted in cascade: -10 to +50 °C +14 to +122 °F or if 8 to 16 units are mounted in cascade: -10 to +45 °C +14 to +113 °F) (No dew condensation or icing allowed), Storage: -20 to +70 °C -4 to +158 °F	
Vibration resistance		10 to 150 Hz frequency, 0.75 mm 0.030 in double amplitude (10 G max.) in X, Y and Z directions for two hours each	
Shock resistance		98 m/s ² acceleration (10 G approx.) in X, Y and Z directions five times each	
Emitting element (modulated)		Red LED (Peak emission wavelength: 660 nm 0.026 mil)	
Material		Enclosure, Case cover: Polycarbonate, Switch: Polyacetal	
Cable		0.2 mm ² 4-core cabtyre cable, 2 m 6.562 ft long	0.2 mm ² cabtyre cable with M12 connector, 0.3 m 0.984 ft long
Cable extension		Extension up to total 20 m 65.617 ft is possible with 0.3 mm ² , or more, cable. (Condition of CE compliance: less than 20 m 65.617 ft) (however, supply voltage 12 V DC or more)	
Weight		Net weight: 55 g approx., Gross weight: 80 g approx.	Net weight: 35 g approx., Gross weight: 60 g approx.

Notes: 1) Where measurement conditions have not been specified precisely, the conditions used were an ambient temperature of +23 °C **+73.4 °F**.

2) When the sensor is used as an ordinary sensor, the communication output (C/Q) provides the same output operation as the control output (DO).

3) In case of using the cable (cable length 2 m **6.562 ft**).

4) This function increases the hysteresis. Check the sensing condition when using the function.

I/O CIRCUIT AND WIRING DIAGRAMS

FX-501 FX-551 FX-551-C2

NPN output type

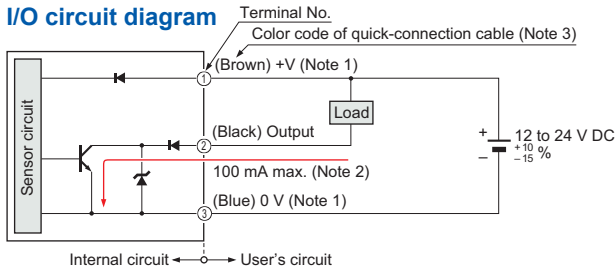

- Notes: 1) The quick-connection sub cable does not have +V (brown) and 0 V (blue). The power is supplied from the connector of the main cable.
 2) 50 mA max., if five amplifiers or more, are connected together.
 3) The color of the lead wire of the FX-551-C2 is the same.

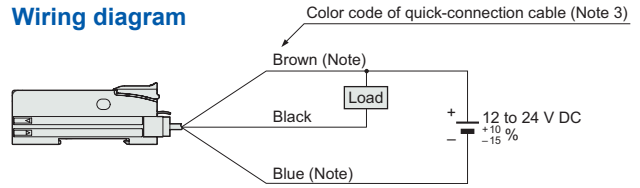

Note: The quick-connection sub cable does not have a brown and a blue lead wire.

Terminal arrangement diagram

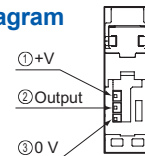

FX-501P FX-551P FX-551P-C2

PNP output type

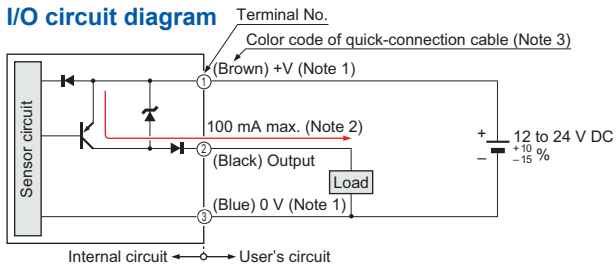

- Notes: 1) The quick-connection sub cable does not have +V (brown) and 0 V (blue). The power is supplied from the connector of the main cable.
 2) 50 mA max., if five amplifiers or more, are connected together.
 3) The color of the lead wire of the FX-551P-C2 is the same.

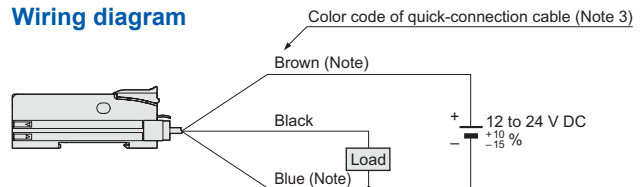

Note: The quick-connection sub cable does not have a brown and a blue lead wire.

Terminal arrangement diagram

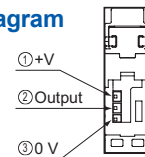

FX-502

NPN output type

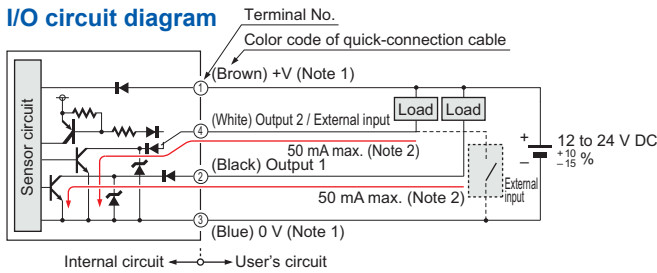

- Notes: 1) The quick-connection sub cable does not have +V (brown) and 0 V (blue). The power is supplied from the connector of the main cable.
 2) 25 mA max., if five amplifiers or more, are connected together.

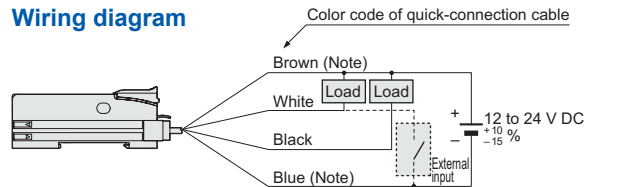

Note: The quick-connection sub cable does not have a brown and a blue lead wire.

Terminal arrangement diagram

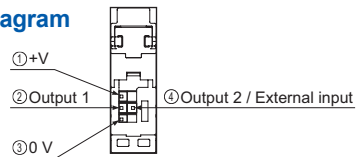

FX-502P

PNP output type

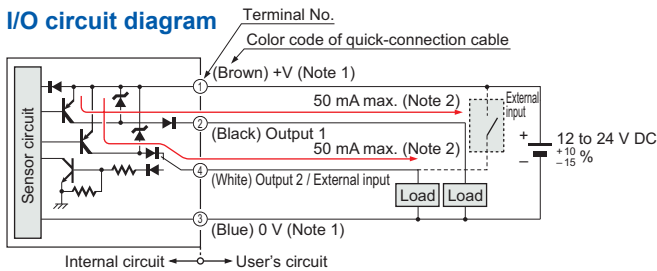

- Notes: 1) The quick-connection sub cable does not have +V (brown) and 0 V (blue). The power is supplied from the connector of the main cable.
 2) 25 mA max., if five amplifiers or more, are connected together.

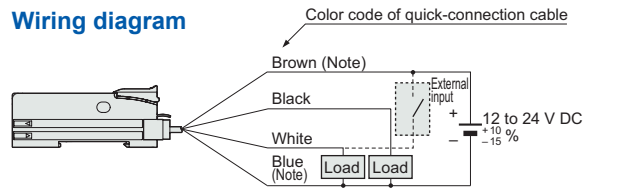

Note: The quick-connection sub cable does not have a brown and a blue lead wire.

Terminal arrangement diagram

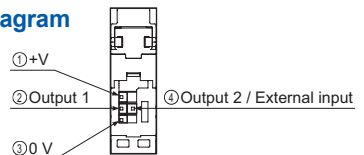

I/O CIRCUIT AND WIRING DIAGRAMS

FX-505-C2 NPN output type

I/O circuit diagram

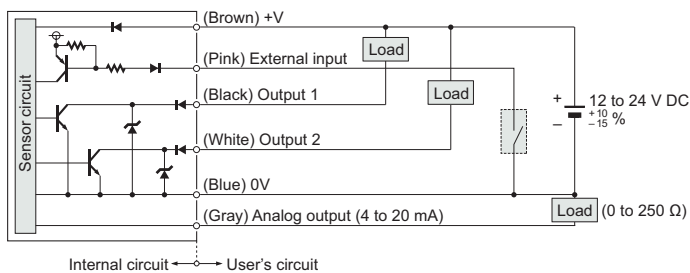

Wiring diagram

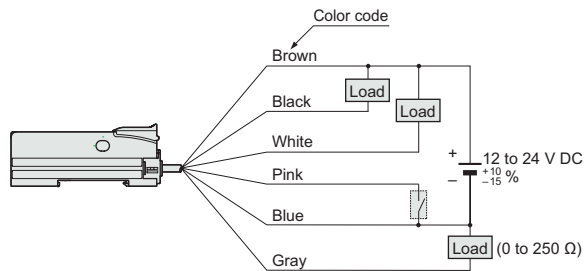

FX-505P-C2 PNP output type

I/O circuit diagram

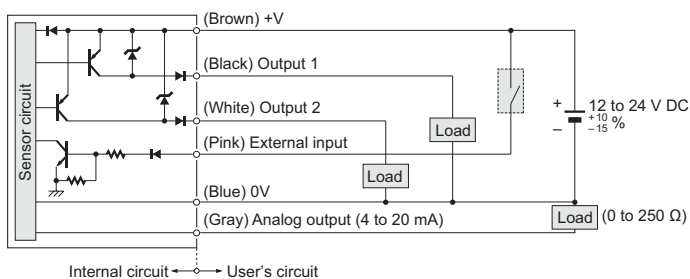

Wiring diagram

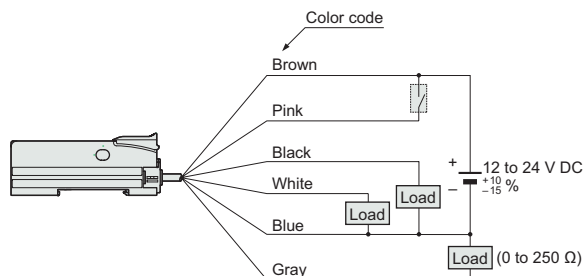

WIRING DIAGRAMS

FX-551L3-P-J M12 connector type

<When using as an ordinary sensor>

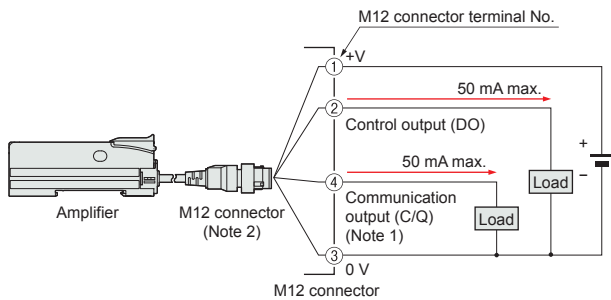

<When connecting to the IO-Link master>

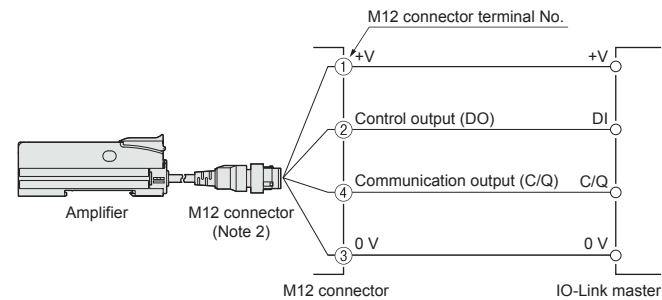

- Notes: 1) When the sensor is used as an ordinary sensor, the communication output (C/Q) provides the same output operation as the control output (DO).
 2) When wiring with the discrete wire or extending the cable from the M12 connector, separately prepare commercially available M12 connector cable.

M12 connector terminal arrangement diagram

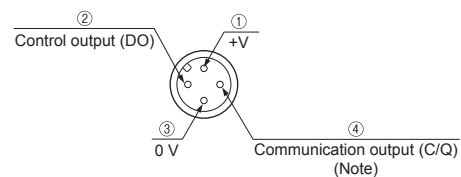

Terminal No.	Designation
①	+V
②	Control output (DO)
③	0 V
④	Communication output (C/Q) (Note)

Note: When the sensor is used as an ordinary sensor, the communication output (C/Q) provides the same output operation as the control output (DO).

WIRING DIAGRAMS

FX-551L3-P-C2

Discrete wire type

<When using as an ordinary sensor>

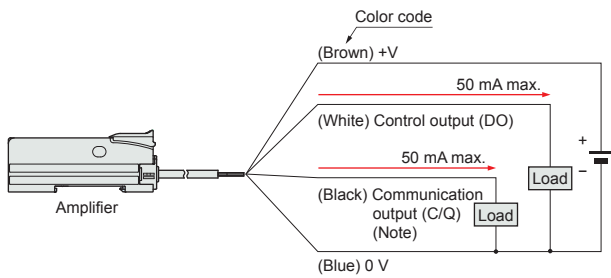

<When connecting to the IO-Link master>

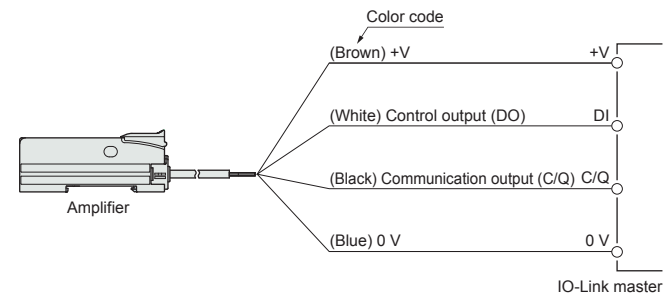

Note: When the sensor is used as an ordinary sensor, the communication output (C/Q) provides the same output operation as the control output (DO).

PRECAUTIONS FOR PROPER USE

• This catalog is a guide to select a suitable product. Be sure to read instruction manual attached to the product prior to its use.



- Never use this product as a sensing device for personnel protection.
- In case of using sensing devices for personnel protection, use products which meet laws and standards, such as OSHA, ANSI or IEC etc., for personnel protection applicable in each region or country.

Wiring

- Make sure that the power supply is OFF while adding or removing the amplifiers.
- Note that if a voltage exceeding the rated range is applied, or if an AC power supply is directly connected, the product may get burnt or damaged.
- Note that short-circuit of the load or wrong wiring may burn or damage the product.
- Do not run the wires together with high-voltage lines or power lines, or put them in the same raceway. This can cause malfunction due to induction.
- Verify that the supply voltage variation is within the rating.
- If power is supplied from a commercial switching regulator, ensure that the frame ground (F.G.) terminal of the power supply is connected to an actual ground.
- In case noise generating equipment (switching regulator, inverter motor, etc.) is used in the vicinity of this product, connect the frame ground (F.G.) terminal of the equipment to an actual ground.
- Make sure to use the quick-connection cable (optional) for **FX-500/550** series. Extension up to total 100 m **328.084 ft** is possible with 0.3 mm² or more, cable. However, in order to reduce noise, make the wiring as short as possible.

Refer to the instruction manual for details. The instruction manual data can be downloaded from our website.

- When extending the cable length of **FX-550L** series, use a cable with a conductor cross-sectional area of 0.3 mm² or more. Note that the maximum allowed cable length is 20 m **65.617 ft** (CE Marking condition: less than 20 m **65.617 ft**). However, in order to reduce noise, make the wiring as short as possible.
- Make sure that stress by forcible bending or pulling is not applied to the sensor cable joint and fiber cable.

Others

- This product has been developed / produced for industrial use only.
- The specification may not be satisfied in a strong magnetic field.
- The ultra long distance (U-LG, HYPR) mode is more likely to be affected by extraneous noise since the sensitivity of that is higher than the other modes. Make sure to check the environment before use.
- Do not use during the initial transient time after the power supply is switched ON.
 - FX-500 series**
H-SP, FAST, STD: 0.5 sec., LONG, U-LG, HYPR: 1 sec.
 - FX-550 series**
FAST, STD: 0.5 sec., LONG, U-LG, HYPR: 1 sec.
 - FX-550L series**
STD: 0.5 sec., LONG, U-LG, HYPR: 1 sec.
- These sensors are only for indoor use.
- Avoid dust, dirt, and steam.
- Make sure that the product does not come in contact with oil, grease, organic solvents such as thinner, etc., strong acid or alkaline.
- This product cannot be used in an environment containing inflammable or explosive gases.
- Never disassemble or modify this product.
- This product adopts EEPROM. Settings cannot be done a million times or more because of the EEPROM's lifetime.

DIMENSIONS (Unit: mm in)

Refer to our website for fiber dimensions.
The CAD data can be downloaded from our website.

FX-501 FX-501P FX-502 FX-502P Amplifier

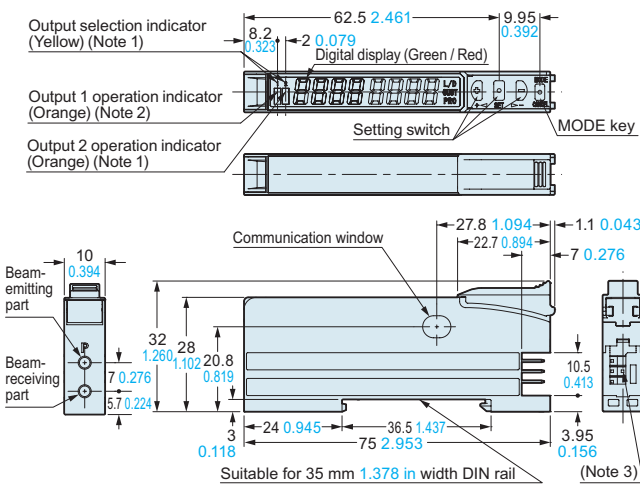

- Notes: 1) FX-502(P) only
2) FX-501(P): Operation indicator
3) FX-501(P): 3-pin, FX-502(P): 4-pin

FX-505-C2 FX-505P-C2 Amplifier

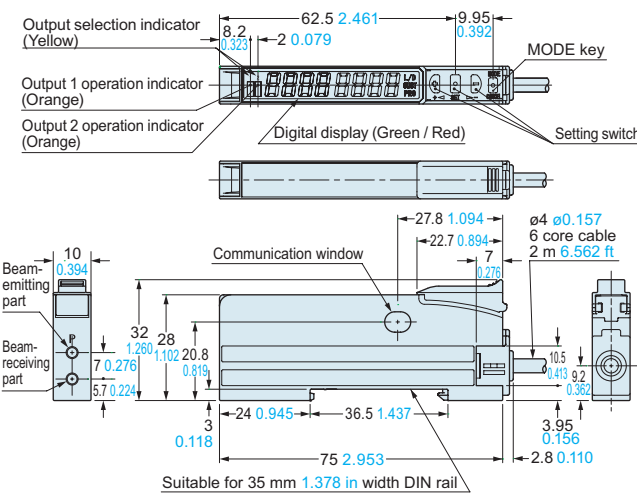

FX-551 FX-551P Amplifier

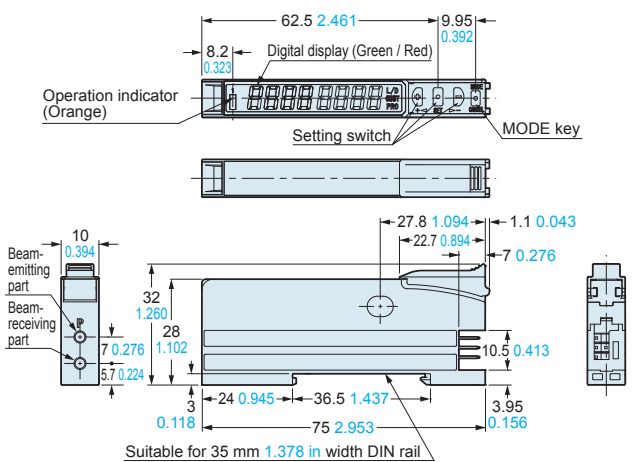

FX-551-C2 FX-551P-C2 Amplifier

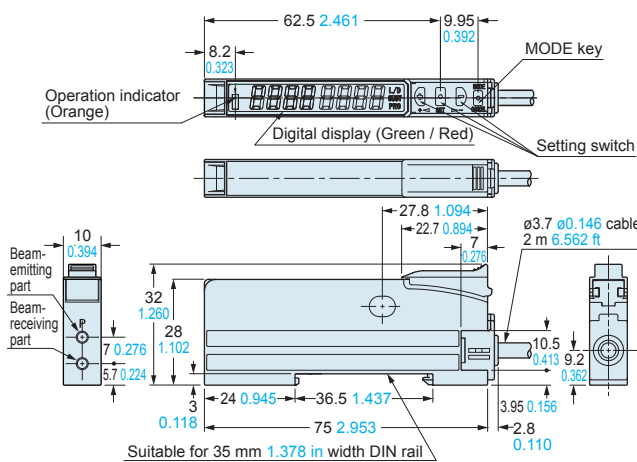

FX-551L3-P-C2 Amplifier

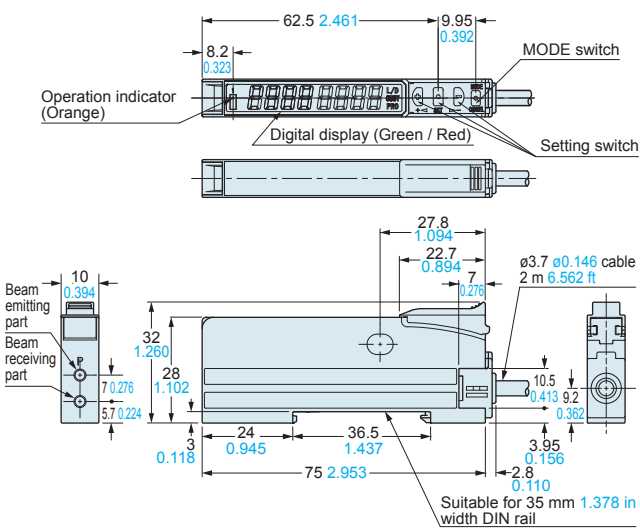

DIMENSIONS (Unit: mm in)

Refer to our website for fiber dimensions.
The CAD data can be downloaded from our website.

FX-551L3-P-J

Amplifier

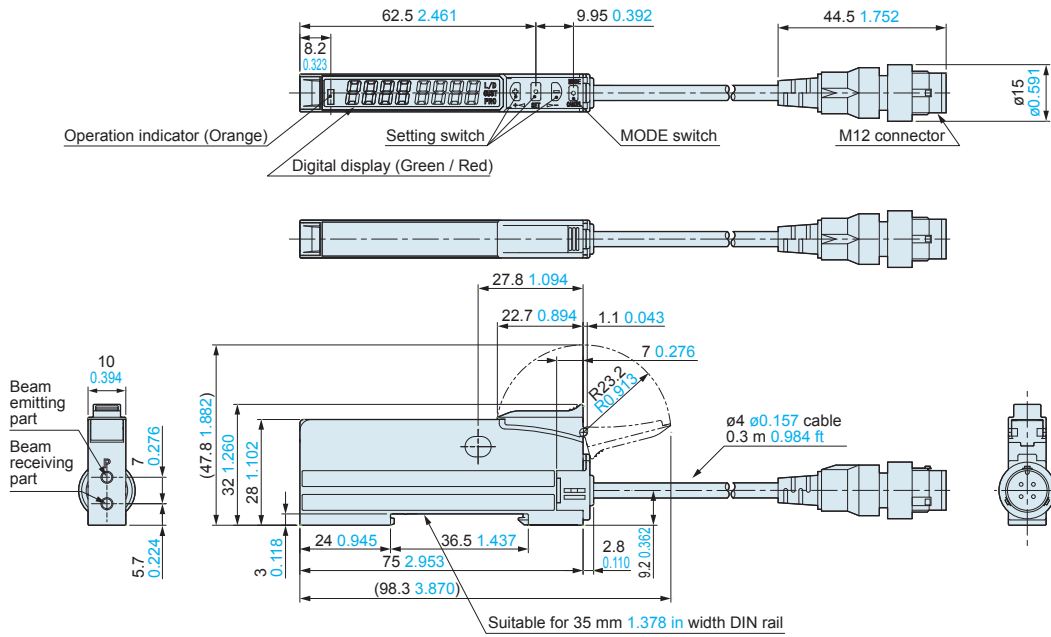

CN-73-C □ CN-74-C □ Main cable (Optional)

• Length L

Model No.	Length L
CN-73/74-C1	1,000 39.370
CN-73/74-C2	2,000 78.740
CN-73/74-C5	5,000 196.850

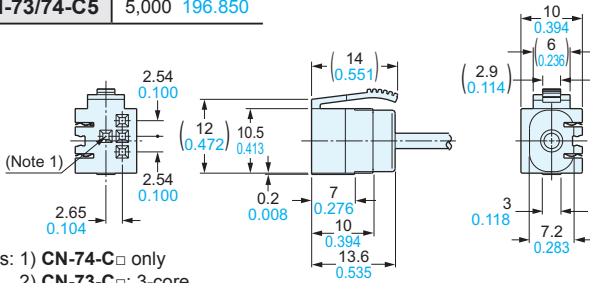
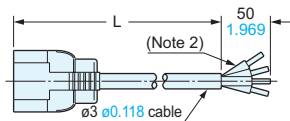

Notes: 1) CN-74-C □ only
2) CN-73-C □: 3-core

CN-71-C □ CN-72-C □ Sub cable (Optional)

• Length L

Model No.	Length L
CN-71/72-C1	1,000 39.370
CN-71/72-C2	2,000 78.740
CN-71/72-C5	5,000 196.850

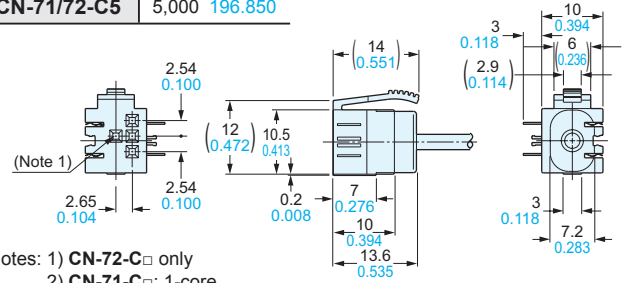
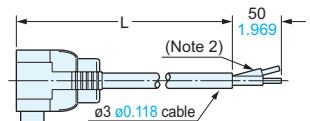

Notes: 1) CN-72-C □ only
2) CN-71-C □: 1-core

MS-DIN-2 Amplifier mounting bracket (Optional)

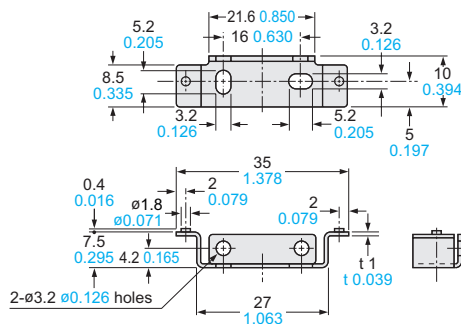

Material: Cold rolled carbon steel (SPCC)
(Uni-chrome plated)

MS-DIN-E End plate (Optional)

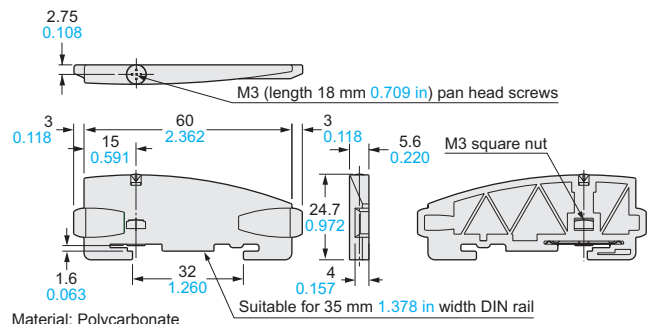

Material: Polycarbonate

Tough : Refer to a fiber which possesses both unbreakable (bending radius: R10 mm R0.394 in, reciprocating bending: 180°) and more flexible (bending radius: R4 mm R0.157 in or less) features.
Bending durability : Refer to a fiber which possesses unbreakable bending-resistant feature (bending radius: R10 mm R0.394 in, reciprocating bending: 180°).

LIST OF FIBERS

Super quality type

*Thru-beam type sensors are available as two pieces per set.

Type	Shape of fiber head (mm)	Model No.	Bending radius (mm)	Fiber cable length	Sensing range (mm in) (Note 2, 3)				Beam axis position / Inclination of beam axis (mm)	Optical transmission loss	Protection	Ambient temp.		
					FX-500 series	Other modes	U-LG LONG FAST H-SP	FX-550 / FX-550L series					Other modes	U-LG LONG FAST
Thru-beam	Threaded	M3	Tough (Bending durability)	R2	2 m (Note 4)	STD 400 15.748 HYPR 1,350 53.150	810 31.890 650 25.591 210 8.268 75 2.953	STD 570 22.441 HYPR 1,860 73.228	1,240 48.819 830 32.677 340 13.386	ø0.5	150 µm / ±2°	±10 %	IP67	-55 to +80 °C
		M4	Tough (Bending durability)	R4		STD 1,200 47.244 HYPR 3,600 141.732	2,200 86.614 1,700 66.929 530 20.866 190 7.480	STD 1,570 61.811 HYPR 3,600 141.732 (Note 1)	3,100 122.047 2,200 86.614 960 37.795					
	Cylindrical	ø1.5	Tough (Bending durability)	R2		STD 400 15.748 HYPR 1,350 53.150	810 31.890 650 25.591 210 8.268 75 2.953	STD 550 21.654 HYPR 1,760 69.291	1,200 47.244 800 31.496 340 13.386					
		ø3	Tough (Bending durability)	R4		STD 1,200 47.244 HYPR 3,600 141.732	2,200 86.614 1,700 66.929 530 20.866 190 7.480	STD 1,650 64.961 HYPR 3,600 141.732 (Note 1)	3,100 122.047 2,250 88.583 1,000 39.370					
Reflective	Threaded	M3	Tough (Bending durability)	R2	2 m (Note 4)	STD 160 6.299 HYPR 600 23.622	330 12.992 250 9.843 80 3.150 25 0.984	STD 210 8.268 HYPR 800 31.496	460 18.110 330 12.992 140 5.512	—	150 µm / ±3°	±10 %	IP67	-55 to +80 °C
		M4	Tough (Bending durability)	R4		STD 520 20.472 HYPR 1,550 61.024	900 35.433 740 29.134 260 10.236 90 3.543	STD 750 29.528 HYPR 1,750 68.898	1,300 51.151 970 38.189 420 16.535					
	M6	Tough (Bending durability)	R4	STD 160 6.299 HYPR 600 23.622		330 12.992 250 9.843 80 3.150 25 0.984	STD 220 8.661 HYPR 800 31.496	500 19.685 330 12.992 140 5.512						
	Cylindrical	ø3	Tough (Bending durability)	R4		STD 160 6.299 HYPR 600 23.622	330 12.992 250 9.843 80 3.150 25 0.984	STD 220 8.661 HYPR 800 31.496	500 19.685 330 12.992 140 5.512					

- Notes: 1) The fiber cable length practically limits the sensing range.
 2) The sensing range of reflective type is specified for white non-glossy paper.
 3) The FX-550L series does not have FAST mode.
 4) It is not a free-cut type.

Tough : Refer to a fiber which possesses both unbreakable (bending radius: R10 mm **R0.394 in**, reciprocating bending: 180°) and more flexible (bending radius: R4 mm **R0.157 in** or less) features.
Bending durability : Refer to a fiber which possesses unbreakable bending-resistant feature (bending radius: R10 mm **R0.394 in**, reciprocating bending: 180°).

LIST OF FIBERS

Threaded type

*Thru-beam type sensors are available as two pieces per set.



Type	Shape of fiber head (mm)	Model No.	Bending radius (mm)	Fiber cable length Free-cut	Sensing range (mm in) (Note 1, 3)				Beam axis dia. (mm)	Beam axis position / Inclination of beam axis	Protection	Ambient temp.		
					FX-500 series	Other modes	U-LG LONG FAST H-SP	FX-550 / FX-550L series					Other modes	U-LG LONG FAST
Thru-beam Threaded	M3	Tough (Bending durability) FT-31	R2	Free-cut	STD 315 12.402 HYPR 1,350 53.150	770 30.315 550 21.654 210 8.268 70 2.756	480 18.898 HYPR	1,000 39.370 700 27.559 290 11.417	ø0.5	150 µm / ±2°	IP67	-55 to +80 °C		
		FT-31W	R1		STD 260 10.236 HYPR 990 38.976	590 23.228 440 17.323 150 5.906 53 2.087	420 16.535 HYPR	890 35.039 580 22.835 250 9.843					150 µm / ±3°	-40 to +60 °C
		Tough (Bending durability) FT-32	R2		STD 3,000 118.110 HYPR (Note 2) 3,600 141.732	3,600 141.732 (Note 2) 3,600 141.732 (Note 2) 1,600 62.992 580 22.835	STD 3,600 141.732 (Note 2) HYPR 3,600 141.732 (Note 2)	3,600 141.732 (Note 2) 3,600 141.732 (Note 2) 2,900 114.173					ø1.6	—
	M4	Lens mountable FT-43	R4		STD 1,400 55.118 HYPR (Note 2) 3,600 141.732	2,800 110.236 2,100 82.677 770 30.315 240 9.449	STD 2,200 86.614 HYPR	3,600 141.732 (Note 2) 3,600 141.732 (Note 2)	3,600 141.732 (Note 2) 3,100 122.047 1,400 55.118	ø1.5	150 µm / ±2°	IP67	-55 to +80 °C	
		Lens mountable FT-42	R1		STD 1,130 44.488 HYPR (Note 2) 3,600 141.732	2,050 80.709 1,600 62.992 530 20.866 190 7.480	STD 1,470 57.874 HYPR	2,900 114.173 2,100 82.677 890 35.039						
		Lens mountable FT-42W	R1		STD 800 31.496 HYPR (Note 2) 3,300 129.921	1,900 74.803 1,400 55.118 490 19.291 160 6.299	STD 1,200 47.244 HYPR	2,600 102.362 (Note 2) 1,780 70.079 710 27.953						
		Lens mountable, Stainless-jacketed FT-45X	R4		STD 1,200 47.244 HYPR (Note 2) 1,600 62.992	1,600 62.992 (Note 2) 1,600 62.992 (Note 2) 630 24.803 200 7.874	STD 1,600 62.992 (Note 2) HYPR 1,600 62.992 (Note 2)	1,600 62.992 (Note 2) 1,600 62.992 (Note 2) 1,070 42.126						
	Elbow	Lens mountable FT-R40	R4		STD 930 36.614 HYPR (Note 2) 3,600 141.732	1,750 68.898 1,500 59.055 500 19.685 160 6.299	STD 1,400 55.118 HYPR	2,900 114.173 1,950 76.772 860 33.858	ø1	150 µm / ±2°	IP67	-55 to +80 °C		
	M14 Long range	With expansion lens FT-140	R4		STD 19,600 771.654 HYPR (Note 2) 19,600 771.654	19,600 771.654 (Note 2) 19,600 771.654 (Note 2) 16,000 629.921 6,300 248.031	STD 19,600 771.654 (Note 2) HYPR 19,600 771.654 (Note 2)	19,600 771.654 (Note 2) 19,600 771.654 (Note 2) 19,600 771.654 (Note 2)					ø10	—

- Notes: 1) Note that the sensing range of the free-cut type fiber may be reduced by 20 % max. depending upon how the fiber is cut.
 2) The fiber cable length practically limits the sensing range.
 3) The FX-550L series does not have FAST mode.

Tough : Refer to a fiber which possesses both unbreakable (bending radius: R10 mm **R0.394 in**, reciprocating bending: 180°) and more flexible (bending radius: R4 mm **R0.157 in** or less) features.
Bending durability : Refer to a fiber which possesses unbreakable bending-resistant feature (bending radius: R10 mm **R0.394 in**, reciprocating bending: 180°).

LIST OF FIBERS

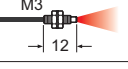
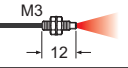
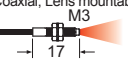
Threaded type

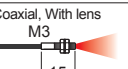
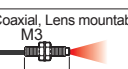
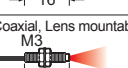
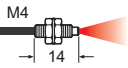
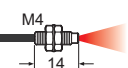
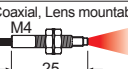
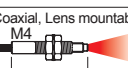
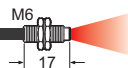
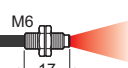
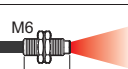
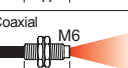
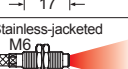
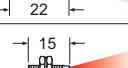
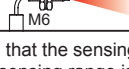
Type	Shape of fiber head (mm)	Model No.	Bending radius (mm)	Fiber cable length Free-cut	Sensing range (mm in) (Note 1, 2, 3)				Beam axis position / Inclination of beam axis	Protection	Ambient temp.
					FX-500 series	Other modes	U-LG LONG FAST H-SP	FX-550 / FX-550L series			
Reflective Threaded	M3	 Tough (Bending durability)	R2	2 m	STD 125 4.921 HYPR 515 20.276	290 11.417 220 8.661 80 3.150 25 0.984	200 7.874 HYPR 750 29.528	450 17.717 310 12.205 140 5.512	150 μm ±3°	IP67	-55 to +80 °C
		 Tough (Bending durability)	R1		STD 80 3.150 HYPR 330 12.992	180 7.087 140 5.512 45 1.772 12 0.472	130 5.118 HYPR 480 18.898	310 12.205 190 7.480 80 3.150			
		 Tough (Bending durability)	R2		STD 200 7.874 HYPR 650 25.591	380 14.961 270 10.630 95 3.740 27 1.063	STD 320 12.598 HYPR 1,150 45.278	730 28.740 420 16.535 170 6.693		-55 to +80 °C	
		 Tough (Bending durability)	R2		STD 200 7.874 HYPR 630 24.803	410 16.142 360 14.173 100 3.937 30 1.181	STD 320 12.598 HYPR 1,350 53.150	730 28.740 490 19.291 180 7.087			-55 to +80 °C
		 Tough (Bending durability)	R2		STD 90 3.543 HYPR 330 12.992	185 7.283 135 5.305 49 1.929 15 0.591	130 5.118 HYPR 480 18.898	310 12.205 180 7.087 80 3.150		-40 to +70 °C	
		 Tough (Bending durability)	R4		STD 48 1.890 HYPR 170 6.693	130 5.118 110 4.331 30 1.181 9 0.354	STD 90 3.543 HYPR 320 12.598	190 7.480 120 4.724 50 1.969			-20 to +60 °C
	 Tough (Bending durability)	R4	STD 20 0.787 HYPR 85 3.346	45 1.772 35 1.378 12 0.472 3.5 0.138	STD 35 1.378 HYPR 120 4.724	70 2.756 45 1.772 20 0.787	-20 to +60 °C				
	M4	 Tough (Bending durability)	R2	2 m	STD 125 4.921 HYPR 515 20.276	290 11.417 220 8.661 80 3.150 25 0.984		200 7.874 HYPR 750 29.528	450 17.717 310 12.205 140 5.512	150 μm ±3°	IP67
		 Tough (Bending durability)	R1		STD 270 10.630 HYPR 900 35.433	630 24.803 430 16.929 150 5.906 45 1.772	STD 480 18.898 HYPR 1,400 55.118	1,000 39.370 680 26.772 270 10.630	-40 to +60 °C		
		 Tough (Bending durability)	R2		STD 200 7.874 HYPR 650 25.591	380 14.961 270 10.630 95 3.740 27 1.063	STD 320 12.598 HYPR 1,150 45.278	730 28.740 420 16.535 170 6.693		-55 to +80 °C	
		 Tough (Bending durability)	R1		STD 150 5.906 HYPR 670 26.378	340 13.386 280 11.024 90 3.543 25 0.984	STD 210 8.268 HYPR 950 37.402	540 21.260 330 12.992 130 5.118	-40 to +60 °C		
	M6	 (Bending durability)	R4	2 m	STD 520 20.472 HYPR 1,500 59.055	1,000 39.370 940 37.008 340 13.386 110 4.331	STD 880 34.646 HYPR 1,950 76.772	1,450 57.087 1,140 44.882 550 21.654		150 μm ±3°	IP67
		 Tough (Bending durability)	R1		STD 450 17.717 HYPR 1,400 55.118	840 33.071 670 26.378 200 7.874 70 2.756	STD 620 24.409 HYPR 1,630 64.173	1,180 46.457 870 34.252 380 14.961	-40 to +60 °C		
		 Tough (Bending durability)	R1		STD 270 10.630 HYPR 900 35.433	630 24.803 430 16.929 150 5.906 45 1.772	STD 480 18.898 HYPR 1,400 55.118	1,000 39.370 680 26.772 270 10.630		-40 to +60 °C	
		 Tough (Bending durability)	R4		STD 420 16.535 HYPR 1,100 43.307	800 31.496 650 25.591 200 7.874 60 2.362	STD 600 23.622 HYPR 1,350 53.150	1,200 47.244 850 33.465 350 13.780	-55 to +80 °C		
		 Tough (Bending durability)	R4		STD 280 11.024 HYPR 670 26.378	500 19.685 410 16.142 160 6.299 50 1.969	STD 410 16.142 HYPR 1,200 47.244	700 27.559 590 23.228 230 9.055		-55 to +80 °C	
 Tough (Bending durability)		R4	STD 290 11.417 HYPR 1,100 43.307		600 23.622 550 21.654 190 7.480 65 2.559	STD 500 19.685 HYPR 1,450 57.087	1,150 45.276 800 31.496 350 13.780	150 μm ±3°	IP67		-55 to +80 °C
Elbow	 Tough (Bending durability)	R4	2 m	STD 290 11.417 HYPR 1,100 43.307	600 23.622 550 21.654 190 7.480 65 2.559	STD 500 19.685 HYPR 1,450 57.087	1,150 45.276 800 31.496 350 13.780			150 μm ±3°	







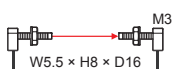
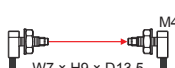
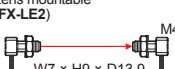

- Notes: 1) Note that the sensing range of the free-cut type fiber may be reduced by 20 % max. depending upon how the fiber is cut.
 2) The sensing range is specified for white non-glossy paper.
 3) The **FX-550L** series does not have FAST mode.
 4) The allowable cutting range is 700 mm **27.559 in** from the end that the amplifier inserted.

Tough : Refer to a fiber which possesses both unbreakable (bending radius: R10 mm **R0.394 in**, reciprocating bending: 180°) and more flexible (bending radius: R4 mm **R0.157 in** or less) features.
Bending durability : Refer to a fiber which possesses unbreakable bending-resistant feature (bending radius: R10 mm **R0.394 in**, reciprocating bending: 180°).

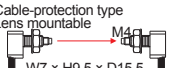
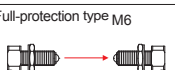
LIST OF FIBERS

Square head type

*Thru-beam type sensors are available as two pieces per set.

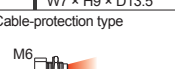
Type	Shape of fiber head (mm)	Model No.	Bending radius (mm)	Fiber cable length Free-cut	Sensing range (mm in) (Note 1, 3, 4)				Beam axis dia. (Fiber Core) (mm)	Protection	Ambient temp.	
					FX-500 series		FX-550 / FX-550L series					
				Other modes		U-LG LONG FAST H-SP		Other modes		U-LG LONG FAST		
Thru-beam	Square head	 W5.5 × H8 × D16 M3	Tough <small>Bending durability</small> FT-R31	R2	2 m	STD	580 22.835	STD	1,120 44.094	ø0.5	IP67	-55 to +80 °C
						HYPR 1,000 39.370	440 17.323 160 6.299 55 2.165	510 20.079 700 27.559 310 12.205				
		 W7 × H9 × D13.5 M4	Tough <small>Bending durability</small> FT-R43	R4	2 m	STD	1,600 62.992	STD	2,650 104.331	ø1	IP40	-40 to +60 °C
						HYPR 3,000 118.110	1,100 43.307 430 16.929 130 5.118	1,250 49.213 1,750 68.898 750 29.528				
		 W7 × H9 × D13.9 M4	FT-R41W	R1	2 m	STD	1,800 70.866	STD	2,900 114.173	ø1	IP40	-40 to +60 °C
						HYPR 3,200 125.984	1,400 55.118 460 18.110 150 5.906	1,300 51.181 3,600 141.732 (Note 2)				
 W7 × H9 × D14.4 M4	FT-R42W	R1	2 m	STD	3,600 141.732 (Note 2)	STD	3,600 141.732 (Note 2)	ø2.2	IP40	-40 to +60 °C		
				HYPR 3,600 141.732 (Note 2)	3,500 137.795 1,300 51.181 460 18.110	3,600 141.732 (Note 2) 3,600 141.732 (Note 2) 2,800 110.236						
 W7 × H9.5 × D15.5 M4	Tough <small>Bending durability</small> FT-R44Y	R4	2 m	STD	1,600 62.992	STD	2,900 114.173	ø1	IP67 (Note 5)	-55 to +80 °C		
				HYPR 3,000 118.110	1,100 43.307 430 16.929 130 5.118	1,300 51.181 3,600 141.732 (Note 2)						
 W10 × H11 × D21.2 M6	Tough <small>Bending durability</small> FT-R60Y	R4	2 m	STD	3,600 141.732 (Note 2)	STD	3,600 141.732 (Note 2)	ø3.5	IP68G	-55 to +80 °C		
				HYPR 3,600 141.732 (Note 2)	3,500 137.795 1,300 51.181 460 18.110	3,600 141.732 (Note 2) 3,600 141.732 (Note 2) 1,900 74.803						
Reflective	Square head	 W5.5 × H8 × D16 M3	Tough <small>Bending durability</small> FD-R31G	R2	2 m	STD	310 12.205	STD	600 23.622	Emitter ø0.5	IP40	-55 to +80 °C
						HYPR 530 20.866	260 10.236 85 3.346 27 1.063	290 11.417 400 15.748 160 6.299				
		 W5.5 × H8 × D16 M3	FD-R32EG	R4	500mm	STD	110 4.331	STD	180 7.087	Emitter ø0.25	IP40	-40 to +70 °C
						HYPR 170 6.693	92 3.622 30 1.181 9 0.354	80 3.150 110 4.331 45 1.772				
		 W5.5 × H8 × D16 M3	FD-R34EG	R4	500mm	STD	90 3.543	STD	140 5.512	Emitter ø0.175	IP40	-20 to +60 °C
						HYPR 130 5.118	70 2.756 23 0.906 7 0.276	70 2.756 250 9.843				
 W5.5 × H8 × D16 M3	FD-R33EG	R4	500mm	STD	44 1.732	STD	65 2.559	Emitter ø0.125	IP40	-20 to +60 °C		
				HYPR 84 3.307	33 1.299 11 0.433 3 0.118	30 1.181 110 4.331						
 W7 × H9 × D13.5 M4	Tough <small>Bending durability</small> FD-R41	R2	2 m	STD	430 16.929	STD	750 29.528	ø0.75	IP67	-55 to +80 °C		
				HYPR 710 27.953	320 12.598 100 3.937 34 1.339	340 13.386 1,150 45.276						
 W10 × H11 × D15.5 M6	Tough <small>Bending durability</small> FD-R61Y	R4	2 m	STD	610 24.016	STD	1,000 39.370	—	IP67 (Note 5)	-55 to +80 °C		
				HYPR 990 38.976	435 17.126 160 6.299 50 1.969	450 17.717 1,350 53.150						

- Notes: 1) Note that the sensing range of the free-cut type fiber may be reduced by 20 % max. depending upon how the fiber is cut.
 2) The fiber cable length practically limits the sensing range.
 3) The **FX-550L** series does not have FAST mode.
 4) The sensing range of reflective type is specified for white non-glossy paper.
 5) The fiber part is oil-resistant.

Tough : Refer to a fiber which possesses both unbreakable (bending radius: R10 mm **R0.394 in**, reciprocating bending: 180°) and more flexible (bending radius: R4 mm **R0.157 in** or less) features.
Bending durability : Refer to a fiber which possesses unbreakable bending-resistant feature (bending radius: R10 mm **R0.394 in**, reciprocating bending: 180°).

LIST OF FIBERS

Cylindrical type

*Thru-beam type sensors are available as two pieces per set.

Type	Shape of fiber head (mm)	Model No.	Bending radius (mm)	Fiber cable length (m) : Free-cut	Sensing range (mm in) (Note 1, 3, 4)				Beam axis dia. (mm)	Beam axis position / Inclination of beam axis	Protection	Ambient temp.
					FX-500 series	Other modes	U-LG LONG FAST H-SP	FX-550 / FX-550L series				
Thru-beam Cylindrical		Tough (Bending durability) FT-S11	R2	500 mm	STD 90 3.543	210 8.268	STD 130 5.118	280 11.024	0.25	—	IP67	-55 to +80 °C
		HYPR 350 13.780			160 6.299	HYPR 180 7.867	180 7.867					
		Tough (Bending durability) FT-S21	R1	2 m	STD 315 12.402	770 30.315	STD 450 17.717	1,000 39.370	0.5	150 μm / ±2°	IP67	-40 to +60 °C
		HYPR 1,350 53.150			550 21.654	HYPR 670 26.378	670 26.378					
		FT-S21W	R1	2 m	STD 260 10.236	590 23.228	STD 400 15.748	850 33.465	0.5	150 μm / ±3°	IP67	-40 to +60 °C
		HYPR 990 38.976			440 17.323	HYPR 150 5.906	580 22.835					
		Tough (Bending durability) FT-S22	R10	2 m	STD 450 17.717	920 36.220	STD 870 34.252	1,900 74.803	0.7	—	IP40	-40 to +70 °C
		HYPR 1,500 59.055			730 28.740	HYPR 250 9.843	1,200 47.244					
		(Bending durability) FT-S32	R10	2 m	STD 3,100 122.047	3,600 141.732 (Note 2)	STD 3,600 141.732 (Note 2)	3,600 141.732 (Note 2)	2	—	IP40	-40 to +70 °C
		HYPR (Note 2) 3,600 141.732			3,600 141.732 (Note 2)	3,600 141.732 (Note 2)	3,600 141.732 (Note 2)					
	FT-S31W	R1	2 m	STD 800 31.496	1,900 74.803	STD 1,100 43.307	2,450 96.457	1	150 μm / ±3°	IP67	-40 to +60 °C	
	HYPR 3,300 129.921			1,400 55.118	HYPR 1,600 62.992	1,600 62.992						
Ultra-small diameter		Tough (Bending durability) FT-E13	R2	1 m	STD 15 0.591	30 1.181	STD 21 0.827	45 1.772	0.125	—	IP67	-40 to +70 °C
		HYPR 52 2.047			24 0.945	HYPR 8 0.315	30 1.181					
Ultra-small diameter		Tough (Bending durability) FT-E23	R2	1 m	STD 75 2.953	160 6.299	STD 120 4.724	250 9.843	0.25	—	IP67	-40 to +70 °C
		HYPR 270 10.630			125 4.921	HYPR 42 1.654	165 6.496					
Side-view		Tough (Bending durability) FT-V40	R4	2 m	STD 3,500 137.795	3,600 141.732 (Note 2)	STD 3,600 141.732 (Note 2)	3,600 141.732 (Note 2)	2.5	—	IP50	-40 to +60 °C
Reflective Cylindrical		Tough (Bending durability) FD-S21	R2	1 m	STD 80 3.150	130 5.118	STD 85 3.346	130 5.118	—	IP40	-55 to +80 °C	
		HYPR 190 7.480			110 4.331	HYPR 37 1.457	110 4.331					
		Tough (Bending durability) FD-S32	R4	2 m	STD 420 16.535	790 31.102	STD 600 23.622	1,200 42.244	150 μm / ±3°	IP67	-40 to +60 °C	
		HYPR 1,200 47.244			660 25.984	HYPR 220 8.661	900 35.433					
		FD-S32W	R1	2 m	STD 270 10.630	630 24.803	STD 450 17.717	1,000 39.370	150 μm / ±3°	IP67	-40 to +60 °C	
		HYPR 900 35.433			430 16.929	HYPR 150 5.906	650 25.991					
		Tough (Bending durability) FD-S31	R2	2 m	STD 125 4.921	290 11.417	STD 200 7.874	450 17.717	150 μm / ±3°	IP67	-55 to +80 °C	
		HYPR 515 20.276			220 8.661	HYPR 80 3.150	300 11.811					
Coaxial		FD-S33GW	R1	2 m	STD 150 5.906	340 13.386	STD 240 9.449	550 21.654	150 μm / ±3°	IP67	-40 to +60 °C	
		HYPR 670 26.378			280 11.024	HYPR 90 3.543	370 14.567					
Coaxial, With lens		Tough (Bending durability) FD-S34G	R2	2 m	STD 90 3.543	185 7.283	STD 130 5.118	310 12.205	150 μm / ±3°	IP67	-40 to +70 °C	
		HYPR 330 12.992			135 5.305	HYPR 49 1.929	180 7.187					
Ultra-small diameter		FD-E13	R4	1 m	STD 12 0.472	29 1.142	STD 23 0.906	50 1.969	150 μm / ±3°	IP67	-40 to +60 °C	
		HYPR 150 1.969			25 0.984	HYPR 7 0.276	30 1.181					
Ultra-small diameter		FD-E23	R4	1 m	STD 55 2.165	120 4.724	STD 80 3.150	170 6.693	150 μm / ±3°	IP67	-40 to +70 °C	
		HYPR 170 6.693			80 3.150	HYPR 30 1.181	105 4.134					

- Notes: 1) Note that the sensing range of the free-cut type fiber may be reduced by 20 % max. depending upon how the fiber is cut.
 2) The fiber cable length practically limits the sensing range.
 3) The FX-550L series does not have FAST mode.
 4) The sensing range of reflective type is specified for white non-glossy paper.

Tough : Refer to a fiber which possesses both unbreakable (bending radius: R10 mm **R0.394 in**, reciprocating bending: 180°) and more flexible (bending radius: R4 mm **R0.157 in** or less) features.
Bending durability : Refer to a fiber which possesses unbreakable bending-resistant feature (bending radius: R10 mm **R0.394 in**, reciprocating bending: 180°).

LIST OF FIBERS

Sleeve type

*Thru-beam type sensors are available as two pieces per set.

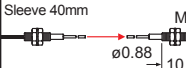
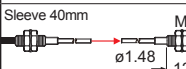
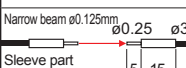
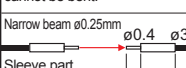
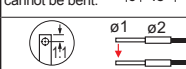
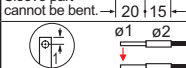
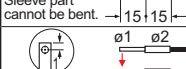
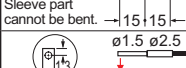
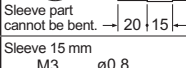
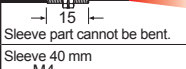
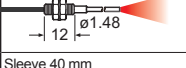
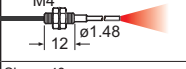
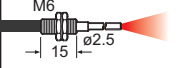
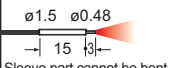
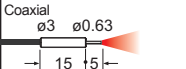
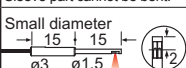
Type	Shape of fiber head (mm)	Model No.	Bending radius (mm)	Fiber cable length : Free-cut	Sensing range (mm in) (Note 1, 4, 5)				Beam axis dia. (mm)	Protection	Ambient temp.			
					FX-500 series		FX-550 / FX-550L series							
Thru-beam	Threaded	M3 	Tough (Bending durability) FT-31S	R2 (Note 2)	2 m	STD 315 12.402 HYPR 1,220 48.031	740 29.134 550 21.654 195 7.677 63 2.480	STD 480 18.898 HYPR 1,580 62.205	1,000 39.370 700 27.559 290 11.417	∅0.5	IP67	-55 to +80 °C		
		M4 	Tough (Bending durability) FT-42S	R4 (Note 2)	2 m	STD 1,130 44.488 HYPR (Note 3) 3,600 141.732	2,050 80.709 1,600 62.992 530 20.866 190 7.480	STD 1,470 57.874 HYPR 3,600 141.732 (Note 3)	2,900 114.173 2,100 82.677 890 35.039	∅1				
	Cylindrical	Ultra-small diameter	∅3 	Tough (Bending durability) FT-E13	R2	1 m	STD 15 0.591 HYPR 152 2.047	30 1.181 24 0.945 8 0.315 2 0.079	STD 21 0.827 HYPR 68 2.677	45 1.772 30 1.181 12 0.472	∅0.125	IP67	-40 to +70 °C	
			∅3 	Tough (Bending durability) FT-E23	R2	1 m	STD 75 2.953 HYPR 270 10.630	160 6.299 125 4.921 42 1.654 13 0.512	STD 120 4.724 HYPR 355 13.976	250 9.843 165 6.496 70 2.756	∅0.25			
		Side-view	∅2		Tough (Bending durability) FT-V23	R4	2 m	STD 450 17.717 HYPR 1,800 70.866	1,000 39.370 880 34.646 280 11.024 90 3.543	STD 750 29.528 HYPR 2,400 94.488	1,600 62.992 1,050 41.339 450 17.717	∅0.75	IP30	-55 to +80 °C
					Tough (Bending durability) FT-V25	R2	2 m	STD 240 9.449 HYPR 900 35.433	550 21.654 480 18.898 140 5.512 45 1.772	STD 450 17.717 HYPR 1,400 55.118	950 37.402 630 24.803 280 11.024	∅0.5		
				FT-V24W	R1	2 m	STD 110 4.331 HYPR 380 14.961	230 9.055 200 7.874 60 2.362 20 0.787	STD 160 6.299 HYPR 500 19.685	350 13.780 220 8.661 95 3.740	∅1.0			
	Reflective	Threaded	Ultra-small diameter M3 	FD-EG30S	R4	1 m	STD 50 1.969 HYPR 170 6.693	110 4.331 80 3.150 30 1.181 9 0.354	STD 90 3.543 HYPR 320 12.598	190 7.480 120 4.724 50 1.969	∅0.5	IP40	-40 to +70 °C	
			M4 	FD-41S	R2 (Note 2)	2 m	STD 125 4.921 HYPR 515 20.276	290 11.417 220 8.661 80 3.150 25 0.984	STD 200 7.874 HYPR 750 29.528	450 17.717 310 12.205 140 5.512	∅0.5			
			M4 	FD-41SW	R1 (Note 2)	2 m	STD 80 3.150 HYPR 330 12.992	180 7.087 140 5.512 45 1.772 12 0.472	STD 130 5.118 HYPR 480 18.898	310 12.205 190 7.480 80 3.150	∅0.5			
M6 			FD-61S	R4 (Note 2)	2 m	STD 420 16.535 HYPR 1,200 47.244	790 31.102 680 25.984 220 8.661 75 2.953	STD 650 25.591 HYPR 1,900 74.803	1,300 51.181 900 35.433 400 15.748	∅1.0				
Cylindrical		Ultra-small diameter	∅1.5 	FD-E13	R4	1 m	STD 12 0.472 HYPR 50 1.969	29 1.142 25 0.984 7 0.276 2 0.079	STD 23 0.906 HYPR 75 2.953	50 1.969 30 1.181 12 0.472	∅0.5	IP40	-40 to +70 °C	
			Coaxial ∅3 	FD-E23	R4	1 m	STD 55 2.165 HYPR 170 6.693	120 4.724 80 3.150 30 1.181 9 0.354	STD 80 3.150 HYPR 290 11.417	170 6.693 105 4.134 45 1.772	∅0.5			
		Side-view	∅3		FD-V30	R2	2 m	STD 65 2.559 HYPR 240 9.449	130 5.118 120 4.724 35 1.378 14 0.551	STD 90 3.243 HYPR 430 16.929	210 8.268 145 5.709 65 2.559	∅0.5	IP30	-55 to +80 °C
					FD-V30W	R1	2 m	STD 20 0.787 HYPR 80 3.150	40 1.575 30 1.181 10 0.394 2 0.079	STD 30 1.181 HYPR 120 4.724	65 2.559 37 1.457 16 0.630	∅0.5		
			∅5 	FD-V50	R4	2 m	STD 120 4.724 HYPR 370 14.567	220 8.661 210 8.268 75 2.953 25 0.984	STD 180 7.087 HYPR 530 20.866	400 15.748 240 9.449 110 4.331	∅1.0			

- Notes: 1) Note that the sensing range of the free-cut type fiber may be reduced by 20 % max. depending upon how the fiber is cut.
 2) Bending radius of sleeve part is R10 mm **R0.394 in** or more.
 3) The fiber cable length practically limits the sensing range.
 4) The **FX-550L** series does not have FAST mode.
 5) The sensing range of reflective type is specified for white non-glossy paper.

Tough : Refer to a fiber which possesses both unbreakable (bending radius: R10 mm **R0.394 in**, reciprocating bending: 180°) and more flexible (bending radius: R4 mm **R0.157 in** or less) features.
Bending durability : Refer to a fiber which possesses unbreakable bending-resistant feature (bending radius: R10 mm **R0.394 in**, reciprocating bending: 180°).

LIST OF FIBERS

Flat type

*Thru-beam type sensors are available as two pieces per set.







Type	Shape of fiber head (mm)	Model No.	Bending radius (mm)	Fiber cable length Free-cut	Sensing range (mm in) (Note 1, 3, 4)				Beam axis dia. (mm)	Protection	Ambient temp.			
					FX-500 series	Other modes	U-LG LONG FAST H-SP	FX-550 / FX-550L series				Other modes	U-LG LONG FAST	
Thru-beam	Flat	Tough (Bending durability) FT-Z30H	R2	2 m	STD 3,600 141.732 (Note 2)	3,600 141.732 (Note 2)	3,600 141.732 (Note 2)	3,600 141.732 (Note 2)	2 x 3	IP40	-40 to +60 °C			
		FT-Z30HW	R1		HYPR (Note 2) 3,600 141.732							3,600 141.732 (Note 2)	3,600 141.732 (Note 2)	3,600 141.732 (Note 2)
		Tough (Bending durability) FT-Z30E	R2		STD 3,500 137.795							3,600 141.732 (Note 2)	3,600 141.732 (Note 2)	3,600 141.732 (Note 2)
		FT-Z30EW	R1		HYPR (Note 2) 3,600 141.732							3,600 141.732 (Note 2)	3,600 141.732 (Note 2)	3,600 141.732 (Note 2)
		Tough (Bending durability) FT-Z30	R2		STD 2,100 82.677							3,600 141.732 (Note 2)	3,600 141.732 (Note 2)	3,600 141.732 (Note 2)
		FT-Z30W			HYPR (Note 2) 3,600 141.732							3,600 141.732 (Note 2)	3,600 141.732 (Note 2)	3,600 141.732 (Note 2)
	With boss	FT-Z20W	R1	1 m	STD 620 24.409	1,500 59.055	1,100 43.307	1,600 62.992 (Note 2)	ø1.5	IP67				
		FT-Z20HBW			HYPR (Note 2) 1,600 62.992	3,200 125.984	420 16.535	1,600 62.992 (Note 2)						
		FT-Z40W			STD 800 31.496	3,300 129.921	2,000 78.740	3,600 141.732 (Note 2)						
		FT-Z40HBW			HYPR 3,300 129.921	3,200 125.984	900 35.433	3,600 141.732 (Note 2)						
		FT-Z40W			STD 1,500 59.055	3,300 129.921	2,000 78.740	3,600 141.732 (Note 2)						
		FT-Z40HBW			HYPR 3,300 129.921	3,200 125.984	900 35.433	3,600 141.732 (Note 2)						
Chemical-resistant	Tough (Bending durability) FT-Z802Y	R4		STD 3,100 122.047	3,600 141.732 (Note 2)	3,600 141.732 (Note 2)	3,600 141.732 (Note 2)	ø3.7	IP68G	0 to +60 °C				
Reflective	Flat	FD-Z20W	R1	1 m	STD 1 to 65 0.039 to 2.559	150 5.906	STD 130 5.118	290 11.417	IP40					
		FD-Z20HBW			HYPR 260 10.236	390 15.354	HYPR 450 17.717	190 7.480						
		FD-Z40W			STD 1 to 85 0.079 to 3.346	1 to 210 0.039 to 8.268	170 6.693	370 14.567						
		FD-Z40HBW			HYPR 1 to 340 0.039 to 13.386	1 to 180 0.039 to 7.087	HYPR 550 21.254	240 9.449						
	With boss	FD-Z40W	R1	2 m	STD 190 7.480	390 15.354	390 15.254	950 37.402	IP40					
		FD-Z40HBW			HYPR 790 31.102	1 to 120 0.039 to 4.724	1,500 59.155	510 20.079						
		FD-Z40W			STD 260 10.236	2 to 35 0.079 to 1.378	480 18.898	230 9.055						
		FD-Z40HBW			HYPR 760 29.921	1 to 160 0.039 to 6.299	1,350 53.150	680 26.772						

- Notes: 1) Note that the sensing range of the free-cut type fiber may be reduced by 20 % max. depending upon how the fiber is cut.
 2) The fiber cable length practically limits the sensing range.
 3) The **FX-550L** series does not have FAST mode.
 4) The sensing range of reflective type is specified for white non-glossy paper.
 5) The design takes into account the environmental testing required by SEMI S2. To ensure that the final system complies with the standards, you must design and use it in accordance with relevant standards, regulations, and regulations.

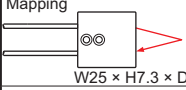
Tough : Refer to a fiber which possesses both unbreakable (bending radius: R10 mm **R0.394 in**, reciprocating bending: 180°) and more flexible (bending radius: R4 mm **R0.157 in** or less) features.
 Bending durability : Refer to a fiber which possesses unbreakable bending-resistant feature (bending radius: R10 mm **R0.394 in**, reciprocating bending: 180°).

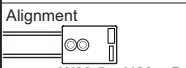
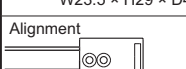
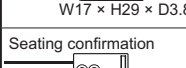
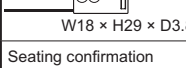
LIST OF FIBERS

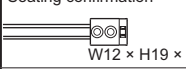
Convergent reflective type

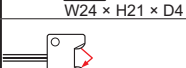
Type	Shape of fiber head (mm)	Model No.	Bending radius (mm)	Fiber cable length Free-cut	Sensing range (mm in) (Note 1, 2, 3)				Protection	Ambient temp.
					FX-500 series	Other modes	U-LG LONG FAST H-SP	FX-550 / FX-550L series		
Convergent reflective	Glass substrate detection	 Mapping W25 × H7.3 × D30 FD-L32H Bending durability, R4	4 m	STD 0 to 56 0 to 2.205 HYPR 0 to 110 0 to 4.331	0 to 87 0 to 3.425 0 to 74 0 to 2.913 1 to 38 0.039 to 1.496 Cannot use	STD 0 to 65 0 to 2.559 HYPR 0 to 100 0 to 3.397	0 to 90 0 to 3.543 0 to 75 0 to 2.953 0 to 50 0 to 1.969	IP40	-40 to +60 °C	
		 Alignment W20 × H29 × D3.8 FD-L30A Tough, Bending durability, R2	3 m	STD 0 to 43 0 to 1.693 HYPR 0 to 43 0 to 1.693	0 to 43 0 to 1.693 0 to 43 0 to 1.693 0 to 42 0 to 1.654 0 to 29 0 to 1.142	STD 0 to 52 0 to 2.047 HYPR 0 to 72 0 to 2.835	0 to 68 0 to 2.677 0 to 62 0 to 2.441 0 to 46 0 to 1.811			
		 Alignment W23.5 × H29 × D4.5 FD-L31A Tough, Bending durability, R4	3 m	STD 4 to 33 0.157 to 1.299 HYPR 3 to 35 0.118 to 1.378	4 to 33 0.157 to 1.299 4 to 33 0.157 to 1.299 4 to 32 0.157 to 1.260 5 to 25 0.197 to 0.984	STD 3 to 42 0.118 to 1.654 HYPR 0 to 50 0 to 1.967	2 to 43 0.079 to 1.693 3 to 42 0.118 to 1.654 3 to 40 0.118 to 1.575			
		 Alignment W17 × H29 × D3.8 FD-L22A Tough, Bending durability, R2	2 m	STD 0 to 24 0 to 0.945 HYPR 0 to 31 0 to 1.220	0 to 28 0 to 1.102 0 to 27 0 to 1.063 0 to 24 0 to 0.945 0 to 18 0 to 0.709	STD 0 to 34 0 to 1.339 HYPR 0 to 35 0 to 1.378	0 to 35 0 to 1.378 0 to 35 0 to 1.378 0 to 32 0 to 1.260			
		 Seating confirmation W18 × H29 × D3.8 FD-L23 Tough, Bending durability, R2	3 m	STD 0 to 29 0 to 1.142 HYPR 0 to 30 0 to 1.181	0 to 30 0 to 1.181 0 to 30 0 to 1.181 0 to 28 0 to 1.102 1.5 to 24 0.059 to 0.945	STD 0 to 34 0 to 1.339 HYPR 0 to 34 0 to 1.339	0 to 34 0 to 1.339 0 to 34 0 to 1.339 0 to 32 0 to 1.260			
		 Seating confirmation W12 × H19 × D3 FD-L11 Tough, Bending durability, R4	3 m	STD 0 to 9.5 0 to 0.374 HYPR 0 to 11.5 0 to 0.453	0 to 10.5 0 to 0.413 0 to 10 0 to 0.394 0 to 9 0 to 0.354 0 to 8 0 to 0.315	STD 0 to 13 0 to 0.512 HYPR 0 to 14 0 to 0.551	0 to 13 0 to 0.512 0 to 13 0 to 0.512 0 to 12 0 to 0.472			
		 Seating confirmation W12 × H19 × D3 FD-L10 Tough, Bending durability, R4	3 m	STD 0 to 5 0 to 0.197 HYPR 0 to 6 0 to 0.236	0 to 5.5 0 to 0.217 0 to 5.5 0 to 0.217 0 to 4.5 0 to 0.177 0 to 4 0 to 0.157	STD 0 to 5 0 to 0.197 HYPR 0 to 6 0 to 0.236	0 to 5.5 0 to 0.217 0 to 5.5 0 to 0.217 0 to 5 0 to 0.197			
		 Seating confirmation W24 × H21 × D4 FD-L21 Tough, Bending durability, R2	2 m	STD 1.5 to 16 0.059 to 0.630 HYPR 1.5 to 19 0.039 to 0.748	1 to 18 0.039 to 0.709 1 to 18 0.039 to 0.709 2 to 15 0.079 to 0.591 3 to 12 0.118 to 0.472	STD 1 to 19 0.039 to 0.748 HYPR 1 to 20 0.039 to 0.787	1 to 20 0.039 to 0.787 1 to 19 0.039 to 0.748 2 to 18 0.079 to 0.709			
		 Seating confirmation W24 × H21 × D4 FD-L21W R1	2 m	STD 3 to 14 0.118 to 0.551 HYPR 1.5 to 15 0.059 to 0.591	2 to 15 0.079 to 0.591 2 to 15 0.079 to 0.591 4 to 14 0.157 to 0.551 6.5 to 10 0.256 to 0.394	STD 2 to 18 0.079 to 0.709 HYPR 1 to 19 0.039 to 0.748	1 to 19 0.039 to 0.748 2 to 18 0.079 to 0.709 3 to 17 0.118 to 0.669			
		 General purpose W6 × H18 × D14 FD-L20H Tough, Bending durability, R2	3 m	STD 0 to 23 0 to 0.906 HYPR 0 to 45 0 to 1.772	0 to 35 0 to 1.378 0 to 32 0 to 1.260 2 to 15 0.079 to 0.591 5 to 9 0.197 to 0.354	STD 0 to 33 0 to 1.229 HYPR 0 to 65 0 to 2.559	0 to 50 0 to 1.969 0 to 40 0 to 1.575 0 to 25 0 to 0.984			
 Ultra-small W7.2 × H7.5 × D2 FD-L12W R1	1 m	STD 0 to 8 0 to 0.315 HYPR 0 to 14 0 to 0.551	0 to 12.5 0 to 0.492 0 to 12 0 to 0.472 0.5 to 7 0.020 to 0.276 0.5 to 4 0.020 to 0.157	STD 0 to 12 0 to 0.472 HYPR 0 to 17 0 to 0.669	0 to 16 0 to 0.630 0 to 15 0 to 0.591 0 to 10 0 to 0.394					

- Notes: 1) Note that the sensing range of the free-cut type fiber may be reduced by 20 % max. depending upon how the fiber is cut.
 2) The sensing range is specified for transparent glass 100 × 100 × t0.7 mm 3.937 × 3.937 × t0.028 in (FD-L32H: R edge, FD-L21 and FD-L21W: t2 mm t0.079 in) (FD-L20H: white non-glossy paper, FD-L10: silicon wafers 100 × 100 mm 3.937 × 3.937 in).
 3) The FX-550L series does not have FAST mode.

Tough : Refer to a fiber which possesses both unbreakable (bending radius: R10 mm **R0.394 in**, reciprocating bending: 180°) and more flexible (bending radius: R4 mm **R0.157 in** or less) features.
Bending durability : Refer to a fiber which possesses unbreakable bending-resistant feature (bending radius: R10 mm **R0.394 in**, reciprocating bending: 180°).

LIST OF FIBERS

Small spot

Reflective type fiber & spot lens

Designation	Shape of head (mm)	Spot diameter (mm in) (Note 1)	Sensing range (mm in) (Note 1)	Lens		Applicable fibers					
				Model No.	Ambient temp.	Model No.	Fiber cable length ✂: Free-cut (Note 2)	Bending radius (mm)	Protection	Ambient temp.	
Finest spot lens		ø0.1 ø 0.004 approx.	Distance to focal point 7 ±0.5 0.276 ±0.020	FX-MR7	-55 to +70 °C	FD-R33EG	500 mm	R4	IP40		
						FD-EG31					
		FD-R34EG									
		FD-R32EG									
		FD-EG30				✂	2 m	Tough Bending durability FD-R31G			R2
		Tough Bending durability FD-42G						R1			
		FD-42GW						R2			
		Tough Bending durability FD-32G									
		ø0.15 ø 0.006 approx.				FD-32GX	✂ 1 m (Note 3)				
						ø0.2 ø 0.008 approx.					
		ø0.1 ø 0.004 approx.	Distance to focal point 7 ±0.5 0.276 ±0.020	FX-MR6	-20 to +60 °C	FD-R33EG	500mm	R4			
						FD-EG31					
		FD-R34EG									
		FD-R32EG									
		FD-EG30				✂	2m	Tough Bending durability FD-R31G			R2
		Tough Bending durability FD-42G						R1			
		FD-42GW						R2			
		Tough Bending durability FD-32G									
		ø0.15 ø 0.006 approx.				FD-32GX	✂ 1m (Note 3)				
						ø0.2 ø 0.008 approx.					
	ø0.4 ø 0.016 approx.										

Notes: 1) Spot diameter, sensing range and distance to focal point are specified for **FX-500 / FX-550 / FX-550L** series.
 2) Note that the sensing range of the free-cut type fiber may be reduced by 20 % max. depending upon how the fiber is cut.
 3) The allowable cutting range is 700 mm **27.559 in** from the end that the amplifier inserted.

Tough : Refer to a fiber which possesses both unbreakable (bending radius: R10 mm R0.394 in, reciprocating bending: 180°) and more flexible (bending radius: R4 mm R0.157 in or less) features.
Bending durability : Refer to a fiber which possesses unbreakable bending-resistant feature (bending radius: R10 mm R0.394 in, reciprocating bending: 180°).

LIST OF FIBERS

Small spot

Reflective type fiber & spot lens

Designation	Shape of head (mm)	Spot diameter (mm in) (Note 1)	Sensing range (mm in) (Note 1)	Lens		Applicable fibers					
				Model No.	Ambient temp.	Model No.	Fiber cable length : Free-cut (Note 2)	Bending radius (mm)	Protection	Ambient temp.	
Finest spot lens		ø0.15 ø0.006 approx.	Distance to focal point 7.5 ±0.5 0.295 ±0.020	FX-MR3	-40 to +70 °C	FD-R33EG	500mm	R4	IP40	-20 to +60 °C	
						FD-EG31					
		FD-R34EG									
		FD-R32EG									
		ø0.2 ø0.008 approx.				FD-EG30	2m	R2			-40 to +70 °C
						Tough FD-R31G					
		ø0.3 ø0.012 approx.				Tough FD-42G	2m	R1			-55 to +80 °C
						FD-42GW					
	ø0.5 ø0.020 approx.	Tough FD-32G	1m (Note 3)	R2	-40 to +60 °C						
		FD-32GX									
Zoom lens		ø0.4 to ø2.0 ø0.016 to ø0.079 approx.	10 to 30 0.394 to 1.181	FX-MR8	-55 to +70 °C	FD-R33EG	500 mm	R4	IP40	-20 to +60 °C	
						FD-EG31					
		FD-R34EG									
		FD-R32EG									
		ø0.4 to ø2.2 ø0.016 to ø0.087 approx.				FD-EG30	2 m	R2			-40 to +70 °C
						Tough FD-R31G					
		ø0.5 to ø2.5 ø0.020 to ø0.098 approx.				Tough FD-32G	1 m (Note 3)	R2			-55 to +80 °C
						FD-32GX					
	ø0.8 to ø3.5 ø0.031 to ø0.138 approx.										

Notes: 1) Spot diameter, sensing range and distance to focal point are specified for FX-500 / FX-550 / FX-550L series.
 2) Note that the sensing range of the free-cut type fiber may be reduced by 20 % max. depending upon how the fiber is cut.
 3) The allowable cutting range is 700 mm 27.559 in from the end that the amplifier inserted.

Tough : Refer to a fiber which possesses both unbreakable (bending radius: R10 mm [R0.394 in](#), reciprocating bending: 180°) and more flexible (bending radius: R4 mm [R0.157 in](#) or less) features.
Bending durability : Refer to a fiber which possesses unbreakable bending-resistant feature (bending radius: R10 mm [R0.394 in](#), reciprocating bending: 180°).

LIST OF FIBERS

Small spot

Reflective type fiber & spot lens

Designation	Shape of head (mm)	Spot diameter (mm in) (Note 1)	Sensing range (mm in) (Note 1)	Lens		Applicable fibers						
				Model No.	Ambient temp.	Model No.	Fiber cable length : Free-cut (Note 2)	Bending radius (mm)	Protection	Ambient temp.		
Parallel light lens		ø4 ø0.157 approx.	0 to 30 0 to 1.181	FX-MR9	-55 to +70 °C	FD-R33EG	500 mm	R4	IP40		-20 to +60 °C	
						FD-EG31						
						FD-R34EG						
						FD-R32EG						
						FD-EG30	: 2 m	R2				-40 to +70 °C
						Tough FD-R31G						
						Tough FD-42G						
						FD-42GW						
						Tough FD-32G						
						FD-32GX						
Pinpoint spot lens		ø0.5 ø0.020	Distance to focal point 6 ±1 0.236 ±0.039	FX-MR1	-40 to +70 °C	Tough FD-42G		R2		-55 to +80 °C		
						FD-42GW					R1	-40 to +60 °C
Zoom lens		ø0.7 to ø2.0 ø0.028 to ø0.079 approx.	Distance to focal point 18.5 to 43 0.728 to 1.693 approx.	FX-MR2	-40 to +70 °C	Tough FD-42G	: 2 m	R2		-55 to +80 °C		
						FD-42GW					R1	-40 to +60 °C
Zoom lens (Side-view type)		ø0.5 to ø3.0 ø0.020 to ø0.118 approx.	Distance to focal point 13 to 30 0.512 to 1.181 approx.	FX-MR5	-40 to +60 °C	Tough FD-42G		R2		-55 to +80 °C		
						FD-42GW		R1		-40 to +60 °C		

Notes: 1) Spot diameter, sensing range and distance to focal point are specified for **FX-500 / FX-550 / FX-550L** series.
 2) Note that the sensing range of the free-cut type fiber may be reduced by 20 % max. depending upon how the fiber is cut.
 3) The allowable cutting range is 700 mm [27.559 in](#) from the end that the amplifier inserted.

Tough : Refer to a fiber which possesses both unbreakable (bending radius: R10 mm **R0.394 in**, reciprocating bending: 180°) and more flexible (bending radius: R4 mm **R0.157 in** or less) features.
Bending durability : Refer to a fiber which possesses unbreakable bending-resistant feature (bending radius: R10 mm **R0.394 in**, reciprocating bending: 180°).

LIST OF FIBERS

Narrow beam

*Thru-beam type sensors are available as two pieces per set.

Type	Shape of fiber head (mm)	Model No.	Bending radius (mm)	Fiber cable length Free-cut	Sensing range (mm in) (Note 1, 3, 4, 5)				Beam axis dia. (mm)	Inclination of beam axis	Protection	Ambient temp.
					FX-500 series		FX-550 / FX-550L series					
Thru-beam Narrow beam Side-view	Aperture angle 2° 	Tough (Bending durability) FT-KS40	R2	2 m	STD (Note 2) 3,600 141.732	3,600 141.732 (Note 2)	STD 3,600 141.732 (Note 2)	3,600 141.732 (Note 2)	ø2.2	—	IP40	-40 to +80 °C
		Tough (Bending durability) FT-KV40			HYPR (Note 2) 3,600 141.732	1,200 47.244	HYPR 3,600 141.732 (Note 2)	3,600 141.732 (Note 2)				
	Aperture angle 2° ø4 	Tough (Bending durability) FT-KV40W			STD (Note 2) 3,600 141.732	3,600 141.732 (Note 2)	STD 3,600 141.732 (Note 2)	3,600 141.732 (Note 2)				
	Aperture angle 2° ø4 	Tough (Bending durability) FT-KV26			HYPR (Note 2) 3,600 141.732	3,600 141.732 (Note 2)	HYPR 3,600 141.732 (Note 2)	3,600 141.732 (Note 2)				
	Aperture angle 3° 1.5 x 2 	Tough (Bending durability) FT-KV26H1			STD (Note 2) 3,600 141.732	3,600 141.732 (Note 2)	STD 3,600 141.732 (Note 2)	3,600 141.732 (Note 2)				
Aperture angle 3° 1.5 x 2 	Tough (Bending durability) FT-KV26H1	HYPR (Note 2) 3,600 141.732	3,600 141.732 (Note 2)	HYPR 3,600 141.732 (Note 2)	3,600 141.732 (Note 2)							
Retroreflective Ultra-narrow beam	With polarizing filter 	FR-Z50HW	R1	2 m	STD 100 to 990 3.937 to 38.976	100 to 1,400 3.937 to 55.118	STD 100 to 1,150 3.937 to 45.278	100 to 1,800 3.937 to 70.866	—	—	IP40	-25 to +55 °C
	Ultra-narrow beam 	Tough (Bending durability) FR-KZ22E	HYPR 100 to 1,900 3.937 to 74.803		100 to 1,200 3.937 to 47.244	HYPR 100 to 1,150 3.937 to 45.278	100 to 1,400 3.937 to 55.118					
	Aperture angle 3° (emitter) 	Tough (Bending durability) FR-KZ22E	STD 15 to 310 0.591 to 12.205		15 to 460 0.591 to 18.110	STD 15 to 540 0.591 to 21.260	15 to 700 0.591 to 27.559					
	W4 x H2 x D21.5 	Tough (Bending durability) FR-KZ22E	HYPR 15 to 570 0.591 to 22.441		15 to 220 0.591 to 8.661	HYPR 15 to 800 0.591 to 31.496	15 to 800 0.591 to 23.622					
	W4 x H2 x D21.5 	Tough (Bending durability) FR-KZ22E	STD 20 to 300 0.787 to 11.811		20 to 400 0.787 to 15.748	STD 20 to 400 0.787 to 15.748	20 to 1,300 0.787 to 51.181					
Retroreflective Narrow beam Top sensing	W5.2 x H9.5 x D21 	Tough (Bending durability) FR-KZ50H	R2	2 m	HYPR 20 to 1,000 0.787 to 39.370	20 to 200 0.787 to 7.874	HYPR 20 to 1,600 0.787 to 62.992	20 to 500 0.787 to 19.685	—	—	IP30	-40 to +60 °C
	Side sensing 	Tough (Bending durability) FR-KZ50E			STD 20 to 300 0.787 to 11.811	20 to 400 0.787 to 15.748	STD 20 to 400 0.787 to 15.748	20 to 1,300 0.787 to 51.181				
Retroreflective Narrow beam Side sensing	W9.5 x H25 x D5.2 	Tough (Bending durability) FR-KZ50E	R2	2 m	HYPR 20 to 1,000 0.787 to 39.370	20 to 200 0.787 to 7.874	HYPR 20 to 1,600 0.787 to 62.992	20 to 500 0.787 to 19.685	—	—	IP30	-40 to +60 °C
	W28 x H10.6 x D10.1 	Tough (Bending durability) FR-KZ50E			STD 20 to 300 0.787 to 11.811	20 to 400 0.787 to 15.748	STD 20 to 400 0.787 to 15.748	20 to 1,300 0.787 to 51.181				
Reflective Long range	W5.2 x H9.5 x D16 	FD-Z50HW	R1	2 m	STD 10 to 650 0.394 to 25.591	10 to 1,100 0.394 to 43.307	STD 10 to 950 0.394 to 37.402	10 to 2,100 0.394 to 82.677	—	—	IP40	-40 to +60 °C
		FD-Z50HW	HYPR 10 to 2,500 0.394 to 98.425		10 to 1,000 0.394 to 39.370	HYPR 10 to 3,700 0.394 to 154.669	10 to 590 0.394 to 23.228					

- Notes: 1) Note that the sensing range of the free-cut type fiber may be reduced by 20 % max. depending upon how the fiber is cut.
 2) The fiber cable length practically limits the sensing range.
 3) The **FX-550L** series does not have FAST mode.
 4) The sensing range of retroreflective type is the possible setting range for the attached reflector. The fiber can detect an object less than setting range for the reflector. Refer to the next page for the sensing range when **FR-Z50HW** is used in combination with a reflector (optional).
 5) The sensing range of reflective type is specified for white non-glossy paper.

Tough : Refer to a fiber which possesses both unbreakable (bending radius: R10 mm [R0.394 in](#), reciprocating bending: 180°) and more flexible (bending radius: R4 mm [R0.157 in](#) or less) features.
Bending durability : Refer to a fiber which possesses unbreakable bending-resistant feature (bending radius: R10 mm [R0.394 in](#), reciprocating bending: 180°).

LIST OF FIBERS

Wide beam

*Thru-beam type sensors are available as two pieces per set.

Type	Shape of fiber head (mm)	Model No.	Bending radius (mm)	Fiber cable length Free-cut	Sensing range (mm in) (Note 1, 4, 5)				Beam axis dia. (mm)	Protection	Ambient temp.	
					FX-500 series	Other modes	U-LG LONG FAST H-SP	FX-550 / FX-550L series				Other modes
Thru-beam	Wide beam	Tough (Bending durability) FT-A32 (Note 2) Sensing width 32mm W5 × H69 × D20	R2	2 m	STD (Note 3) 3,600 141.732 HYPR (Note 3) 3,600 141.732	3,600 141.732 (Note 3) 3,600 141.732 (Note 3) 2,100 82.677	U-LG LONG FAST H-SP	STD (Note 3) 3,600 141.732 HYPR (Note 3) 3,600 141.732	3,600 141.732 (Note 3) 3,600 141.732 (Note 3)	3.2 × 32	IP40	-40 to +60 °C
		Allows flexible wiring FT-A32W (Note 2) Sensing width 32mm W5 × H69 × D20	R1		STD (Note 3) 3,600 141.732 HYPR (Note 3) 3,600 141.732	3,600 141.732 (Note 3) 3,600 141.732 (Note 3) 3,000 118.110	U-LG LONG FAST H-SP	STD (Note 3) 3,600 141.732 HYPR (Note 3) 3,600 141.732	3,600 141.732 (Note 3) 3,600 141.732 (Note 3)			
	Array	Tough (Bending durability) FT-A11 (Note 2) Sensing width 11mm W4.2 × H31 × D13.5	R2		STD (Note 3) 3,600 141.732 HYPR (Note 3) 3,600 141.732	3,600 141.732 (Note 3) 3,600 141.732 (Note 3) 1,100 43.307	U-LG LONG FAST H-SP	STD (Note 3) 3,600 141.732 HYPR (Note 3) 3,600 141.732	3,600 141.732 (Note 3) 3,600 141.732 (Note 3)	2.2 × 11	IP40	-40 to +70 °C
		Allows flexible wiring FT-A11W (Note 2) Sensing width 11mm W4.2 × H31 × D13.5	R1		STD (Note 3) 3,600 141.732 HYPR (Note 3) 3,600 141.732	3,600 141.732 (Note 3) 3,600 141.732 (Note 3) 1,300 51.181	U-LG LONG FAST H-SP	STD (Note 3) 3,600 141.732 HYPR (Note 3) 3,600 141.732	3,600 141.732 (Note 3) 3,600 141.732 (Note 3)			
Reflective	Wide beam	Tough (Bending durability) FT-AL05 (Note 2) Sensing width 5.5mm W5 × H15 × D15	R2	2 m	STD 860 33.858 HYPR 2,300 90.551	1,550 61.024 1,500 59.055 500 19.685 170 6.693	U-LG LONG FAST H-SP	STD 1,150 45.276 HYPR 3,600 141.732 (Note 3)	2,350 92.520 1,600 62.992 660 25.984	0.25 × 5.5	IP40	-55 to +80 °C
		Tough (Bending durability) FD-A16 (Note 2) Sensing width 32mm W7 × H15 × D30	R4		STD 200 7.874 HYPR 140 5.512 Cannot use	200 7.874 200 7.874 140 5.512 75 2.953	U-LG LONG FAST H-SP	STD 350 13.780 HYPR —	350 13.780 250 9.843			
	Array	Tough (Bending durability) FD-AL11 (Note 2) Sensing width 5.5mm W5 × H20 × D20	R2		STD 320 12.598 HYPR 670 26.378	530 20.866 510 20.079 180 7.087 50 1.969	U-LG LONG FAST H-SP	STD 450 17.717 HYPR 1,300 51.181	1,000 39.370 700 27.559 320 12.598	IP40	-55 to +80 °C	
		Tough (Bending durability) FD-AL11 (Note 2) Sensing width 5.5mm W5 × H20 × D20	R2		STD 320 12.598 HYPR 670 26.378	530 20.866 510 20.079 180 7.087 50 1.969	U-LG LONG FAST H-SP	STD 450 17.717 HYPR 1,300 51.181	1,000 39.370 700 27.559 320 12.598			

- Notes: 1) Note that the sensing range of the free-cut type fiber may be reduced by 20 % max. depending upon how the fiber is cut.
 2) The slit mask (accessory) is sold separately. Refer to the last page for more details.
 3) The fiber cable length practically limits the sensing range.
 4) The **FX-550L** series does not have FAST mode.
 5) The sensing range of reflective type is specified for white non-glossy paper.

Tough : Refer to a fiber which possesses both unbreakable (bending radius: R10 mm **R0.394 in**, reciprocating bending: 180°) and more flexible (bending radius: R4 mm **R0.157 in** or less) features.
Bending durability : Refer to a fiber which possesses unbreakable bending-resistant feature (bending radius: R10 mm **R0.394 in**, reciprocating bending: 180°).

LIST OF FIBERS

Retroreflective type

Type	Shape of fiber head (mm)	Model No.	Bending radius (mm)	Fiber cable length ✂️: Free-cut	Sensing range (mm in) (Note 1, 2, 3)				Protection	Ambient temp.	
					FX-500 series		FX-550 / FX-550L series				
Retroreflective	With polarizing filters 	FR-Z50HW	R1	2 m	STD		STD		IP40	-25 to +55 °C	
					HYPR		HYPR				
	Ultra-narrow beam 	FR-KZ22E	STD		STD		STD				
			HYPR		HYPR		HYPR				
			STD		STD		STD				
			HYPR		HYPR		HYPR				
Narrow beam Top sensing 	FR-KZ50H	STD		STD		STD					
		HYPR		HYPR		HYPR					
		STD		STD		STD					
		HYPR		HYPR		HYPR					
Side sensing 	FR-KZ50E	STD		STD		STD					
		HYPR		HYPR		HYPR					

Notes: 1) Note that the sensing range of the free-cut type fiber may be reduced by 20 % max. depending upon how the fiber is cut.
 2) The sensing range is the possible setting range for the attached reflector. The fiber can detect an object less than setting range for the reflector.
 3) The **FX-550L** series does not have FAST mode.

<Sensing range when FR-Z50HW is used in combination with a reflector (optional)>

Reflector model No.	Sensing range (mm in)										
	FX-500 series					FX-550 / FX-550L series					
	HYPR	U-LG	LONG	STD	FAST	H-SP	HYPR	U-LG	LONG	STD	FAST
RF-230	100 to 19,000 3.937 to 748.030	100 to 8,000 3.937 to 314.960	100 to 5,000 3.937 to 196.850	100 to 3,600 3.937 to 141.732	100 to 2,900 3.937 to 114.173	100 to 1,400 3.937 to 55.118	100 to 20,000 3.937 to 78.402	100 to 11,000 3.937 to 433.071	100 to 7,000 3.937 to 275.591	100 to 5,000 3.937 to 196.850	100 to 3,500 3.937 to 137.795
RF-220	100 to 8,000 3.937 to 314.960	100 to 4,700 3.937 to 185.039	100 to 3,500 3.937 to 137.795	100 to 3,000 3.937 to 118.110	100 to 1,800 3.937 to 70.866	100 to 830 3.937 to 32.677	100 to 10,000 3.937 to 393.701	100 to 6,500 3.937 to 255.906	100 to 4,500 3.937 to 177.165	100 to 3,500 3.937 to 137.795	100 to 2,500 3.937 to 98.425
RF-210	100 to 5,500 3.937 to 216.535	100 to 2,700 3.937 to 106.299	100 to 2,400 3.937 to 94.488	100 to 1,500 3.937 to 59.055	100 to 1,200 3.937 to 47.244	100 to 530 3.937 to 20.866	100 to 7,000 3.937 to 275.591	100 to 4,000 3.937 to 157.480	100 to 3,600 3.937 to 141.732	100 to 2,800 3.937 to 110.236	100 to 2,100 3.937 to 82.677

Note: 1) The sensing range is the possible setting range for the reflector. The fiber can detect an object less than 100 mm **3.937 in**. However, note that if there are any white or highly-reflective surfaces near the fiber head, reflected incident light may affect the fiber head. If this occurs, adjust the threshold value of the amplifier unit before use.
 2) The **FX-550L** series does not have FAST mode.

Tough : Refer to a fiber which possesses both unbreakable (bending radius: R10 mm **R0.394 in**, reciprocating bending: 180°) and more flexible (bending radius: R4 mm **R0.157 in** or less) features.
Bending durability : Refer to a fiber which possesses unbreakable bending-resistant feature (bending radius: R10 mm **R0.394 in**, reciprocating bending: 180°).

LIST OF FIBERS

<Heat-resistant joint fiber set contents>

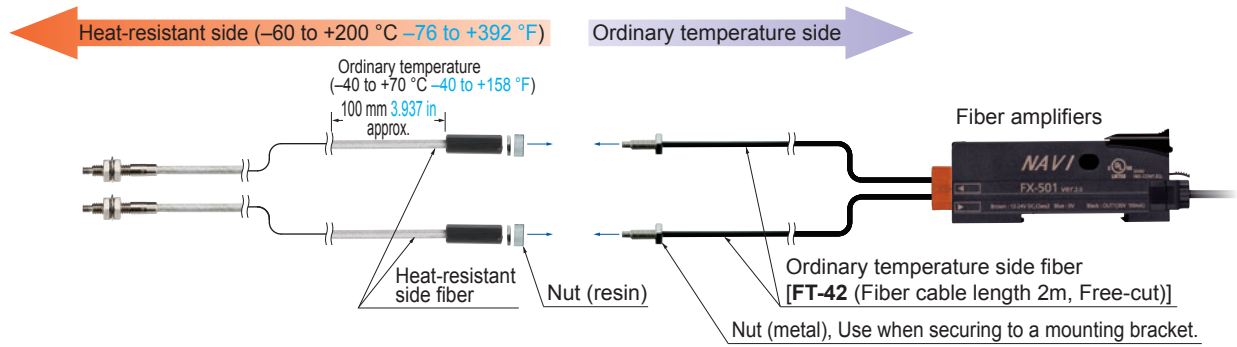

Heat-resistant

*Thru-beam type sensors are available as two pieces per set.

Type	Heat-resistant temp.	Shape of fiber head (mm)	Model No.	Bending radius (mm)	Fiber cable length Free-cut	Sensing range (mm in) (Note 1, 3)					Beam axis dia. (mm)	Ambient temp.
						FX-500 series		FX-550 / FX-550L series		Other modes		
Thru-beam	350 °C	Lens mountable (FX-LE1/LE2/SV1)	FT-H35-M2	R25	2 m	STD 880 34.646	1,050 41.339	2,300 90.551	Other modes	U-LG LONG FAST	ø1.2	-60 to +350 °C
		Sleeve 60 mm	FT-H35-M2S6	Fiber R25 Sleeve R10		HYPR 670 26.378						
	200 °C	Allows flexible wiring Lens mountable (FX-LE1/LE2/SV1)	FT-H20W-M1	R10	1 m	STD 1,000 39.370	730 28.740	1,600 62.992 (Note 2)	Other modes	U-LG LONG FAST	ø0.8	-60 to +200 °C
		Lens mountable (FX-LE1/LE2/SV1)	FT-H20-M1	R25		HYPR 840 33.071						
Heat-resistant (joint)	200 °C	Lens mountable (FX-LE2 only)	FT-H13-FM2	R25	2 m	STD 1,300 51.181	1,150 45.276	2,700 106.299	Other modes	U-LG LONG FAST	ø1.5	-60 to +130 °C
		Lens mountable (FX-LE1/LE2/SV1)	FT-H20-J20-S (Note 6)	Heat-resistant side R18 (Note 5)		HYPR 960 37.795						
Heat-resistant (joint)	200 °C	Lens mountable (FX-LE1/LE2/SV1)	FT-H20-J30-S (Note 6)	R18	Heat-resistant side R18 (Note 5)	STD 1,300 51.181	1,150 45.276	2,700 106.299	Other modes	U-LG LONG FAST	ø1.2	-60 to +200 °C
		Lens mountable (FX-LE1/LE2/SV1)	FT-H20-J50-S (Note 6)	HYPR 700 27.559		HYPR 3,300 129.921						
		Lens mountable (FX-LE1/LE2/SV1)	FT-H20-VJ50-S (Note 6)	HYPR 1,900 74.803		HYPR 1,400 55.118						
		Side-view	FT-H20-VJ80-S (Note 6)	HYPR 1,300 51.181		HYPR 3,600 141.732 (Note 2)						
Heat-resistant (joint)	200 °C	Lens mountable (FX-LE1/LE2/SV1)	FT-H20-VJ50-S (Note 6)	R18	Heat-resistant side R18 (Note 5)	STD 1,300 51.181	1,150 45.276	2,700 106.299	Other modes	U-LG LONG FAST	ø1.2	-60 to +200 °C
		Lens mountable (FX-LE1/LE2/SV1)	FT-H20-VJ80-S (Note 6)	HYPR 1,300 51.181		HYPR 3,600 141.732 (Note 2)						

- Notes: 1) Note that the sensing range of the free-cut type fiber may be reduced by 20 % max. depending upon how the fiber is cut.
 2) The fiber cable length practically limits the sensing range.
 3) The **FX-550L** series does not have FAST mode.
 4) Fiber length (fixed-length) for heat-resistant fiber side. Fiber length for ordinary temperature side is 2 m **6.562 ft** (free-cut).
 5) Bending-resistant fiber R4 mm **R0.157 in** or more for ordinary temperature side.
 6) Heat-resistant joint fibers and ordinary-temperature fibers (**FT-42**) are sold as a set.

Tough : Refer to a fiber which possesses both unbreakable (bending radius: R10 mm **R0.394 in**, reciprocating bending: 180°) and more flexible (bending radius: R4 mm **R0.157 in** or less) features.
Bending durability : Refer to a fiber which possesses unbreakable bending-resistant feature (bending radius: R10 mm **R0.394 in**, reciprocating bending: 180°).

LIST OF FIBERS

Heat-resistant

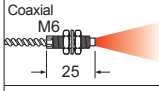
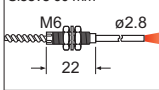
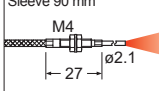
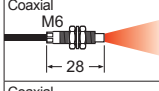
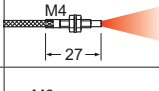
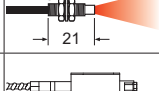
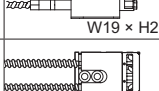
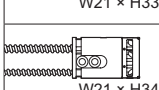
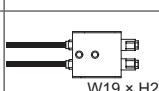
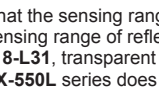
Type	Heat-resistant temp.	Shape of fiber head (mm)	Model No.	Bending radius (mm)	Fiber cable length ✂️: Free-cut	Sensing range (mm in) (Note 1, 2, 3)					Ambient temp.				
						FX-500 series	Other modes	U-LG LONG FAST H-SP	FX-550 / FX-550L series	Other modes		U-LG LONG FAST			
Reflective Heat-resistant	350 °C		FD-H35-M2	R25	2 m	STD 260 10.236		540 21.260 460 18.110 150 5.906 45 1.772	STD 400 15.748 HYPR 750 29.528		600 23.662 500 19.685 220 8.661	-60 to +350 °C			
			Sleeve 60 mm 	FD-H35-M2S6		Fiber R25 Sleeve R10		HYPR 720 28.346							
		Sleeve 90 mm 	FD-H35-20S			STD 260 10.236 HYPR 840 33.071		550 21.654 440 17.323 140 5.512 45 1.772	STD 410 16.142 HYPR 850 33.465		750 29.528 550 21.654 230 9.055				
			200 °C	Coaxial M6 		FD-H20-M1	R25	1 m	STD 330 12.992 HYPR 840 33.071		550 21.654 500 19.685 200 7.874 55 2.165		STD 450 17.717 HYPR 1,350 53.150		1,000 39.370 650 25.591 300 11.811
		Coaxial M4 		FD-H20-21		STD 230 9.055 HYPR 770 30.315				500 19.685 380 14.961 130 5.118 45 1.772	STD 450 17.717 HYPR 1,250 49.213			850 33.465 650 25.591 250 9.843	
		130 °C	M6 	FD-H13-FM2			✂️ 2 m	STD 350 13.780 HYPR 880 34.646		640 25.197 600 23.622 200 7.874 65 2.559	STD 670 26.378 HYPR 1,650 64.961			1,300 51.181 940 37.008 390 15.354	-60 to +130 °C
	Glass substrate detection convergent reflective	300 °C		FD-H30-L32	R25	2 m	STD 0 to 17 0 to 0.669 HYPR 0 to 40 0 to 1.575	0 to 30 0 to 1.181 0 to 25 0 to 0.984 0 to 12 0 to 0.472 1.5 to 6 0.059 to 0.236	STD 0 to 21 0 to 0.827 HYPR 0 to 60 0 to 2.362		0 to 42 0 to 1.654 0 to 25 0 to 0.984 0 to 16 0 to 0.630	-60 to +300 °C			
		250 °C		FD-H25-L43	R25		3 m	STD 1.5 to 26 0.059 to 1.024 HYPR 1 to 31 0.039 to 1.220	1 to 30 0.039 to 1.181 1 to 28 0.039 to 1.102 1.5 to 24 0.059 to 0.945 2 to 18 0.079 to 0.709	STD 1 to 28 0.039 to 1.102 HYPR 1 to 31 0.039 to 1.220		1 to 30 0.039 to 1.181 1 to 29 0.039 to 1.142 1 to 26 0.039 to 1.024	-20 to +250 °C (Ordinary temp. side:)		
				FD-H25-L45				STD 5 to 42 0.197 to 1.654 HYPR 4 to 43.5 0.157 to 1.713	4 to 43 0.157 to 1.693 4.5 to 43 0.177 to 1.693 5 to 40 0.197 to 1.575 6.5 to 34 0.256 to 1.339	STD 4 to 48 0.157 to 1.890 HYPR 4 to 51 0.157 to 2.008		4 to 50 0.157 to 1.969 4 to 49 0.157 to 1.929 4 to 44 0.157 to 1.732			
		180 °C		FD-H18-L31			✂️ 2 m	STD 0 to 16 0 to 0.630 HYPR 0 to 60 0 to 2.362	0 to 32 0 to 1.260 0 to 24 0 to 0.945 0 to 13 0 to 0.512 2 to 6.5 0.079 to 0.256	STD 0 to 45 0 to 1.772 HYPR 0 to 130 0 to 5.118		0 to 85 0 to 3.346 0 to 60 0 to 2.362 0 to 30 0 to 1.181	-60 to +180 °C		

- Notes: 1) Note that the sensing range of the free-cut type fiber may be reduced by 20 % max. depending upon how the fiber is cut.
 2) The sensing range of reflective type is the value for white non-glossy paper (50 × 50 mm **1.969 × 1.969 in** glass substrate for **FD-H30-L32** and **FD-H18-L31**, transparent glass 100 × 100 × 10.7 mm **3.937 × 3.937 × 10.028 in** for **FD-H25-L43** and **FD-H25-L45**).
 3) The **FX-550L** series does not have FAST mode.

Tough : Refer to a fiber which possesses both unbreakable (bending radius: R10 mm **R0.394 in**, reciprocating bending: 180°) and more flexible (bending radius: R4 mm **R0.157 in** or less) features.
Bending durability : Refer to a fiber which possesses unbreakable bending-resistant feature (bending radius: R10 mm **R0.394 in**, reciprocating bending: 180°).

LIST OF FIBERS

Oil-resistant

*Thru-beam type sensors are available as two pieces per set.

Type	Shape of fiber head (mm)	Model No.	Bending radius (mm)	Fiber cable length Free-cut	Sensing range (mm in) (Note 1, 2, 3)				Beam axis dia. (mm)	Protection	Ambient temp.	
					FX-500 series	Other modes	U-LG LONG FAST H-SP	FX-550 / FX-550L series				Other modes
Thru-beam Oil-resistant Square head type	Full-protection type W10 × H11 × D21.2	Tough (Bending durability) FT-R60Y	R4	2 m	STD 2,100 82.677	3,600 141.732 (Note 4)	3,600 141.732 (Note 4)	STD 3,600 141.732 (Note 4)	3,600 141.732 (Note 4)	ø3.5	IP68G	-55 to +80 °C
	Cable-protection type Lens mountable W7 × H9.5 × D15.5	Tough (Bending durability) FT-R44Y			HYPR (Note 4) 3,600 141.732	1,260 49.606 400 15.748	3,600 141.732 (Note 4)	HYPR 3,600 141.732 (Note 4)	1,900 74.803			
Reflective Oil-resistant Square head type	Cable-protection type W10 × H11 × D15.5	Tough (Bending durability) FD-R61Y	R4	2 m	STD 280 11.024	610 24.016 435 17.126 160 6.299	STD 450 17.717 HYPR 1,350 53.150	HYPR 3,600 141.732 (Note 4)	1,000 39.370 650 25.591 250 9.843	—	IP67 (Note 5)	-55 to +80 °C

- Notes: 1) Note that the sensing range of the free-cut type fiber may be reduced by 20 % max. depending upon how the fiber is cut.
 2) The **FX-550L** series does not have FAST mode.
 3) The sensing range of reflective type is specified for white non-glossy paper.
 4) The fiber cable length practically limits the sensing range.
 5) The fiber part is oil-resistant.

Chemical-resistant

*Thru-beam type sensors are available as two pieces per set.

Type	Shape of fiber head (mm)	Model No.	Bending radius (mm)	Fiber cable length Free-cut	Sensing range (mm in) (Note 1, 2, 3)				Beam axis dia. (mm)	Protection	Ambient temp.	
					FX-500 series	Other modes	U-LG LONG FAST H-SP	FX-550 / FX-550L series				Other modes
Thru-beam Chemical-resistant	Easy mounting • Rectangular head SEMI S2 compliant (Note 6) Metal-free W7 × H15 × D13	Tough (Bending durability) FT-Z802Y	R4	2 m	STD 3,100 122.047	3,600 141.732 (Note 4)	3,600 141.732 (Note 4)	STD 3,600 141.732 (Note 4)	3,600 141.732 (Note 4)	ø3.7	IP68G	0 to +60 °C
	Heat-resistant 115 °C Metal-free ø5.5	FT-HL80Y			HYPR (Note 4) 3,600 141.732	1,900 74.803 470 18.504	3,600 141.732 (Note 4)	HYPR 3,600 141.732 (Note 4)	3,600 141.732 (Note 4)			
	Metal-free ø5.5	FT-L80Y	STD (Note 4) 3,600 141.732	3,600 141.732 (Note 4)	3,600 141.732 (Note 4)	STD 3,600 141.732 (Note 4)	3,600 141.732 (Note 4)					
	Side-view Metal-free ø5.5	FT-V80Y	HYPR (Note 4) 3,600 141.732	2,800 110.236 920 36.220	3,600 141.732 (Note 4)	HYPR 3,600 141.732 (Note 4)	3,600 141.732 (Note 4)					
Reflective Chemical-resistant Cylindrical type	Metal-free ø5.5	Tough (Bending durability) FD-S60Y	R4	2 m (Note 5)	STD 320 12.598	590 23.228 420 16.535 200 7.874 75 2.953	STD 450 17.717 HYPR —	HYPR 3,600 141.732 (Note 4)	700 27.559 550 21.654 380 14.961	—	IP68G	-40 to +70 °C

- Notes: 1) Note that the sensing range of the free-cut type fiber may be reduced by 20 % max. depending upon how the fiber is cut.
 2) The **FX-550L** series does not have FAST mode.
 3) The sensing range of reflective type is specified for white non-glossy paper.
 4) The fiber cable length practically limits the sensing range.
 5) The allowable cutting range is 500 mm **19.685 in** from the end that the amplifier inserted.
 6) The design takes into account the environmental testing required by SEMI S2. To ensure that the final system complies with the standards, you must design and use it in accordance with relevant standards, regulations, and regulations.

Tough : Refer to a fiber which possesses both unbreakable (bending radius: R10 mm **R0.394 in**, reciprocating bending: 180°) and more flexible (bending radius: R4 mm **R0.157 in** or less) features.
Bending durability : Refer to a fiber which possesses unbreakable bending-resistant feature (bending radius: R10 mm **R0.394 in**, reciprocating bending: 180°).

LIST OF FIBERS

<One-touch connection system compatible with 4CH / 1CH flange Vacuum-resistant fiber set contents>

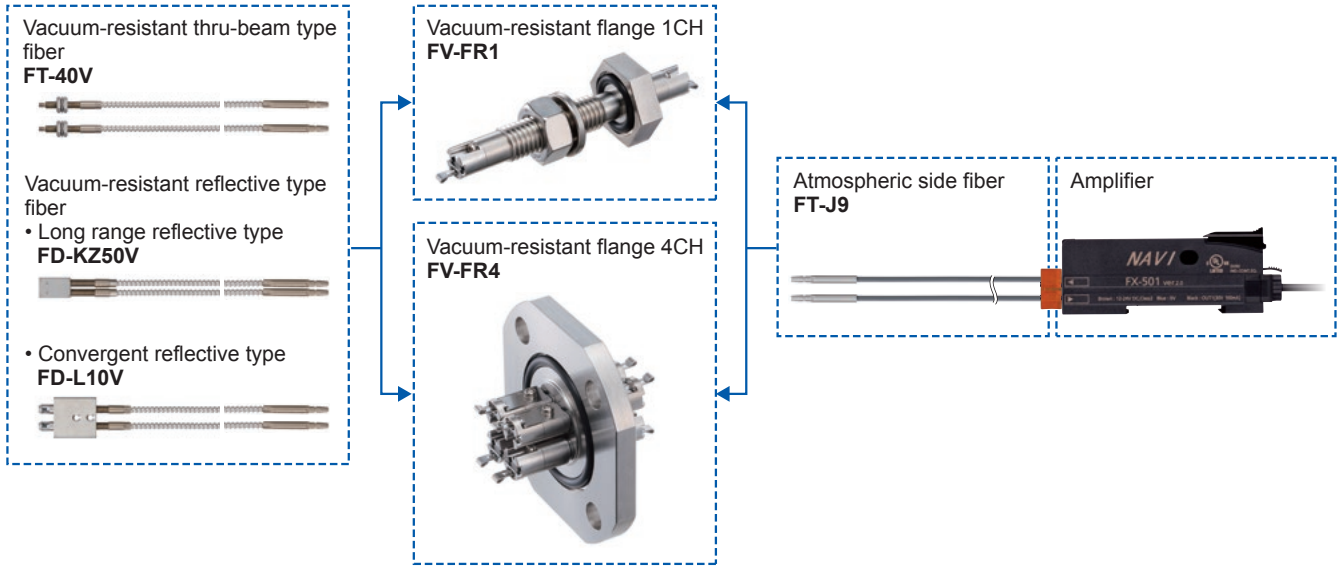

Vacuum-resistant (One-touch connection system compatible with 4CH / 1CH flange)

*Thru-beam type sensors are available as two pieces per set.

Type	Shape of fiber head (mm)	Model No.	Bending radius (mm)	Fiber cable length	Sensing range (mm in) (Note 3, 4)						Beam axis dia. (mm)	Ambient temp.		
					FX-500 series	Other modes	U-LG LONG FAST H-SP	FX-550 / FX-550L series	Other modes	U-LG LONG FAST				
Thru-beam	300 °C, Lens mountable (FV-LE1/SV1/SV2) 	FT-40V	R25	1 m (Note 2)	STD 270 10.630 HYPR 1,000 39.370	590 23.228 470 18.504 160 6.299 55 2.165		STD 400 15.748 HYPR 1,400 55.118	950 37.402 620 24.409 250 9.843	10 to 1,000 15 to 270 20 to 120 5 to 1,500 20 to 45 0.197 to 19.685	0.394 to 13.386 0.787 to 7.874 0.591 to 10.630 0.787 to 4.724 0.197 to 1.772	0.787 to 17.717 0.591 to 25.591 0.787 to 11.811	Ø1.3	-30 to +300 °C
Vacuum-resistant	300 °C, Rectangular head 	FD-KZ50V	R25	1 m (Note 2)	STD 20 to 200 0.787 to 7.874 HYPR 5 to 500 0.197 to 19.685	10 to 340 15 to 270 20 to 120 5 to 1,500 20 to 45 0.197 to 1.772		STD 20 to 450 HYPR 5 to 1,500 20 to 300	10 to 1,000 15 to 650 20 to 300	0.394 to 39.370 0.591 to 25.591 0.787 to 11.811				-30 to +300 °C
Convergent reflective	300 °C, Glass substrate detection 	FD-L10V		3 m (Note 2)	STD 0 to 8 0 to 0.315 HYPR 0 to 18 0 to 0.709	0 to 12 0 to 0.472 0 to 10 0 to 0.394 0 to 5.5 0 to 0.217 1.5 to 3 0.059 to 0.118		STD 0 to 11 0 to 0.433 HYPR 0 to 27 0 to 1.063	0 to 19 0 to 0.748 0 to 13 0 to 0.512 0 to 7.5 0 to 0.295					

- Notes: 1) Atmospheric side fiber is optional and sold separately.
- 2) This is not a "free-cut" type. We offer only semi-custom products in which the fiber length can be specified in 100 mm 3.937 in increments. For details, please contact our sales office.
- 3) The sensing range is the value for transparent glass 100 × 100 × t0.7 mm 3.937 × 3.937 × t0.028 in.
- 4) FX-550L series does not have FAST mode.

Atmospheric side (one pair set)



Type	Shape of fiber head (mm)	Model No.	Bending radius (mm)	Fiber cable length ✂: Free-cut	Ambient temp.
Atmospheric side		Tough Bending durability FT-J9	R4	✂ 2 m (Note 1, 2)	-30 to +80 °C

- Notes: 1) We offer only semi-custom products in which the fiber length can be specified in 1 m 3.280 ft increments. For details, please contact our sales office.
- 2) Note that the sensing range of the free-cut type fiber may be reduced by 20 % max. depending upon how the fiber is cut.

Tough : Refer to a fiber which possesses both unbreakable (bending radius: R10 mm **R0.394 in**, reciprocating bending: 180°) and more flexible (bending radius: R4 mm **R0.157 in** or less) features.
Bending durability : Refer to a fiber which possesses unbreakable bending-resistant feature (bending radius: R10 mm **R0.394 in**, reciprocating bending: 180°).

LIST OF FIBERS

Vacuum-resistant flange

Designation	Model No.	Description	
Vacuum-resistant flange 1CH	FV-FR1		Atmospheric side and vacuum side are isolated.
			Main specifications
Vacuum-resistant flange 4CH	FV-FR4		Model No.
			Applicable fibers
			Leakage
			Ambient temperature
			Ambient humidity
			Tightening torque
			Tensile strength
			O-ring size
			Weight
			Material

Recommended thickness of vacuum chamber wall
 • For **FV-FR1**: 3.0 to 40.0 mm **0.118 to 1.575 in** (Note 1)
 • For **FV-FR4**: 3.0 mm **0.118 in** or more (Note 2)

Notes: 1) Confirm the wall thickness in advance since the **FV-FR1** cannot be installed to a vacuum chamber with a wall thickness outside the recommended thickness range.
 2) If the vacuum chamber wall is too thick, the **FV-FR4** may not be able to connect to the vacuum side fiber. In that case, connect the **FV-FR4** to the vacuum side fiber before the installation.

<Vacuum-resistant fiber set contents>

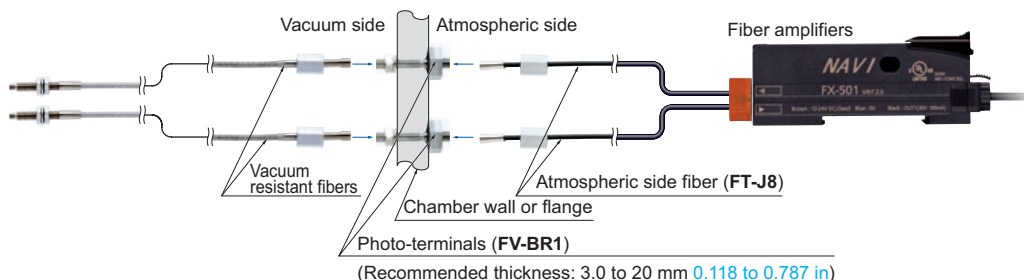

Vacuum-resistant

*Thru-beam type sensors are available as two pieces per set.

Type	Shape of fiber head (mm)	Model No.	Bending radius (mm)	Fiber cable length	Sensing range (mm in) (Note 3, 4)				Beam axis dia. (mm)	Ambient temp.
					FX-500 series		FX-550 / FX-550L series			
Thru-beam	300 °C Lens mountable (FV-LE1/SV2) M4 30	FT-H30-M1V-S (Note 1)	R18	1 m (Note 2)	STD	590 23.228	STD	950 37.402	ø1.2	-30 to +300 °C
					HYP	470 18.504 160 6.299 55 2.165	HYP	400 15.748 620 24.409 250 9.843		
Reflective	300 °C, Rectangular head W9.5 × H5.2 × D15	FD-H30-KZ1V-S (Note 1)	R18	1 m (Note 2)	STD	10 to 340 0.394 to 13.386	STD	10 to 1,000 0.394 to 39.370	-	-30 to +300 °C
					HYP	15 to 270 0.591 to 10.630 20 to 120 0.787 to 4.724 20 to 45 0.787 to 1.772	HYP	20 to 450 0.787 to 17.717 15 to 650 0.591 to 25.591 20 to 300 0.787 to 11.811		
Convergent reflective	300 °C, Glass substrate detection W19 × H5 × D27	FD-H30-L32V-S (Note 1)	R18	3 m (Note 2)	STD	0 to 12 0 to 0.472 0 to 10 0 to 0.394 0 to 5.5 0 to 0.217 1.5 to 3 0.059 to 0.118	STD	0 to 19 0 to 0.748 0 to 13 0 to 0.512 0 to 7.5 0 to 0.295		

Notes: 1) Sold as a set comprising vacuum type fiber + photo-terminal (**FV-BR1**) + fiber at atmospheric side (**FT-J8**).
 2) This is not a "free-cut" type.
 3) **FX-550L** series does not have FAST mode.
 4) The sensing range is the value for transparent glass 100 × 100 × 0.7 mm **3.937 × 3.937 × 0.028 in**.

Tough : Refer to a fiber which possesses both unbreakable (bending radius: R10 mm **R0.394 in**, reciprocating bending: 180°) and more flexible (bending radius: R4 mm **R0.157 in** or less) features.
Bending durability : Refer to a fiber which possesses unbreakable bending-resistant feature (bending radius: R10 mm **R0.394 in**, reciprocating bending: 180°).

LIST OF FIBERS

Liquid leak / Liquid detection

Type	Shape of fiber head (mm)	Model No.	Bending radius (mm)	Fiber cable length : Free-cut	Description		Protection	Ambient temp.
					FX-500 series (STD mode)	FX-550 / FX-550L series (STD mode)		
Reflective type	Contact type	Liquid level sensing	Heat resistant 125 °C Fluorine resin coating ø6 	FD-F8Y	Protective tube R40 Fiber R15 2 m (Note 1)	ø6 mm ø0.236 in Protective tube: Fluorine resin, length 1,000 mm 39.370 in (not cuttable) Liquid surface not contacted: Beam received, Liquid surface contacted: Beam not received	IP68	-40 to +125 °C
			Heat resistant 105 °C Fluorine resin coating Metal-free ø4 	FD-HF40Y (Note 2)	Protective tube R20 Fiber R10 2 m	ø4 mm ø0.157 in Protective tube: Fluorine resin, length 500 mm 19.685 in (cuttable) Liquid surface not contacted: Beam received, Liquid surface contacted: Beam not received	IP68G	-40 to +105 °C
			Heat resistant 70 °C Fluorine resin coating throughout the fiber Metal-free ø4 	FD-F41Y (Note 2)		ø4 mm ø0.157 in Protective tube: Fluorine resin, length 500 mm 19.685 in (cuttable) Liquid surface not contacted: Beam received, Liquid surface contacted: Beam not received		-40 to +70 °C
	Liquid leak detection	SEMI S2 compliant (Note 3) W20 × H30 × D10 	Tough <small>Bending durability</small> FD-F71	R4 5 m	Liquid leak detection Leak absent: Beam received, Leak present: Beam not received Compatible amplifier: FX-500 / FX-550 / FX-550L series only	IP67	-20 to +60 °C	
Reflective type	Pipe-mountable type	Liquid level sensing	Standard W25 × H13 × D20 	FD-F41	R10 	Applicable pipe diameter: Outer dia. ø6 to ø26 mm ø0.236 to ø1.024 in transparent pipe [PVC (vinyl chloride), fluorine resin, polycarbonate, acrylic, glass, wall thickness 1 to 3 mm 0.039 to 0.118 in] Liquid absent: Beam received, Liquid present: Beam not received	—	-40 to +100 °C
			For 1 mm thick PFA pipe W25 × H13 × D20 			FD-F4		
		Liquid sensing	Array fiber W6.5 × H28.3 × D17 	Tough <small>Bending durability</small> FD-FA93	R4 2 m	Applicable pipe diameter: Outer dia. ø8 mm ø0.315 in or more transparent pipe (When used with the tying bands: ø8 to ø80 mm ø0.315 to ø3.150 in) [PFA (fluorine resin), including translucent] Liquid absent: Beam received, Liquid present: Beam not received	IP40	-40 to +70 °C
	Liquid sensing	SEMI S2 compliant (Note 3) W23 × H20 × D17 	Tough <small>Bending durability</small> FT-F93	Protective tube R20 Fiber R2 	Applicable pipe diameter: Outer dia. ø3 to ø10 mm ø0.118 to ø0.394 in transparent pipe [PFA (fluorine resin) or equivalently transparent pipe, wall thickness 0.3 to 1 mm 0.012 to 0.039 in] Liquid absent: Beam not received, Liquid present: Beam received Compatible amplifier: FX-500 / FX-550 / FX-550L series only	-40 to +60 °C		

- Notes: 1) The allowable cutting range is 1,000 mm **39.370 in** from the end that the amplifier inserted.
 2) Liquid inflow prevention joint, protective tube extension joint, fiber mounting joint is available.
 3) The design takes into account the environmental testing required by SEMI S2. To ensure that the final system complies with the standards, you must design and use it in accordance with relevant standards, regulations, and regulations.

FIBER OPTIONS

Lens (For thru-beam type fiber)

Designation	Model No.	Description																																																																																																																																																																																																																					
Expansion lens (Note 1)	FX-LE1	<p>Increases the sensing range by 5 times or more.</p> <p>• Ambient temperature: -60 to +350 °C -76 to +662 °F (Note 4) • Beam dia: ø3.6 mm ø0.142 in</p> <p>Sensing range (mm in) [Lens on both sides] (Note 3)</p> <table border="1"> <thead> <tr> <th colspan="2">Amplifier</th> <th colspan="5">FX-500 series (Upper value) FX-550 / FX-550L series (Lower value)</th> </tr> <tr> <th>Fiber</th> <th>Mode</th> <th>HYPR</th> <th>U-LG</th> <th>LONG</th> <th>STD</th> <th>FAST</th> <th>H-SP</th> </tr> </thead> <tbody> <tr> <td rowspan="3">FT-43</td> <td></td> <td>3,600</td> <td>3,600</td> <td>3,600</td> <td>3,600</td> <td>3,600</td> <td>1,600</td> </tr> <tr> <td></td> <td>141.732 (Note 2)</td> <td>141.732 (Note 2)</td> <td>141.732 (Note 2)</td> <td>141.732 (Note 2)</td> <td>141.732 (Note 2)</td> <td>62.992</td> </tr> <tr> <td></td> <td>3,600</td> <td>3,600</td> <td>3,600</td> <td>3,600</td> <td>3,600</td> <td>—</td> </tr> <tr> <td rowspan="3">FT-42 FT-42W</td> <td></td> <td>3,600</td> <td>3,600</td> <td>3,600</td> <td>3,600</td> <td>3,600</td> <td>2,200</td> </tr> <tr> <td></td> <td>141.732 (Note 2)</td> <td>141.732 (Note 2)</td> <td>141.732 (Note 2)</td> <td>141.732 (Note 2)</td> <td>141.732 (Note 2)</td> <td>86.614</td> </tr> <tr> <td></td> <td>3,600</td> <td>3,600</td> <td>3,600</td> <td>3,600</td> <td>3,600</td> <td>—</td> </tr> <tr> <td rowspan="3">FT-45X</td> <td></td> <td>1,600</td> <td>1,600</td> <td>1,600</td> <td>1,600</td> <td>1,600</td> <td>1,500</td> </tr> <tr> <td></td> <td>62.992 (Note 2)</td> <td>62.992 (Note 2)</td> <td>62.992 (Note 2)</td> <td>62.992 (Note 2)</td> <td>62.992 (Note 2)</td> <td>59.055</td> </tr> <tr> <td></td> <td>1,600</td> <td>1,600</td> <td>1,600</td> <td>1,600</td> <td>1,600</td> <td>—</td> </tr> <tr> <td rowspan="3">FT-R40</td> <td></td> <td>3,600</td> <td>3,600</td> <td>3,600</td> <td>3,600</td> <td>3,600</td> <td>1,900</td> </tr> <tr> <td></td> <td>141.732 (Note 2)</td> <td>141.732 (Note 2)</td> <td>141.732 (Note 2)</td> <td>141.732 (Note 2)</td> <td>141.732 (Note 2)</td> <td>74.803</td> </tr> <tr> <td></td> <td>3,600</td> <td>3,600</td> <td>3,600</td> <td>3,600</td> <td>3,600</td> <td>—</td> </tr> <tr> <td rowspan="3">FT-R43 FT-R44Y</td> <td></td> <td>3,600</td> <td>3,600</td> <td>3,600</td> <td>3,600</td> <td>1,900</td> <td>670</td> </tr> <tr> <td></td> <td>141.732 (Note 2)</td> <td>141.732 (Note 2)</td> <td>141.732 (Note 2)</td> <td>141.732 (Note 2)</td> <td>74.803</td> <td>26.378</td> </tr> <tr> <td></td> <td>3,600</td> <td>3,600</td> <td>3,600</td> <td>3,600</td> <td>3,600</td> <td>—</td> </tr> <tr> <td rowspan="3">FT-H35-M2</td> <td></td> <td>3,600</td> <td>3,600</td> <td>3,600</td> <td>3,600</td> <td>3,300</td> <td>1,400</td> </tr> <tr> <td></td> <td>141.732 (Note 2)</td> <td>141.732 (Note 2)</td> <td>141.732 (Note 2)</td> <td>141.732 (Note 2)</td> <td>129.921</td> <td>55.118</td> </tr> <tr> <td></td> <td>3,600</td> <td>3,600</td> <td>3,600</td> <td>3,600</td> <td>3,600</td> <td>—</td> </tr> <tr> <td rowspan="3">FT-H20W-M1</td> <td></td> <td>1,600</td> <td>1,600</td> <td>1,600</td> <td>1,600</td> <td>1,600</td> <td>850</td> </tr> <tr> <td></td> <td>62.992 (Note 2)</td> <td>62.992 (Note 2)</td> <td>62.992 (Note 2)</td> <td>62.992 (Note 2)</td> <td>62.992 (Note 2)</td> <td>33.465</td> </tr> <tr> <td></td> <td>1,600</td> <td>1,600</td> <td>1,600</td> <td>1,600</td> <td>1,600</td> <td>—</td> </tr> <tr> <td rowspan="3">FT-H20-M1</td> <td></td> <td>1,600</td> <td>1,600</td> <td>1,600</td> <td>1,600</td> <td>1,600</td> <td>1,200</td> </tr> <tr> <td></td> <td>62.992 (Note 2)</td> <td>62.992 (Note 2)</td> <td>62.992 (Note 2)</td> <td>62.992 (Note 2)</td> <td>62.992 (Note 2)</td> <td>47.244</td> </tr> <tr> <td></td> <td>1,600</td> <td>1,600</td> <td>1,600</td> <td>1,600</td> <td>1,600</td> <td>—</td> </tr> <tr> <td rowspan="3">FT-H20-J50-S FT-H20-J30-S FT-H20-J20-S</td> <td></td> <td>3,600</td> <td>3,600</td> <td>3,500</td> <td>2,000</td> <td>1,600</td> <td>500</td> </tr> <tr> <td></td> <td>141.732 (Note 2)</td> <td>141.732 (Note 2)</td> <td>137.795</td> <td>78.740</td> <td>62.992</td> <td>19.685</td> </tr> <tr> <td></td> <td>3,600</td> <td>3,600</td> <td>3,600</td> <td>3,600</td> <td>3,600</td> <td>—</td> </tr> </tbody> </table>	Amplifier		FX-500 series (Upper value) FX-550 / FX-550L series (Lower value)					Fiber	Mode	HYPR	U-LG	LONG	STD	FAST	H-SP	FT-43		3,600	3,600	3,600	3,600	3,600	1,600		141.732 (Note 2)	141.732 (Note 2)	141.732 (Note 2)	141.732 (Note 2)	141.732 (Note 2)	62.992		3,600	3,600	3,600	3,600	3,600	—	FT-42 FT-42W		3,600	3,600	3,600	3,600	3,600	2,200		141.732 (Note 2)	141.732 (Note 2)	141.732 (Note 2)	141.732 (Note 2)	141.732 (Note 2)	86.614		3,600	3,600	3,600	3,600	3,600	—	FT-45X		1,600	1,600	1,600	1,600	1,600	1,500		62.992 (Note 2)	62.992 (Note 2)	62.992 (Note 2)	62.992 (Note 2)	62.992 (Note 2)	59.055		1,600	1,600	1,600	1,600	1,600	—	FT-R40		3,600	3,600	3,600	3,600	3,600	1,900		141.732 (Note 2)	141.732 (Note 2)	141.732 (Note 2)	141.732 (Note 2)	141.732 (Note 2)	74.803		3,600	3,600	3,600	3,600	3,600	—	FT-R43 FT-R44Y		3,600	3,600	3,600	3,600	1,900	670		141.732 (Note 2)	141.732 (Note 2)	141.732 (Note 2)	141.732 (Note 2)	74.803	26.378		3,600	3,600	3,600	3,600	3,600	—	FT-H35-M2		3,600	3,600	3,600	3,600	3,300	1,400		141.732 (Note 2)	141.732 (Note 2)	141.732 (Note 2)	141.732 (Note 2)	129.921	55.118		3,600	3,600	3,600	3,600	3,600	—	FT-H20W-M1		1,600	1,600	1,600	1,600	1,600	850		62.992 (Note 2)	62.992 (Note 2)	62.992 (Note 2)	62.992 (Note 2)	62.992 (Note 2)	33.465		1,600	1,600	1,600	1,600	1,600	—	FT-H20-M1		1,600	1,600	1,600	1,600	1,600	1,200		62.992 (Note 2)	62.992 (Note 2)	62.992 (Note 2)	62.992 (Note 2)	62.992 (Note 2)	47.244		1,600	1,600	1,600	1,600	1,600	—	FT-H20-J50-S FT-H20-J30-S FT-H20-J20-S		3,600	3,600	3,500	2,000	1,600	500		141.732 (Note 2)	141.732 (Note 2)	137.795	78.740	62.992	19.685		3,600	3,600	3,600	3,600	3,600	—
		Amplifier		FX-500 series (Upper value) FX-550 / FX-550L series (Lower value)																																																																																																																																																																																																																			
		Fiber	Mode	HYPR	U-LG	LONG	STD	FAST	H-SP																																																																																																																																																																																																														
		FT-43		3,600	3,600	3,600	3,600	3,600	1,600																																																																																																																																																																																																														
				141.732 (Note 2)	141.732 (Note 2)	141.732 (Note 2)	141.732 (Note 2)	141.732 (Note 2)	62.992																																																																																																																																																																																																														
				3,600	3,600	3,600	3,600	3,600	—																																																																																																																																																																																																														
		FT-42 FT-42W		3,600	3,600	3,600	3,600	3,600	2,200																																																																																																																																																																																																														
				141.732 (Note 2)	141.732 (Note 2)	141.732 (Note 2)	141.732 (Note 2)	141.732 (Note 2)	86.614																																																																																																																																																																																																														
				3,600	3,600	3,600	3,600	3,600	—																																																																																																																																																																																																														
		FT-45X		1,600	1,600	1,600	1,600	1,600	1,500																																																																																																																																																																																																														
	62.992 (Note 2)		62.992 (Note 2)	62.992 (Note 2)	62.992 (Note 2)	62.992 (Note 2)	59.055																																																																																																																																																																																																																
	1,600		1,600	1,600	1,600	1,600	—																																																																																																																																																																																																																
FT-R40		3,600	3,600	3,600	3,600	3,600	1,900																																																																																																																																																																																																																
		141.732 (Note 2)	141.732 (Note 2)	141.732 (Note 2)	141.732 (Note 2)	141.732 (Note 2)	74.803																																																																																																																																																																																																																
		3,600	3,600	3,600	3,600	3,600	—																																																																																																																																																																																																																
FT-R43 FT-R44Y		3,600	3,600	3,600	3,600	1,900	670																																																																																																																																																																																																																
		141.732 (Note 2)	141.732 (Note 2)	141.732 (Note 2)	141.732 (Note 2)	74.803	26.378																																																																																																																																																																																																																
		3,600	3,600	3,600	3,600	3,600	—																																																																																																																																																																																																																
FT-H35-M2		3,600	3,600	3,600	3,600	3,300	1,400																																																																																																																																																																																																																
		141.732 (Note 2)	141.732 (Note 2)	141.732 (Note 2)	141.732 (Note 2)	129.921	55.118																																																																																																																																																																																																																
		3,600	3,600	3,600	3,600	3,600	—																																																																																																																																																																																																																
FT-H20W-M1		1,600	1,600	1,600	1,600	1,600	850																																																																																																																																																																																																																
		62.992 (Note 2)	62.992 (Note 2)	62.992 (Note 2)	62.992 (Note 2)	62.992 (Note 2)	33.465																																																																																																																																																																																																																
		1,600	1,600	1,600	1,600	1,600	—																																																																																																																																																																																																																
FT-H20-M1		1,600	1,600	1,600	1,600	1,600	1,200																																																																																																																																																																																																																
		62.992 (Note 2)	62.992 (Note 2)	62.992 (Note 2)	62.992 (Note 2)	62.992 (Note 2)	47.244																																																																																																																																																																																																																
		1,600	1,600	1,600	1,600	1,600	—																																																																																																																																																																																																																
FT-H20-J50-S FT-H20-J30-S FT-H20-J20-S		3,600	3,600	3,500	2,000	1,600	500																																																																																																																																																																																																																
		141.732 (Note 2)	141.732 (Note 2)	137.795	78.740	62.992	19.685																																																																																																																																																																																																																
		3,600	3,600	3,600	3,600	3,600	—																																																																																																																																																																																																																
Super-expansion lens (Note 1)	FX-LE2	<p>Tremendously increases the sensing range with large diameter lenses.</p> <p>• Ambient temperature: -60 to +350 °C -76 to +662 °F (Note 4) • Beam dia: ø9.8 mm ø0.386 in</p> <p>Sensing range (mm in) [Lens on both sides] (Note 3)</p> <table border="1"> <thead> <tr> <th colspan="2">Amplifier</th> <th colspan="5">FX-500 series (Upper value) FX-550 / FX-550L series (Lower value)</th> </tr> <tr> <th>Fiber</th> <th>Mode</th> <th>HYPR</th> <th>U-LG</th> <th>LONG</th> <th>STD</th> <th>FAST</th> <th>H-SP</th> </tr> </thead> <tbody> <tr> <td rowspan="3">FT-43 FT-42 FT-42W</td> <td></td> <td>3,600</td> <td>3,600</td> <td>3,600</td> <td>3,600</td> <td>3,600</td> <td>3,600</td> </tr> <tr> <td></td> <td>141.732 (Note 2)</td> <td>141.732 (Note 2)</td> <td>141.732 (Note 2)</td> <td>141.732 (Note 2)</td> <td>141.732 (Note 2)</td> <td>141.732 (Note 2)</td> </tr> <tr> <td></td> <td>3,600</td> <td>3,600</td> <td>3,600</td> <td>3,600</td> <td>3,600</td> <td>—</td> </tr> <tr> <td rowspan="3">FT-45X</td> <td></td> <td>1,600</td> <td>1,600</td> <td>1,600</td> <td>1,600</td> <td>1,600</td> <td>1,600</td> </tr> <tr> <td></td> <td>62.992 (Note 2)</td> <td>62.992 (Note 2)</td> <td>62.992 (Note 2)</td> <td>62.992 (Note 2)</td> <td>62.992 (Note 2)</td> <td>62.992 (Note 2)</td> </tr> <tr> <td></td> <td>1,600</td> <td>1,600</td> <td>1,600</td> <td>1,600</td> <td>1,600</td> <td>—</td> </tr> <tr> <td rowspan="3">FT-R40</td> <td></td> <td>3,600</td> <td>3,600</td> <td>3,600</td> <td>3,600</td> <td>3,600</td> <td>3,600</td> </tr> <tr> <td></td> <td>141.732 (Note 2)</td> <td>141.732 (Note 2)</td> <td>141.732 (Note 2)</td> <td>141.732 (Note 2)</td> <td>141.732 (Note 2)</td> <td>141.732 (Note 2)</td> </tr> <tr> <td></td> <td>3,600</td> <td>3,600</td> <td>3,600</td> <td>3,600</td> <td>3,600</td> <td>—</td> </tr> <tr> <td rowspan="3">FT-R41W FT-R43 FT-R44Y</td> <td></td> <td>3,600</td> <td>3,600</td> <td>3,600</td> <td>3,600</td> <td>3,600</td> <td>3,600</td> </tr> <tr> <td></td> <td>141.732 (Note 2)</td> <td>141.732 (Note 2)</td> <td>141.732 (Note 2)</td> <td>141.732 (Note 2)</td> <td>141.732 (Note 2)</td> <td>141.732 (Note 2)</td> </tr> <tr> <td></td> <td>3,600</td> <td>3,600</td> <td>3,600</td> <td>3,600</td> <td>3,600</td> <td>—</td> </tr> <tr> <td rowspan="3">FT-H35-M2</td> <td></td> <td>3,600</td> <td>3,600</td> <td>3,600</td> <td>3,600</td> <td>3,600</td> <td>3,600</td> </tr> <tr> <td></td> <td>141.732 (Note 2)</td> <td>141.732 (Note 2)</td> <td>141.732 (Note 2)</td> <td>141.732 (Note 2)</td> <td>141.732 (Note 2)</td> <td>141.732 (Note 2)</td> </tr> <tr> <td></td> <td>3,600</td> <td>3,600</td> <td>3,600</td> <td>3,600</td> <td>3,600</td> <td>—</td> </tr> <tr> <td rowspan="3">FT-H20W-M1 FT-H20-M1</td> <td></td> <td>1,600</td> <td>1,600</td> <td>1,600</td> <td>1,600</td> <td>1,600</td> <td>1,600</td> </tr> <tr> <td></td> <td>62.992 (Note 2)</td> <td>62.992 (Note 2)</td> <td>62.992 (Note 2)</td> <td>62.992 (Note 2)</td> <td>62.992 (Note 2)</td> <td>62.992 (Note 2)</td> </tr> <tr> <td></td> <td>1,600</td> <td>1,600</td> <td>1,600</td> <td>1,600</td> <td>1,600</td> <td>—</td> </tr> <tr> <td rowspan="3">FT-H13-FM2</td> <td></td> <td>3,600</td> <td>3,600</td> <td>3,600</td> <td>3,600</td> <td>3,600</td> <td>3,600</td> </tr> <tr> <td></td> <td>141.732 (Note 2)</td> <td>141.732 (Note 2)</td> <td>141.732 (Note 2)</td> <td>141.732 (Note 2)</td> <td>141.732 (Note 2)</td> <td>141.732 (Note 2)</td> </tr> <tr> <td></td> <td>3,600</td> <td>3,600</td> <td>3,600</td> <td>3,600</td> <td>3,600</td> <td>—</td> </tr> <tr> <td rowspan="3">FT-H20-J50-S FT-H20-J30-S FT-H20-J20-S</td> <td></td> <td>3,600</td> <td>3,600</td> <td>3,600</td> <td>3,600</td> <td>3,600</td> <td>3,600</td> </tr> <tr> <td></td> <td>141.732 (Note 2)</td> <td>141.732 (Note 2)</td> <td>141.732 (Note 2)</td> <td>141.732 (Note 2)</td> <td>141.732 (Note 2)</td> <td>141.732 (Note 2)</td> </tr> <tr> <td></td> <td>3,600</td> <td>3,600</td> <td>3,600</td> <td>3,600</td> <td>3,600</td> <td>—</td> </tr> </tbody> </table>	Amplifier		FX-500 series (Upper value) FX-550 / FX-550L series (Lower value)					Fiber	Mode	HYPR	U-LG	LONG	STD	FAST	H-SP	FT-43 FT-42 FT-42W		3,600	3,600	3,600	3,600	3,600	3,600		141.732 (Note 2)	141.732 (Note 2)	141.732 (Note 2)	141.732 (Note 2)	141.732 (Note 2)	141.732 (Note 2)		3,600	3,600	3,600	3,600	3,600	—	FT-45X		1,600	1,600	1,600	1,600	1,600	1,600		62.992 (Note 2)	62.992 (Note 2)	62.992 (Note 2)	62.992 (Note 2)	62.992 (Note 2)	62.992 (Note 2)		1,600	1,600	1,600	1,600	1,600	—	FT-R40		3,600	3,600	3,600	3,600	3,600	3,600		141.732 (Note 2)	141.732 (Note 2)	141.732 (Note 2)	141.732 (Note 2)	141.732 (Note 2)	141.732 (Note 2)		3,600	3,600	3,600	3,600	3,600	—	FT-R41W FT-R43 FT-R44Y		3,600	3,600	3,600	3,600	3,600	3,600		141.732 (Note 2)	141.732 (Note 2)	141.732 (Note 2)	141.732 (Note 2)	141.732 (Note 2)	141.732 (Note 2)		3,600	3,600	3,600	3,600	3,600	—	FT-H35-M2		3,600	3,600	3,600	3,600	3,600	3,600		141.732 (Note 2)	141.732 (Note 2)	141.732 (Note 2)	141.732 (Note 2)	141.732 (Note 2)	141.732 (Note 2)		3,600	3,600	3,600	3,600	3,600	—	FT-H20W-M1 FT-H20-M1		1,600	1,600	1,600	1,600	1,600	1,600		62.992 (Note 2)	62.992 (Note 2)	62.992 (Note 2)	62.992 (Note 2)	62.992 (Note 2)	62.992 (Note 2)		1,600	1,600	1,600	1,600	1,600	—	FT-H13-FM2		3,600	3,600	3,600	3,600	3,600	3,600		141.732 (Note 2)	141.732 (Note 2)	141.732 (Note 2)	141.732 (Note 2)	141.732 (Note 2)	141.732 (Note 2)		3,600	3,600	3,600	3,600	3,600	—	FT-H20-J50-S FT-H20-J30-S FT-H20-J20-S		3,600	3,600	3,600	3,600	3,600	3,600		141.732 (Note 2)	141.732 (Note 2)	141.732 (Note 2)	141.732 (Note 2)	141.732 (Note 2)	141.732 (Note 2)		3,600	3,600	3,600	3,600	3,600	—																						
		Amplifier		FX-500 series (Upper value) FX-550 / FX-550L series (Lower value)																																																																																																																																																																																																																			
		Fiber	Mode	HYPR	U-LG	LONG	STD	FAST	H-SP																																																																																																																																																																																																														
		FT-43 FT-42 FT-42W		3,600	3,600	3,600	3,600	3,600	3,600																																																																																																																																																																																																														
				141.732 (Note 2)	141.732 (Note 2)	141.732 (Note 2)	141.732 (Note 2)	141.732 (Note 2)	141.732 (Note 2)																																																																																																																																																																																																														
				3,600	3,600	3,600	3,600	3,600	—																																																																																																																																																																																																														
		FT-45X		1,600	1,600	1,600	1,600	1,600	1,600																																																																																																																																																																																																														
				62.992 (Note 2)	62.992 (Note 2)	62.992 (Note 2)	62.992 (Note 2)	62.992 (Note 2)	62.992 (Note 2)																																																																																																																																																																																																														
				1,600	1,600	1,600	1,600	1,600	—																																																																																																																																																																																																														
		FT-R40		3,600	3,600	3,600	3,600	3,600	3,600																																																																																																																																																																																																														
	141.732 (Note 2)		141.732 (Note 2)	141.732 (Note 2)	141.732 (Note 2)	141.732 (Note 2)	141.732 (Note 2)																																																																																																																																																																																																																
	3,600		3,600	3,600	3,600	3,600	—																																																																																																																																																																																																																
FT-R41W FT-R43 FT-R44Y		3,600	3,600	3,600	3,600	3,600	3,600																																																																																																																																																																																																																
		141.732 (Note 2)	141.732 (Note 2)	141.732 (Note 2)	141.732 (Note 2)	141.732 (Note 2)	141.732 (Note 2)																																																																																																																																																																																																																
		3,600	3,600	3,600	3,600	3,600	—																																																																																																																																																																																																																
FT-H35-M2		3,600	3,600	3,600	3,600	3,600	3,600																																																																																																																																																																																																																
		141.732 (Note 2)	141.732 (Note 2)	141.732 (Note 2)	141.732 (Note 2)	141.732 (Note 2)	141.732 (Note 2)																																																																																																																																																																																																																
		3,600	3,600	3,600	3,600	3,600	—																																																																																																																																																																																																																
FT-H20W-M1 FT-H20-M1		1,600	1,600	1,600	1,600	1,600	1,600																																																																																																																																																																																																																
		62.992 (Note 2)	62.992 (Note 2)	62.992 (Note 2)	62.992 (Note 2)	62.992 (Note 2)	62.992 (Note 2)																																																																																																																																																																																																																
		1,600	1,600	1,600	1,600	1,600	—																																																																																																																																																																																																																
FT-H13-FM2		3,600	3,600	3,600	3,600	3,600	3,600																																																																																																																																																																																																																
		141.732 (Note 2)	141.732 (Note 2)	141.732 (Note 2)	141.732 (Note 2)	141.732 (Note 2)	141.732 (Note 2)																																																																																																																																																																																																																
		3,600	3,600	3,600	3,600	3,600	—																																																																																																																																																																																																																
FT-H20-J50-S FT-H20-J30-S FT-H20-J20-S		3,600	3,600	3,600	3,600	3,600	3,600																																																																																																																																																																																																																
		141.732 (Note 2)	141.732 (Note 2)	141.732 (Note 2)	141.732 (Note 2)	141.732 (Note 2)	141.732 (Note 2)																																																																																																																																																																																																																
		3,600	3,600	3,600	3,600	3,600	—																																																																																																																																																																																																																

- Notes: 1) Be careful sure to use it only after you have adjusted it sufficiently when installing the thru-beam type fiber equipped with the expansion lens, as the beam envelope becomes narrow and alignment is difficult.
 2) The fiber cable length practically limits the sensing range.
 3) FX-550L series does not have FAST mode.
 4) Refer to LIST OF FIBERS (p.25~) for the ambient temperature of fibers to be used in combination.

FIBER OPTIONS



Lens (For thru-beam type fiber)

Designation		Model No.	Description									
For thru-beam type fiber	Side-view lens	FX-SV1		Beam axis is bent by 90°. • Ambient temperature: -60 to +300 °C -76 to +572 °F (Note 1) • Beam dia: ø2.8 mm ø0.110 in Sensing range (mm in) [Lens on both sides] (Note 3)								
				Amplifier		FX-500 series (Upper value)						
				Fiber Mode		FX-550 / FX-550L series (Lower value)						
						HYPR	U-LG	LONG	STD	FAST	H-SP	
				FT-43	3,600 141.732 (Note 2) 3,600 141.732 (Note 2)	3,400 133.858 3,600 141.732 (Note 2)	2,600 102.362 3,600 141.732 (Note 2)	1,700 66.929 2,300 90.551	970 38.189 1,400 55.118		310 12.205 —	
				FT-42	3,600 141.732 (Note 2) 3,600 141.732 (Note 2)	3,600 141.732 (Note 2) 3,600 141.732 (Note 2)	3,600 141.732 (Note 2) 3,600 141.732 (Note 2)	2,100 82.677 2,800 110.236	1,150 45.276 1,700 66.929		370 14.567 —	
				FT-42W	3,600 141.732 (Note 2) 3,600 141.732 (Note 2)	3,500 137.795 3,600 141.732 (Note 2)	2,700 106.299 3,600 141.732 (Note 2)	1,800 70.866 2,300 90.551	990 38.976 1,400 55.118		320 12.598 —	
				FT-45X	1,600 62.992 (Note 2) 1,600 62.992 (Note 2)	1,600 62.992 (Note 2) 1,600 62.992 (Note 2)	1,600 62.992 (Note 2) 1,600 62.992 (Note 2)	1,400 55.118 1,600 62.992 (Note 2)	800 31.496 1,600 62.992 (Note 2)		210 8.268 —	
				FT-R43	3,200 125.984 3,600 141.732 (Note 2)	1,800 70.866 3,600 141.732 (Note 2)	1,300 51.181 2,700 106.299	950 37.402 1,900 74.803	510 20.079 1,200 47.244		160 6.299 —	
				FT-R44Y	3,200 125.984 3,600 141.732 (Note 2)	1,800 70.866 3,600 141.732 (Note 2)	1,300 51.181 3,200 125.984	950 37.402 2,200 86.614	510 20.079 1,400 55.118		160 6.299 —	
				FT-H35-M2	3,500 137.795 3,600 141.732 (Note 2)	1,600 62.992 2,800 110.236	1,200 47.244 1,800 70.866	780 30.709 1,300 51.181	500 19.685 750 29.528		150 5.906 —	
				FT-H20W-M1	1,600 62.992 (Note 2) 1,600 62.992 (Note 2)	1,600 62.992 (Note 2) 1,600 62.992 (Note 2)	1,500 59.055 1,600 62.992 (Note 2)	950 37.402 1,250 49.213	560 22.047 690 27.165		190 7.480 —	
				FT-H20-M1	1,600 62.992 (Note 2) 1,600 62.992 (Note 2)	1,600 62.992 (Note 2) 1,600 62.992 (Note 2)	1,300 51.181 1,600 62.992 (Note 2)	780 30.709 1,600 62.992 (Note 2)	500 19.685 800 31.496		150 5.906 —	
				FT-H20-J50-S FT-H20-J30-S FT-H20-J20-S	1,600 62.992 (Note 2) 3,600 141.732 (Note 2)	960 37.795 2,400 94.488	740 29.134 1,500 59.055	450 17.717 1,100 43.307	290 11.417 680 26.771		80 3.150 —	

- Notes: 1) Refer to [LIST OF FIBERS](#) (p.25~) for the ambient temperature of fibers to be used in combination.
 2) The fiber cable length practically limits the sensing range.
 3) **FX-550L** series does not have FAST mode.

FIBER OPTIONS

Vacuum-resistant lens (For thru-beam type fiber)

Designation	Model No.	Description																																																																																			
For thru-beam type fiber	Vacuum-resistant expansion lens (Note 1)	FV-LE1	 <p>Increases the sensing range 4 times or more. • Ambient temperature: -60 to +350 °C -76 to +662 °F (Note 6) • Beam axis dia: \varnothing3.6 mm \varnothing0.142 in Sensing range (mm in) [Lens on both sides] (Note 3, 4, 5)</p> <table border="1"> <thead> <tr> <th rowspan="2">Fiber</th> <th rowspan="2">Mode</th> <th colspan="6">Amplifier</th> </tr> <tr> <th colspan="3">FX-500 series (Upper value)</th> <th colspan="3">FX-550 / FX-550L series (Lower value)</th> </tr> <tr> <th></th> <th></th> <th>HYPR</th> <th>U-LG</th> <th>LONG</th> <th>STD</th> <th>FAST</th> <th>H-SP</th> </tr> </thead> <tbody> <tr> <td rowspan="3">FT-40V</td> <td>1,800 (Note 2)</td> <td>1,800 (Note 2)</td> <td>1,800 (Note 2)</td> <td>1,800 (Note 2)</td> <td>1,500</td> <td>900</td> <td>370</td> </tr> <tr> <td>70.866</td> <td>70.866</td> <td>70.866</td> <td>70.866</td> <td>59.055</td> <td>35.433</td> <td>14.567</td> </tr> <tr> <td>1,800 (Note 2)</td> <td>1,800 (Note 2)</td> <td>1,800 (Note 2)</td> <td>1,800 (Note 2)</td> <td>1,800 (Note 2)</td> <td>1,650</td> <td>—</td> </tr> <tr> <td></td> <td>70.866</td> <td>70.866</td> <td>70.866</td> <td>70.866</td> <td>70.866</td> <td>64.961</td> <td>—</td> </tr> <tr> <td rowspan="3">FT-H30-M1V-S</td> <td>3,600</td> <td>3,600</td> <td>3,600</td> <td>3,400</td> <td>1,500</td> <td>900</td> <td>370</td> </tr> <tr> <td>141.732 (Note 2)</td> <td>141.732 (Note 2)</td> <td>133.858</td> <td>59.055</td> <td>35.433</td> <td>14.567</td> <td>—</td> </tr> <tr> <td>3,600</td> <td>3,600</td> <td>3,600</td> <td>2,500</td> <td>1,650</td> <td>—</td> <td>—</td> </tr> <tr> <td></td> <td>141.732 (Note 2)</td> <td>141.732 (Note 2)</td> <td>141.732 (Note 2)</td> <td>98.425</td> <td>64.961</td> <td>—</td> <td>—</td> </tr> </tbody> </table>	Fiber	Mode	Amplifier						FX-500 series (Upper value)			FX-550 / FX-550L series (Lower value)					HYPR	U-LG	LONG	STD	FAST	H-SP	FT-40V	1,800 (Note 2)	1,800 (Note 2)	1,800 (Note 2)	1,800 (Note 2)	1,500	900	370	70.866	70.866	70.866	70.866	59.055	35.433	14.567	1,800 (Note 2)	1,800 (Note 2)	1,800 (Note 2)	1,800 (Note 2)	1,800 (Note 2)	1,650	—		70.866	70.866	70.866	70.866	70.866	64.961	—	FT-H30-M1V-S	3,600	3,600	3,600	3,400	1,500	900	370	141.732 (Note 2)	141.732 (Note 2)	133.858	59.055	35.433	14.567	—	3,600	3,600	3,600	2,500	1,650	—	—		141.732 (Note 2)	141.732 (Note 2)	141.732 (Note 2)	98.425	64.961	—	—
	Fiber	Mode	Amplifier																																																																																		
			FX-500 series (Upper value)			FX-550 / FX-550L series (Lower value)																																																																															
		HYPR	U-LG	LONG	STD	FAST	H-SP																																																																														
FT-40V	1,800 (Note 2)	1,800 (Note 2)	1,800 (Note 2)	1,800 (Note 2)	1,500	900	370																																																																														
	70.866	70.866	70.866	70.866	59.055	35.433	14.567																																																																														
	1,800 (Note 2)	1,800 (Note 2)	1,800 (Note 2)	1,800 (Note 2)	1,800 (Note 2)	1,650	—																																																																														
	70.866	70.866	70.866	70.866	70.866	64.961	—																																																																														
FT-H30-M1V-S	3,600	3,600	3,600	3,400	1,500	900	370																																																																														
	141.732 (Note 2)	141.732 (Note 2)	133.858	59.055	35.433	14.567	—																																																																														
	3,600	3,600	3,600	2,500	1,650	—	—																																																																														
	141.732 (Note 2)	141.732 (Note 2)	141.732 (Note 2)	98.425	64.961	—	—																																																																														
Vacuum-resistant compact side-view lens (Note 1)	FV-SV1	 <p>Beam axis is bent by 90°. • Ambient temperature: -30 to +300 °C -22 to +572 °F (Note 6) • Beam axis dia: \varnothing3 mm \varnothing0.118 in Sensing range (mm in) [Lens on both sides] (Note 3, 4)</p> <table border="1"> <thead> <tr> <th rowspan="2">Fiber</th> <th rowspan="2">Mode</th> <th colspan="6">Amplifier</th> </tr> <tr> <th colspan="3">FX-500 series (Upper value)</th> <th colspan="3">FX-550 / FX-550L series (Lower value)</th> </tr> <tr> <th></th> <th></th> <th>HYPR</th> <th>U-LG</th> <th>LONG</th> <th>STD</th> <th>FAST</th> <th>H-SP</th> </tr> </thead> <tbody> <tr> <td rowspan="3">FT-40V</td> <td>1,800 (Note 2)</td> <td>900</td> <td>700</td> <td>450</td> <td>290</td> <td>90</td> <td>—</td> </tr> <tr> <td>70.866</td> <td>35.433</td> <td>27.559</td> <td>17.717</td> <td>11.417</td> <td>3.543</td> <td>—</td> </tr> <tr> <td>1,800 (Note 2)</td> <td>1,800 (Note 2)</td> <td>1,050</td> <td>720</td> <td>430</td> <td>—</td> <td>—</td> </tr> <tr> <td></td> <td>70.866</td> <td>70.866</td> <td>41.339</td> <td>28.346</td> <td>16.929</td> <td>—</td> <td>—</td> </tr> </tbody> </table>	Fiber	Mode	Amplifier						FX-500 series (Upper value)			FX-550 / FX-550L series (Lower value)					HYPR	U-LG	LONG	STD	FAST	H-SP	FT-40V	1,800 (Note 2)	900	700	450	290	90	—	70.866	35.433	27.559	17.717	11.417	3.543	—	1,800 (Note 2)	1,800 (Note 2)	1,050	720	430	—	—		70.866	70.866	41.339	28.346	16.929	—	—																															
Fiber	Mode	Amplifier																																																																																			
		FX-500 series (Upper value)			FX-550 / FX-550L series (Lower value)																																																																																
		HYPR	U-LG	LONG	STD	FAST	H-SP																																																																														
FT-40V	1,800 (Note 2)	900	700	450	290	90	—																																																																														
	70.866	35.433	27.559	17.717	11.417	3.543	—																																																																														
	1,800 (Note 2)	1,800 (Note 2)	1,050	720	430	—	—																																																																														
	70.866	70.866	41.339	28.346	16.929	—	—																																																																														
Vacuum-resistant side-view lens (Note 1)	FV-SV2	 <p>Beam axis is bent by 90°. • Ambient temperature: -60 to +300 °C -76 to +572 °F (Note 6) • Beam axis dia: \varnothing3.7 mm \varnothing0.146 in Sensing range (mm in) [Lens on both sides] (Note 3, 4, 5)</p> <table border="1"> <thead> <tr> <th rowspan="2">Fiber</th> <th rowspan="2">Mode</th> <th colspan="6">Amplifier</th> </tr> <tr> <th colspan="3">FX-500 series (Upper value)</th> <th colspan="3">FX-550 / FX-550L series (Lower value)</th> </tr> <tr> <th></th> <th></th> <th>HYPR</th> <th>U-LG</th> <th>LONG</th> <th>STD</th> <th>FAST</th> <th>H-SP</th> </tr> </thead> <tbody> <tr> <td rowspan="3">FT-40V</td> <td>1,800 (Note 2)</td> <td>1,800 (Note 2)</td> <td>1,800 (Note 2)</td> <td>1,800 (Note 2)</td> <td>1,500</td> <td>900</td> <td>370</td> </tr> <tr> <td>70.866</td> <td>70.866</td> <td>70.866</td> <td>70.866</td> <td>59.055</td> <td>35.433</td> <td>14.567</td> </tr> <tr> <td>1,800 (Note 2)</td> <td>1,800 (Note 2)</td> <td>1,800 (Note 2)</td> <td>1,800 (Note 2)</td> <td>1,800 (Note 2)</td> <td>1,100</td> <td>—</td> </tr> <tr> <td></td> <td>70.866</td> <td>70.866</td> <td>70.866</td> <td>70.866</td> <td>70.866</td> <td>43.307</td> <td>—</td> </tr> <tr> <td rowspan="3">FT-H30-M1V-S</td> <td>3,600</td> <td>3,600</td> <td>3,400</td> <td>1,500</td> <td>900</td> <td>370</td> <td>—</td> </tr> <tr> <td>141.732 (Note 2)</td> <td>141.732 (Note 2)</td> <td>133.858</td> <td>59.055</td> <td>35.433</td> <td>14.567</td> <td>—</td> </tr> <tr> <td>3,600</td> <td>3,600</td> <td>3,600</td> <td>1,800</td> <td>1,100</td> <td>—</td> <td>—</td> </tr> <tr> <td></td> <td>141.732 (Note 2)</td> <td>141.732 (Note 2)</td> <td>141.732 (Note 2)</td> <td>70.866</td> <td>43.307</td> <td>—</td> <td>—</td> </tr> </tbody> </table>	Fiber	Mode	Amplifier						FX-500 series (Upper value)			FX-550 / FX-550L series (Lower value)					HYPR	U-LG	LONG	STD	FAST	H-SP	FT-40V	1,800 (Note 2)	1,800 (Note 2)	1,800 (Note 2)	1,800 (Note 2)	1,500	900	370	70.866	70.866	70.866	70.866	59.055	35.433	14.567	1,800 (Note 2)	1,800 (Note 2)	1,800 (Note 2)	1,800 (Note 2)	1,800 (Note 2)	1,100	—		70.866	70.866	70.866	70.866	70.866	43.307	—	FT-H30-M1V-S	3,600	3,600	3,400	1,500	900	370	—	141.732 (Note 2)	141.732 (Note 2)	133.858	59.055	35.433	14.567	—	3,600	3,600	3,600	1,800	1,100	—	—		141.732 (Note 2)	141.732 (Note 2)	141.732 (Note 2)	70.866	43.307	—	—	
Fiber	Mode	Amplifier																																																																																			
		FX-500 series (Upper value)			FX-550 / FX-550L series (Lower value)																																																																																
		HYPR	U-LG	LONG	STD	FAST	H-SP																																																																														
FT-40V	1,800 (Note 2)	1,800 (Note 2)	1,800 (Note 2)	1,800 (Note 2)	1,500	900	370																																																																														
	70.866	70.866	70.866	70.866	59.055	35.433	14.567																																																																														
	1,800 (Note 2)	1,800 (Note 2)	1,800 (Note 2)	1,800 (Note 2)	1,800 (Note 2)	1,100	—																																																																														
	70.866	70.866	70.866	70.866	70.866	43.307	—																																																																														
FT-H30-M1V-S	3,600	3,600	3,400	1,500	900	370	—																																																																														
	141.732 (Note 2)	141.732 (Note 2)	133.858	59.055	35.433	14.567	—																																																																														
	3,600	3,600	3,600	1,800	1,100	—	—																																																																														
	141.732 (Note 2)	141.732 (Note 2)	141.732 (Note 2)	70.866	43.307	—	—																																																																														

- Notes: 1) Be careful when installing the thru-beam type fiber equipped with the lens, as the beam envelope becomes narrow and alignment is difficult.
 2) The fiber cable length practically limits the sensing range.
 3) **FX-550L** series does not have FAST mode.
 4) The fiber cable length for the **FT-40V** is 1 m **3.281 ft**. The sensing ranges take into account the length of the **FT-J9** atmospheric side fiber.
 5) The fiber cable length for the **FT-H30-M1V-S** is 1 m **3.281 ft**. The sensing ranges in HYPR, U-LG and LONG of **FX-500 / FX-550 / FX-550L** series are specified considering the length of the **FT-J8** atmospheric side fiber.
 6) Refer to **LIST OF FIBERS** (p.25~) for the ambient temperature of fibers to be used in combination.

FIBER OPTIONS

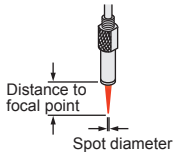
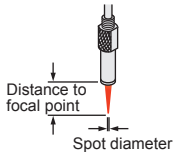
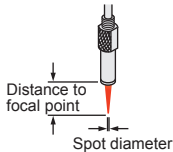
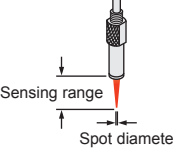

Lens (For reflective type fiber)

Designation	Model No.	Description														
For reflective type fiber	Finest spot lens		<p>Extremely fine spot of $\varnothing 0.1$ mm $\varnothing 0.004$ in approx. achieved.</p> <ul style="list-style-type: none"> Applicable fibers: FD-R33EG, FD-EG31, FD-R34EG, FD-R32EG, FD-EG30, FD-R31G, FD-42G, FD-42GW, FD-32G, FD-32GX Ambient temperature: -55 to $+70$ °C $+67$ to $+158$ °F (Note) 	<p>Sensing range for FX-500 / FX-550 / FX-550L series</p> <table border="1"> <thead> <tr> <th>Fiber model No.</th> <th>Distance to focal point</th> <th>Spot diameter</th> </tr> </thead> <tbody> <tr> <td>FD-R33EG FD-EG31</td> <td rowspan="5">7 \pm 0.5 mm 0.276 \pm 0.020 in</td> <td>$\varnothing 0.1$ mm approx. $\varnothing 0.004$ in approx.</td> </tr> <tr> <td>FD-R34EG</td> <td>$\varnothing 0.15$ mm approx. $\varnothing 0.006$ in approx.</td> </tr> <tr> <td>FD-R32EG FD-EG30</td> <td>$\varnothing 0.2$ mm approx. $\varnothing 0.008$ in approx.</td> </tr> <tr> <td>FD-R31G FD-42G/42GW FD-32G/32GX</td> <td>$\varnothing 0.4$ mm approx. $\varnothing 0.016$ in approx.</td> </tr> </tbody> </table>	Fiber model No.	Distance to focal point	Spot diameter	FD-R33EG FD-EG31	7 \pm 0.5 mm 0.276 \pm 0.020 in	$\varnothing 0.1$ mm approx. $\varnothing 0.004$ in approx.	FD-R34EG	$\varnothing 0.15$ mm approx. $\varnothing 0.006$ in approx.	FD-R32EG FD-EG30	$\varnothing 0.2$ mm approx. $\varnothing 0.008$ in approx.	FD-R31G FD-42G/42GW FD-32G/32GX	$\varnothing 0.4$ mm approx. $\varnothing 0.016$ in approx.
		Fiber model No.	Distance to focal point	Spot diameter												
		FD-R33EG FD-EG31	7 \pm 0.5 mm 0.276 \pm 0.020 in	$\varnothing 0.1$ mm approx. $\varnothing 0.004$ in approx.												
FD-R34EG	$\varnothing 0.15$ mm approx. $\varnothing 0.006$ in approx.															
FD-R32EG FD-EG30	$\varnothing 0.2$ mm approx. $\varnothing 0.008$ in approx.															
FD-R31G FD-42G/42GW FD-32G/32GX	$\varnothing 0.4$ mm approx. $\varnothing 0.016$ in approx.															
	<p>Extremely fine spot of $\varnothing 0.1$ mm $\varnothing 0.004$ in approx. achieved.</p> <ul style="list-style-type: none"> Applicable fibers: FD-R33EG, FD-EG31, FD-R34EG, FD-R32EG, FD-EG30, FD-R31G, FD-42G, FD-42GW, FD-32G, FD-32GX Ambient temperature: -20 to $+60$ °C -4 to $+140$ °F (Note) 	<p>Sensing range for FX-500 / FX-550 / FX-550L series</p> <table border="1"> <thead> <tr> <th>Fiber model No.</th> <th>Distance to focal point</th> <th>Spot diameter</th> </tr> </thead> <tbody> <tr> <td>FD-R33EG FD-EG31</td> <td rowspan="5">7 \pm 0.5 mm 0.276 \pm 0.020 in</td> <td>$\varnothing 0.1$ mm approx. $\varnothing 0.004$ in approx.</td> </tr> <tr> <td>FD-R34EG</td> <td>$\varnothing 0.15$ mm approx. $\varnothing 0.006$ in approx.</td> </tr> <tr> <td>FD-R32EG FD-EG30</td> <td>$\varnothing 0.2$ mm approx. $\varnothing 0.008$ in approx.</td> </tr> <tr> <td>FD-R31G FD-42G/42GW FD-32G/32GX</td> <td>$\varnothing 0.4$ mm approx. $\varnothing 0.016$ in approx.</td> </tr> </tbody> </table>		Fiber model No.	Distance to focal point	Spot diameter	FD-R33EG FD-EG31	7 \pm 0.5 mm 0.276 \pm 0.020 in	$\varnothing 0.1$ mm approx. $\varnothing 0.004$ in approx.	FD-R34EG	$\varnothing 0.15$ mm approx. $\varnothing 0.006$ in approx.	FD-R32EG FD-EG30	$\varnothing 0.2$ mm approx. $\varnothing 0.008$ in approx.	FD-R31G FD-42G/42GW FD-32G/32GX	$\varnothing 0.4$ mm approx. $\varnothing 0.016$ in approx.	
Fiber model No.	Distance to focal point	Spot diameter														
FD-R33EG FD-EG31	7 \pm 0.5 mm 0.276 \pm 0.020 in	$\varnothing 0.1$ mm approx. $\varnothing 0.004$ in approx.														
FD-R34EG		$\varnothing 0.15$ mm approx. $\varnothing 0.006$ in approx.														
FD-R32EG FD-EG30		$\varnothing 0.2$ mm approx. $\varnothing 0.008$ in approx.														
FD-R31G FD-42G/42GW FD-32G/32GX		$\varnothing 0.4$ mm approx. $\varnothing 0.016$ in approx.														
		<p>Extremely fine spot of $\varnothing 0.15$ mm $\varnothing 0.006$ in approx. achieved.</p> <ul style="list-style-type: none"> Applicable fibers: FD-R33EG, FD-EG31, FD-R34EG, FD-R32EG, FD-EG30, FD-R31G, FD-42G, FD-42GW, FD-32G, FD-32GX Ambient temperature: -40 to $+70$ °C -40 to $+158$ °F (Note) 	<p>Sensing range for FX-500 / FX-550 / FX-550L series</p> <table border="1"> <thead> <tr> <th>Fiber model No.</th> <th>Distance to focal point</th> <th>Spot diameter</th> </tr> </thead> <tbody> <tr> <td>FD-R33EG FD-EG31</td> <td rowspan="5">7.5 \pm 0.5 mm 0.295 \pm 0.020 in</td> <td>$\varnothing 0.15$ mm approx. $\varnothing 0.006$ in approx.</td> </tr> <tr> <td>FD-R34EG</td> <td>$\varnothing 0.2$ mm approx. $\varnothing 0.008$ in approx.</td> </tr> <tr> <td>FD-R32EG FD-EG30</td> <td>$\varnothing 0.3$ mm approx. $\varnothing 0.012$ in approx.</td> </tr> <tr> <td>FD-R31G FD-42G/42GW FD-32G/32GX</td> <td>$\varnothing 0.5$ mm approx. $\varnothing 0.020$ in approx.</td> </tr> </tbody> </table>	Fiber model No.	Distance to focal point	Spot diameter	FD-R33EG FD-EG31	7.5 \pm 0.5 mm 0.295 \pm 0.020 in	$\varnothing 0.15$ mm approx. $\varnothing 0.006$ in approx.	FD-R34EG	$\varnothing 0.2$ mm approx. $\varnothing 0.008$ in approx.	FD-R32EG FD-EG30	$\varnothing 0.3$ mm approx. $\varnothing 0.012$ in approx.	FD-R31G FD-42G/42GW FD-32G/32GX	$\varnothing 0.5$ mm approx. $\varnothing 0.020$ in approx.	
Fiber model No.	Distance to focal point	Spot diameter														
FD-R33EG FD-EG31	7.5 \pm 0.5 mm 0.295 \pm 0.020 in	$\varnothing 0.15$ mm approx. $\varnothing 0.006$ in approx.														
FD-R34EG		$\varnothing 0.2$ mm approx. $\varnothing 0.008$ in approx.														
FD-R32EG FD-EG30		$\varnothing 0.3$ mm approx. $\varnothing 0.012$ in approx.														
FD-R31G FD-42G/42GW FD-32G/32GX		$\varnothing 0.5$ mm approx. $\varnothing 0.020$ in approx.														
Zoom lens			<p>The spot diameter is adjustable according to how much the fiber is screwed in.</p> <ul style="list-style-type: none"> Applicable fibers: FD-R33EG, FD-EG31, FD-R34EG, FD-R32EG, FD-EG30, FD-R31G, FD-32G, FD-32GX Ambient temperature: -55 to $+70$ °C $+67$ to $+158$ °F (Note) 	<p>Sensing range for FX-500 / FX-550 / FX-550L series</p> <table border="1"> <thead> <tr> <th>Fiber model No.</th> <th>Sensing range</th> <th>Spot diameter</th> </tr> </thead> <tbody> <tr> <td>FD-R33EG FD-EG31</td> <td rowspan="5">10 to 30 mm 0.394 to 1.181 in</td> <td>$\varnothing 0.4$ to $\varnothing 2.0$ mm approx. $\varnothing 0.016$ to $\varnothing 0.079$ in approx.</td> </tr> <tr> <td>FD-R34EG</td> <td>$\varnothing 0.4$ to $\varnothing 2.2$ mm approx. $\varnothing 0.016$ to $\varnothing 0.087$ in approx.</td> </tr> <tr> <td>FD-R32EG FD-EG30</td> <td>$\varnothing 0.5$ to $\varnothing 2.5$ mm approx. $\varnothing 0.020$ to $\varnothing 0.098$ in approx.</td> </tr> <tr> <td>FD-R31G FD-32G/32GX</td> <td>$\varnothing 0.8$ to $\varnothing 3.5$ mm approx. $\varnothing 0.031$ to $\varnothing 0.138$ in approx.</td> </tr> </tbody> </table>	Fiber model No.	Sensing range	Spot diameter	FD-R33EG FD-EG31	10 to 30 mm 0.394 to 1.181 in	$\varnothing 0.4$ to $\varnothing 2.0$ mm approx. $\varnothing 0.016$ to $\varnothing 0.079$ in approx.	FD-R34EG	$\varnothing 0.4$ to $\varnothing 2.2$ mm approx. $\varnothing 0.016$ to $\varnothing 0.087$ in approx.	FD-R32EG FD-EG30	$\varnothing 0.5$ to $\varnothing 2.5$ mm approx. $\varnothing 0.020$ to $\varnothing 0.098$ in approx.	FD-R31G FD-32G/32GX	$\varnothing 0.8$ to $\varnothing 3.5$ mm approx. $\varnothing 0.031$ to $\varnothing 0.138$ in approx.
Fiber model No.	Sensing range	Spot diameter														
FD-R33EG FD-EG31	10 to 30 mm 0.394 to 1.181 in	$\varnothing 0.4$ to $\varnothing 2.0$ mm approx. $\varnothing 0.016$ to $\varnothing 0.079$ in approx.														
FD-R34EG		$\varnothing 0.4$ to $\varnothing 2.2$ mm approx. $\varnothing 0.016$ to $\varnothing 0.087$ in approx.														
FD-R32EG FD-EG30		$\varnothing 0.5$ to $\varnothing 2.5$ mm approx. $\varnothing 0.020$ to $\varnothing 0.098$ in approx.														
FD-R31G FD-32G/32GX		$\varnothing 0.8$ to $\varnothing 3.5$ mm approx. $\varnothing 0.031$ to $\varnothing 0.138$ in approx.														

Note: Refer to LIST OF FIBERS (p.25~) for the ambient temperature of fibers to be used in combination.

FIBER OPTIONS

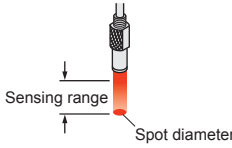
Lens (For reflective type fiber)

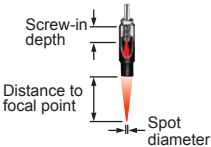
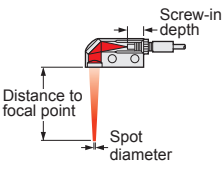
Designation	Model No.	Description														
For reflective type fiber	Parallel light lens	FX-MR9	 <p>Long-range parallel light</p> <ul style="list-style-type: none"> Applicable fibers: FD-R33EG, FD-EG31, FD-R34EG, FD-R32EG, FD-EG30, FD-R31G, FD-42G, FD-42GW, FD-32G, FD-32GX Ambient temperature: -55 to +70 °C +67 to +158 °F (Note) 	Sensing range for FX-500 / FX-550 / FX-550L series <table border="1"> <thead> <tr> <th>Fiber model No.</th> <th>Sensing range</th> <th>Spot diameter</th> </tr> </thead> <tbody> <tr> <td>FD-R33EG FD-EG31</td> <td rowspan="4">0 to 30 mm 0.394 to 1.181 in</td> <td rowspan="4">ø4.0 mm approx. ø0.157 in approx.</td> </tr> <tr> <td>FD-R34EG</td> </tr> <tr> <td>FD-R32EG FD-EG30</td> </tr> <tr> <td>FD-R31G FD-42G/42GW FD-32G/32GX</td> </tr> </tbody> </table>		Fiber model No.	Sensing range	Spot diameter	FD-R33EG FD-EG31	0 to 30 mm 0.394 to 1.181 in	ø4.0 mm approx. ø0.157 in approx.	FD-R34EG	FD-R32EG FD-EG30	FD-R31G FD-42G/42GW FD-32G/32GX		
	Fiber model No.	Sensing range	Spot diameter													
	FD-R33EG FD-EG31	0 to 30 mm 0.394 to 1.181 in	ø4.0 mm approx. ø0.157 in approx.													
	FD-R34EG															
FD-R32EG FD-EG30																
FD-R31G FD-42G/42GW FD-32G/32GX																
Pinpoint spot lens	FX-MR1	 <p>Pinpoint spot of ø0.5 mm ø0.020 in. Enables detection of minute objects or small marks.</p> <ul style="list-style-type: none"> Distance to focal point: 6 ± 1 mm 0.236 ± 0.039 in Applicable fibers: FD-42G, FD-42GW Ambient temperature: -40 to +70 °C -40 to +158 °F (Note) 														
Zoom lens	FX-MR2	 <p>The spot diameter is adjustable from ø0.7 to ø2 mm ø0.028 to ø0.079 in according to how much the fiber is screwed in.</p> <ul style="list-style-type: none"> Applicable fibers: FD-42G, FD-42GW Ambient temperature: -40 to +70 °C -40 to +158 °F (Note) Accessory: MS-EX3 (mounting bracket) 	Sensing range for FX-500 / FX-550 / FX-550L series <table border="1"> <thead> <tr> <th>Screw-in depth</th> <th>Distance to focal point</th> <th>Spot diameter</th> </tr> </thead> <tbody> <tr> <td>7 mm 0.276 in</td> <td>18.5 mm approx. 0.728 in approx.</td> <td>ø0.7 mm approx. ø0.028 in approx.</td> </tr> <tr> <td>12 mm 0.472 in</td> <td>27 mm approx. 1.063 in approx.</td> <td>ø1.2 mm approx. ø0.047 in approx.</td> </tr> <tr> <td>14 mm 0.551 in</td> <td>43 mm approx. 1.693 in approx.</td> <td>ø2.0 mm approx. ø0.079 in approx.</td> </tr> </tbody> </table>		Screw-in depth	Distance to focal point	Spot diameter	7 mm 0.276 in	18.5 mm approx. 0.728 in approx.	ø0.7 mm approx. ø0.028 in approx.	12 mm 0.472 in	27 mm approx. 1.063 in approx.	ø1.2 mm approx. ø0.047 in approx.	14 mm 0.551 in	43 mm approx. 1.693 in approx.	ø2.0 mm approx. ø0.079 in approx.
Screw-in depth	Distance to focal point	Spot diameter														
7 mm 0.276 in	18.5 mm approx. 0.728 in approx.	ø0.7 mm approx. ø0.028 in approx.														
12 mm 0.472 in	27 mm approx. 1.063 in approx.	ø1.2 mm approx. ø0.047 in approx.														
14 mm 0.551 in	43 mm approx. 1.693 in approx.	ø2.0 mm approx. ø0.079 in approx.														
Zoom lens (side-view type)	FX-MR5	 <p>FX-MR2 is converted into a side-view type and can be mounted in a very small space.</p> <ul style="list-style-type: none"> Applicable fibers: FD-42G, FD-42GW Ambient temperature: -40 to +60 °C -40 to +140 °F (Note) 	Sensing range for FX-500 / FX-550 / FX-550L series <table border="1"> <thead> <tr> <th>Screw-in depth</th> <th>Distance to focal point</th> <th>Spot diameter</th> </tr> </thead> <tbody> <tr> <td>8 mm 0.315 in</td> <td>13 mm approx. 0.512 in approx.</td> <td>ø0.5 mm approx. ø0.020 in approx.</td> </tr> <tr> <td>10 mm 0.394 in</td> <td>15 mm approx. 0.591 in approx.</td> <td>ø0.8 mm approx. ø0.031 in approx.</td> </tr> <tr> <td>14 mm 0.551 in</td> <td>30 mm approx. 1.181 in approx.</td> <td>ø3.0 mm approx. ø0.118 in approx.</td> </tr> </tbody> </table>		Screw-in depth	Distance to focal point	Spot diameter	8 mm 0.315 in	13 mm approx. 0.512 in approx.	ø0.5 mm approx. ø0.020 in approx.	10 mm 0.394 in	15 mm approx. 0.591 in approx.	ø0.8 mm approx. ø0.031 in approx.	14 mm 0.551 in	30 mm approx. 1.181 in approx.	ø3.0 mm approx. ø0.118 in approx.
Screw-in depth	Distance to focal point	Spot diameter														
8 mm 0.315 in	13 mm approx. 0.512 in approx.	ø0.5 mm approx. ø0.020 in approx.														
10 mm 0.394 in	15 mm approx. 0.591 in approx.	ø0.8 mm approx. ø0.031 in approx.														
14 mm 0.551 in	30 mm approx. 1.181 in approx.	ø3.0 mm approx. ø0.118 in approx.														

Note: Refer to [LIST OF FIBERS](#) (p.25~) for the ambient temperature of fibers to be used in combination.

FIBER OPTIONS

Others

Designation	Model No.	Description		
Protective tube for thru-beam type fiber	FTP-500 (0.5 m 1.640 ft)	For M4 thread	FT-42 FT-42S FT-42W	
	FTP-1000 (1 m 3.281 ft)		FT-43 FT-H13-FM2	
	FTP-1500 (1.5 m 4.921 ft)			
	Protective tube for reflective type fiber	FTP-N500 (0.5 m 1.640 ft)	For M3 thread	FT-31 FT-31S FT-31W
		FTP-N1000 (1 m 3.281 ft)		FD-31 FD-31W
		FTP-N1500 (1.5 m 4.921 ft)		
Protective tube for reflective type fiber	FDP-500 (0.5 m 1.640 ft)	For M6 thread	FD-61 FD-61G FD-61S FD-61W	
	FDP-1000 (1 m 3.281 ft)		FD-62 FD-H13-FM2	
	FDP-1500 (1.5 m 4.921 ft)			
	Fiber bender	FDP-N500 (0.5 m 1.640 ft)	For M4 thread	FD-41 FD-41W
		FDP-N1000 (1 m 3.281 ft)		FD-41S FD-41SW
		FDP-N1500 (1.5 m 4.921 ft)		
Fiber bender	FB-1	The fiber bender bends the sleeve part of the fiber head at the proper radius. (Note 1)		
Universal sensor mounting stand	MS-AJ1-F	Horizontal mounting type	Mounting stand assembly for fiber (For M3, M4 or M6 threaded head fiber)	
	MS-AJ2-F	Vertical mounting type		
Liquid inflow prevention joint (Note 2)	MS-FX-01Y	Applicable fibers	FD-HF40Y FD-F41Y	
Protective tube extension joint (Note 2)	MS-FX-02Y			The protective tube can be extended.
Fiber mounting joint (Note 2)	MS-FX-03Y			The joint is used for mounting fibers on a tank.
Single core holder	FX-AT15A	The incident light intensity may vary when using a multi-core fiber or a thin type sharp bending fiber. This holder suppresses the variation in the incident light intensity. (Brown)		
Reflector	RF-210	Used with FR-Z50HW.		
	RF-220	Refer to p.38 for the sensing range of FR-Z50HW to be used in combination.		
	RF-230			

Notes: 1) Do not bend the sleeve part of any side-view type fiber or ultra-small diameter head type fiber.
 2) The joint internal ferrule (MS-FX-YF) is available as a spare part. A distorted ferrule may result in leakage.

Liquid inflow prevention joint

- MS-FX-01Y

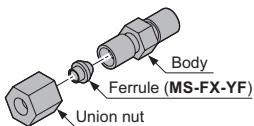

Protective tube extension joint

- MS-FX-02Y

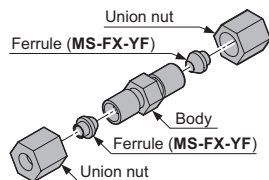

Fiber mounting joint

- MS-FX-03Y

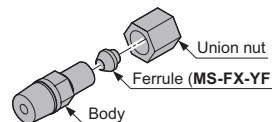

Reflector

- RF-210

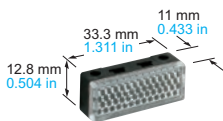

- RF-220

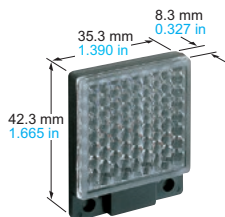

- RF-230

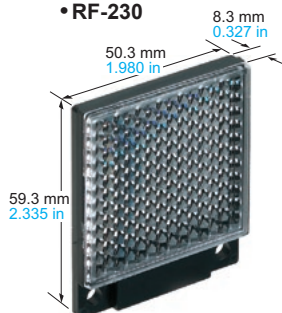

Protective tube

- FTP-□
- FDP-□

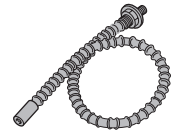

Fiber bender

- FB-1

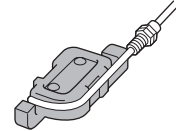

Universal sensor mounting stand

Using the arm which enables adjustment in the horizontal direction, sensing can also be done from above an assembly line.

- MS-AJ1-F

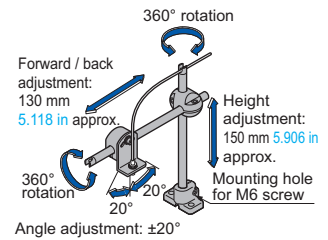

- MS-AJ2-F

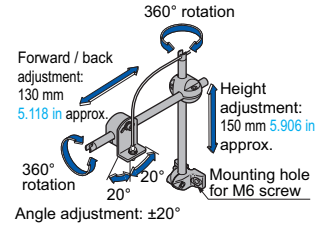

Single core holder

- FX-AT15A



FIBER OPTIONS

Model No. when ordering heat-resistant fibers individually as spare parts

- Heat-resistant side fiber
FT-H20-J20 (one pair set)
FT-H20-J30 (one pair set)
FT-H20-J50 (one pair set)
FT-H20-VJ50 (one pair set)
FT-H20-VJ80 (one pair set)
- Ordinary temperature side fiber
FT-42 (one pair set)

Model No. when ordering vacuum-resistant fibers individually as spare parts

- Vacuum-resistant fiber
FT-H30-M1V (one pair set)
FD-H30-KZ1V
FD-H30-L32V
- Photo-terminal
FV-BR1 (one pair set)
- Fiber at atmospheric side
FT-J8 (one pair set)

- Mounting bracket for **FD-KZ50V / FD-H30-KZ1V(-S)**
MS-FD-2

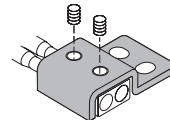

Model No. when ordering accessories additionally

- **RF-003** (Reflector for **FR-KZ50E/KZ50H**)
- **RF-13** (Reflective tape for **FR-Z50HW**)
- **FX-CT2** (Fiber cutter)
- **FX-CT3** (Fiber cutter for $\varnothing 1\text{mm } \varnothing 0.039\text{ in}$ / $\varnothing 1.3\text{mm } \varnothing 0.051\text{ in}$ fiber cable / $\varnothing 4\text{mm } \varnothing 0.157\text{ in}$ protective tube)
- **FX-CT4** (Fiber cutter for $\varnothing 2\text{mm } \varnothing 0.079\text{ in}$ fiber cable / $\varnothing 4\text{mm } \varnothing 0.157\text{ in}$ protective tube)
- **FX-AT2** (Attachment for fixed-length fiber, Orange)
- **FX-AT3** (Attachment for $\varnothing 2.2\text{ mm } \varnothing 0.087\text{ in}$ fiber, Clear orange)
- **FX-AT4** (Attachment for $\varnothing 1\text{ mm } \varnothing 0.039\text{ in}$ fiber, Black)
- **FX-AT5** (Attachment for $\varnothing 1.3\text{ mm } \varnothing 0.051\text{ in}$ fiber, Gray)
- **FX-AT6** (Attachment for $\varnothing 1\text{ mm } \varnothing 0.039\text{ in}$ / $\varnothing 1.3\text{ mm } \varnothing 0.051\text{ in}$ mixed fiber, Black / Gray)
- **FX-AT4G1** (Gland single for $\varnothing 1\text{ mm } \varnothing 0.039\text{ in}$ fiber, Black)
- **FX-AT5G1** (Gland single for $\varnothing 1.3\text{ mm } \varnothing 0.051\text{ in}$ fiber, Gray)
- **FX-AT6G1** (Gland single for $\varnothing 1\text{ mm } \varnothing 0.039\text{ in}$ / $\varnothing 1.3\text{ mm } \varnothing 0.051\text{ in}$ mixed fiber, Black / Gray)
- **FX-SL1** (Slit mask for **FT-A11 / FT-A11W** (one pair set), slit size: $0.5 \times 12\text{ mm } 0.020 \times 0.472\text{ in}$)
- **FX-SL2** (Slit mask for **FT-A11 / FT-A11W** (one pair set), slit size: $1 \times 12\text{ mm } 0.039 \times 0.472\text{ in}$)
- **FX-SL3** (Slit mask for **FT-A32 / FT-A32W** (one pair set), slit size: $0.5 \times 33\text{ mm } 0.020 \times 1.299\text{ in}$)
- **MS-FD-2** (Fiber mounting bracket)
- **MS-FD-F7-1** (SUS mounting bracket for **FD-F71**)
- **MS-FD-F7-2** (PVC mounting bracket for **FD-F71**)

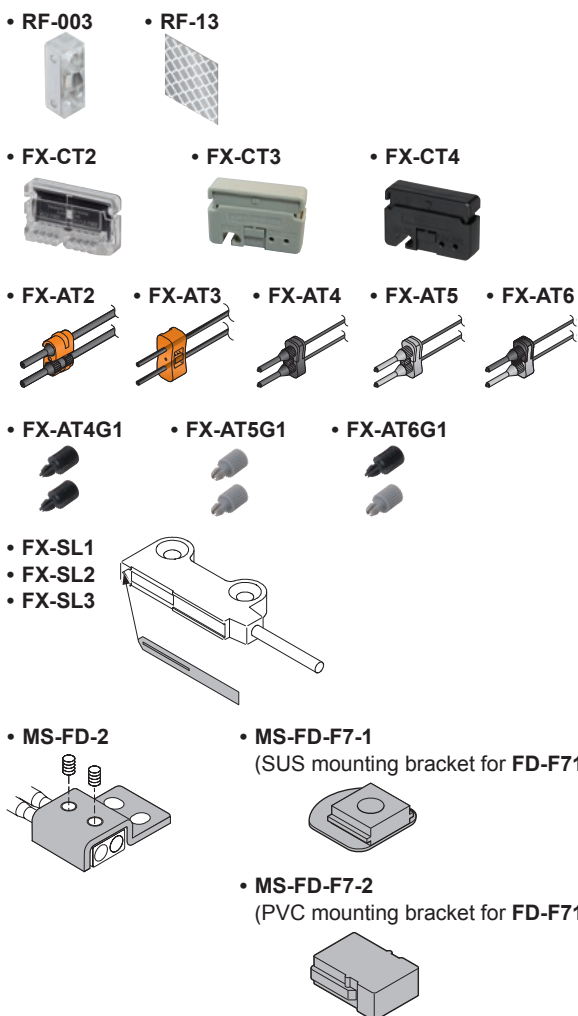

Disclaimer

The applications described in the catalog are all intended for examples only. The purchase of our products described in the catalog shall not be regarded as granting of a license to use our products in the described applications. We do NOT warrant that we have obtained some intellectual properties, such as patent rights, with respect to such applications, or that the described applications may not infringe any intellectual property rights, such as patent rights, of a third party.

Please contact

Panasonic Corporation

Industrial Device Business Division

■ 7-1-1, Morofuku, Daito-shi, Osaka 574-0044, Japan

industrial.panasonic.com/ac/e/

Panasonic[®]

©Panasonic Corporation 2021