

Amplifier Built-in
Ultra-compact Laser Sensor
EX-L200 SERIES



EX-L200 SERIES



CE

FDA
Conforming to
FDA regulations

This product is classified as a Class 1 Laser Product in IEC / JIS standards and in FDA* regulations. Do not look at the laser beam through optical system such as a lens.

*This product complies with 21 CFR 1040.10 and 1040.11 Laser Notice No. 50, dated June 24, 2007, issued by CDRH (Center for Devices and Radiological Health) under the FDA (Food and Drug Administration).

PNP output
type availableInterference
prevention

Introducing ultra-compact amplifier built-in laser sensor

Ultra-compact

Due to the customized IC and optical design, high precision detection is fulfilled with directivity and visibility achievable only by laser. The laser adopted is Class 1 (IEC / JIS / FDA) laser that is safe to use, so that there is no need to separate the areas of sensor usage.

THRU-BEAM TYPE

Minute object detection type **EX-L211**

Spread the beam and lower its density, thus even a minute object can be detected with a small change in the light received intensity. Spot size: $6 \times 4 \text{ mm}$ $0.236 \times 0.157 \text{ in}$ approx. (Visual reference value at a distance from the emitter of 1 m 3.281 ft)

Long sensing range type **EX-L212**

A long range detection of 3 m 9.843 ft is achieved. High precision detection with minimum beam spread is possible even in a long range. Spot size: $8 \times 5.5 \text{ mm}$ $0.315 \times 0.217 \text{ in}$ approx. (Visual reference value at a distance from the emitter of 1 m 3.281 ft)

REFLECTIVE TYPE

Long sensing range type **EX-L291**

Achieving ease of installation and 4 m 13.123 ft long sensing range.

Spot size: $6 \times 4 \text{ mm}$ $0.236 \times 0.157 \text{ in}$ approx. (Visual reference value at a distance from the emitter of 1 m 3.281 ft)

SPOT REFLECTIVE TYPE

Minute object detection type **EX-L221**

Highly precise sensing with minimum 0.01 mm 0.0004 in diameter. Many applications are possible due to the 300 mm 11.811 in long sensing range.

Spot size: $\varnothing 1 \text{ mm}$ $\varnothing 0.039 \text{ in}$ or less (Reference value at a distance from the emitter of 300 mm 11.811 in)

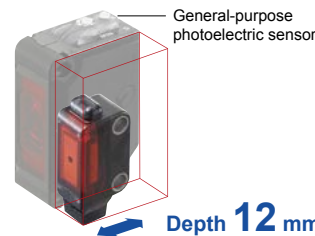
General-purpose
photoelectric sensor

Depth **12 mm 0.472 in**
W8.2 × H23.4 × D12 mm
W0.323 × H0.921 × D0.472 in
(Thru-beam type)

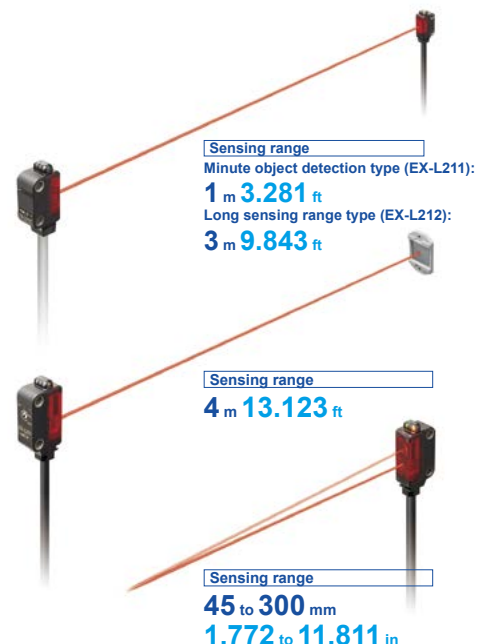

Sensing range
Minute object detection type (EX-L211):
1 m 3.281 ft
Long sensing range type (EX-L212):
3 m 9.843 ft

Sensing range
4 m 13.123 ft

Sensing range
45 to 300 mm
1.772 to 11.811 in

APPLICATIONS

Detecting ICs that are out of position in multiple palettes

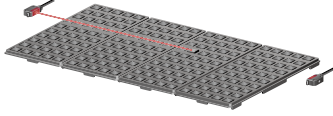

Confirming arrival of substrate

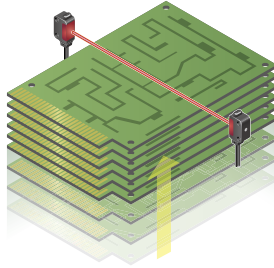

Determining cutting position of sheet

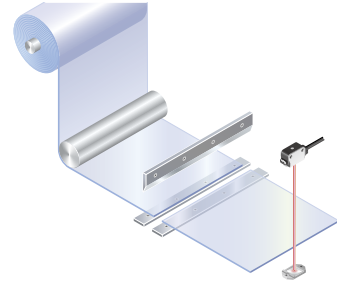

Sensing unevenly-colored workpieces

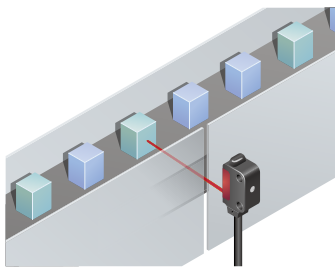

Sensing glossy or curved-surface workpiece, such as metallic pipes

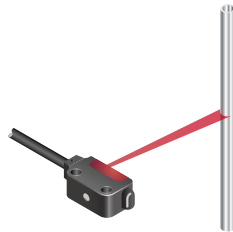

Detecting O-ring

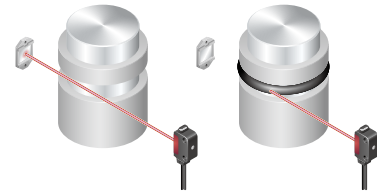
**CONVERGENT REFLECTIVE TYPE****Spot type****EX-L261**

Highly precise sensing with minimum 0.01 mm **0.0004 in** diameter. Not affected by the background, and able to reliably sense unevenly-colored workpieces.
Spot size: $\varnothing 1$ mm **$\varnothing 0.039$ in** or less (Visual reference value at a sensing distance of 50 mm **1.969 in**)

Line spot type**EX-L262**

Able to sense thin, glossy or curved-surface workpieces due to line beam.
Spot size: 5×1 mm **0.197×0.039 in** approx. (Visual reference value at a sensing distance of 50 mm **1.969 in**)

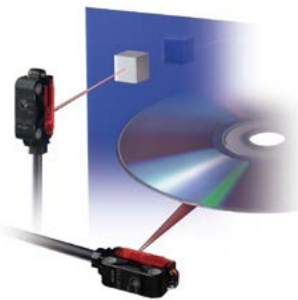
**Sensing range**

Spot type (EX-L261):

20 to 50 mm
0.787 to 1.969 in

Sensing range

Line spot type (EX-L262):

20 to 70 mm
0.787 to 2.756 in

HIGH PRECISION**Highly accurate detection** **EX-L211/L221****Suitable for positioning and minute object detection**

A repeatability of 0.02 mm **0.0008 in** or less at a range of from 100 to 200 mm **3.937 to 7.874 in** makes this type best suitable for positioning applications (typical, **EX-L221**). Moreover, it boasts a top-class detection precision in the compact laser sensor category with the gold wire of $\varnothing 0.01$ mm **$\varnothing 0.0004$ in**.

Model No. (Minute object detection type)	Minimum sensing object (Typical)	Repeatability (Typical)
EX-L211 (Thru-beam type)	$\varnothing 0.3$ mm $\varnothing 0.012$ in	0.01 mm 0.0004 in or less
EX-L221 (Spot reflective type)	$\varnothing 0.01$ mm $\varnothing 0.0004$ in	0.02 mm 0.0008 in or less

* Typical values when the sensitivity adjuster is optimally adjusted.

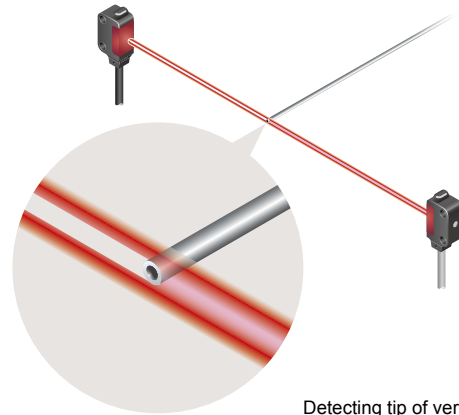

Detecting tip of very thin pipe

Dependable technology yields high precision**Incorporating a high-precision aspheric glass lens**

Light aberrations are reduced and a high definition laser spot is possible by incorporating a molded aspheric glass lens.



The secret to high precision
Molded aspheric glass lenses

Small receiver aperture for precision detection**EX-L211/L212**

Errant beams are eliminated by the $\varnothing 0.5$ mm **$\varnothing 0.020$ in** receiver aperture. Only beams entering the aperture are used, making for high-precision sensing.



The secret to high precision
 $\varnothing 0.5$ mm
 $\varnothing 0.020$ in
slit

Stable convergent distance sensing**For sensing when background object presents**

Due to convergent distance sensing, the background has very little effect, enabling stable sensing. Sensitivity adjuster allows you to adjust sensitivity to avoid sensing background objects when the distance between the workpiece and background objects is small.



Sensitivity adjuster

For sensing unevenly-colored workpieces

Able to reliably sense unevenly-colored workpieces.

EX-L261/L262**For sensing thin, glossy or curved-surface workpieces (Line spot type EX-L262)**

Able to sense glossy or curved-surface workpieces, such as PCB and metallic pipes, due to a wide line laser beam.

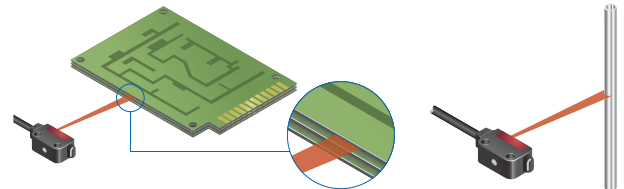

EASY ALIGNMENT**Easy beam-axis alignment****EX-L211/L212**

Visual positioning is easy due to silhouetting a sensing object against a receiver.

Visually confirm the optimal receiver position, adjusting the beam axis by aligning the objects while watching the red spot on the beam alignment screen. The diagram on the right shows an example with the lead of a mechanical pencil being detected through visual adjustment.

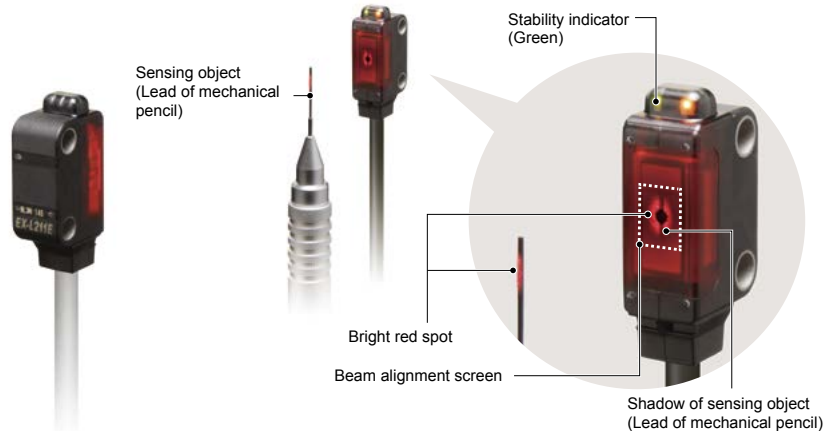
**EASY SETTING****Same mounting pitch as ultra-compact photoelectric sensor**

EX-L200 series has the same mounting pitch as ultra-compact photoelectric sensor EX-20 series so that the time taken in designing is saved.

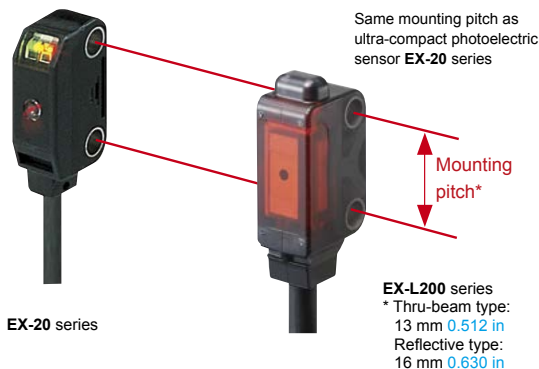
**ENVIRONMENTAL RESISTANCE****Strong against water and dust with protection structure IP67**

The sensor can be used even in environment where water or dust present because of its protection structure IP67.

**EASY TO USE****M3 screw used for secure tightening**

The mounting holes have metal sleeves inserted to prevent damage to the sensor due to over tightening of the screws. (Tightening torque: 0.5 N·m)

Conductor thickness 1.5 times increased to make wiring easier

The lead wire conductor's thickness is increased to 0.15 mm² from 0.1 mm² of the conventional ultra-compact photoelectric sensor. This makes it easier to perform crimping work on the cables for better workability. In addition, the tensile strength of the crimping area has become stronger.

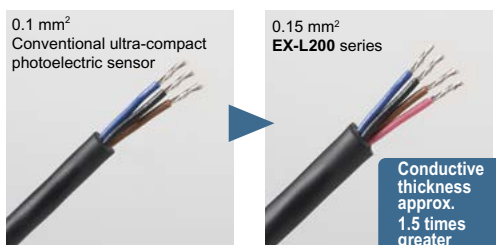
**Sensitivity adjuster (excluding EX-L212□)**

A sensitivity adjuster of small size is incorporated to offer strong performance in minute detection or high precision detection.

Low current consumption







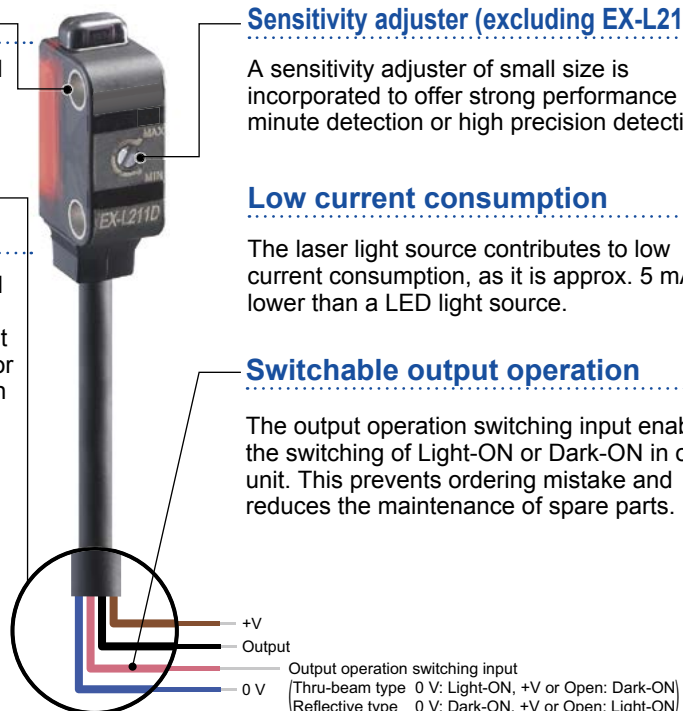



The laser light source contributes to low current consumption, as it is approx. 5 mA lower than a LED light source.

Switchable output operation

The output operation switching input enables the switching of Light-ON or Dark-ON in one unit. This prevents ordering mistake and reduces the maintenance of spare parts.

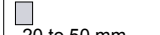

ORDER GUIDE

Type		Appearance	Sensing range	Model No.		Emission spot size (Typical)	Sensitivity adjuster
				NPN output	PNP output		
Thru-beam	Minute object detection		 1 m 3.281 ft	EX-L211	EX-L211-P	Approx. 6 × 4 mm 0.236 × 0.157 in (at a sensing distance of 1 m 3.281 ft)	Incorporated
	Long sensing range		 3 m 9.843 ft	EX-L212	EX-L212-P	Approx. 8 × 5.5 mm 0.315 × 0.217 in (at a sensing distance of 1 m 3.281 ft)	—
Retroreflective	Long sensing range		 4 m 13.123 ft (Note 2)	EX-L291	EX-L291-P	Approx. 6 × 4 mm 0.236 × 0.157 in (at a sensing distance of 1 m 3.281 ft)	Incorporated
Spot reflective	Minute object detection		 45 to 300 mm 1.772 to 11.811 in	EX-L221	EX-L221-P	ø1 mm ø0.039 in or less (at a sensing distance of 300 mm 11.811 in)	Incorporated
Convergent reflective	Spot		 20 to 50 mm 0.787 to 1.969 in (Note 5) (Convergent point: 22 mm 0.866 in)	EX-L261	EX-L261-P	ø1 mm ø0.039 in or less (at a sensing distance of 50 mm 1.969 in)	Incorporated
	Line spot		 20 to 70 mm 0.787 to 2.756 in (Note 5) (Convergent point: 22 mm 0.866 in)	EX-L262	EX-L262-P	Approx. 5 × 1 mm 0.197 × 0.039 in (at a sensing distance of 50 mm 1.969 in)	Incorporated

Notes: 1) The model No. with "E" shown on the label affixed to the thru-beam type sensor is the emitter, "D" shown on the label is the receiver.
 2) The sensing range is the value for **RF-330** reflector. The sensing range represents the actual sensing range of the sensor. The sensing ranges itemized in "A" of the table below may vary depending on the shape of sensing object. Be sure to check the operation with the actual sensing object.

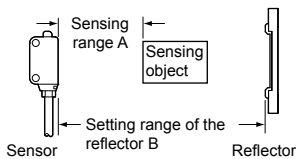

	RF-330 (Accessory)		RF-210 (Optional)	
		With PF-EXL2-1 polarizing filters (Note 3)		With PF-EXL2-1 polarizing filters (Note 3)
A	0 to 4 m 0 to 13.123 ft	0 to 4 m 0 to 13.123 ft	0 to 1.8 m 0 to 5.906 ft	0 to 1.2 m 0 to 3.937 ft
B	0.2 to 4 m 0.656 to 13.123 ft	0.4 to 4 m 1.312 to 13.123 ft (Note 4)	0.16 to 1.8 m 0.525 to 5.906 ft	0.25 to 1.2 m 0.820 to 3.937 ft (Note 4)

3) Refer to "OPTIONS (p.8)" for the polarizing filter **PF-EXL2-1** and the reflector **RF-210**.

4) When positioning the reflector nearby, the angular characteristic become more narrow. Adjust the angle of a sensor or reflector.

5) The sensing range is specified for white non-glossy paper (100 × 100 mm **3.937 × 3.937 in**) as the object.

M8 pigtailed type and 5 m 16.404 ft cable length type

M8 pigtailed type and 5 m **16.404 ft** cable length type (standard: 2 m **6.562 ft**) are also available.

When ordering these types, suffix "J" for the M8 pigtailed type, "C5" for the 5 m **16.404 ft** cable length type to the model No.

Please order the mating cable for the M8 pigtailed type separately.

(e.g.) M8 pigtailed type of **EX-L211-P** is "**EX-L211-P-J**"

5 m **16.404 ft** cable length type of **EX-L211-P** is "**EX-L211-P-C5**"

• **Mating cable** (2 cables are required for the thru-beam type.)

Type	Model No.	Cable length
Straight	CN-24A-C2	2 m 6.562 ft
	CN-24A-C5	5 m 16.404 ft
Elbow	CN-24AL-C2	2 m 6.562 ft
	CN-24AL-C5	5 m 16.404 ft

Mating cable

- **CN-24A-C2**
- **CN-24A-C5**
- **CN-24AL-C2**
- **CN-24AL-C5**

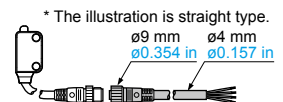

Package without reflector

Retroreflective type is also available without the reflector.

Type	Model No.	
	NPN output	PNP output
Retroreflective type	EX-L291-Y	EX-L291-P-Y
M8 pigtailed type	EX-L291-J-Y	EX-L291-P-J-Y
5 m 16.404 ft cable length type	EX-L291-C5-Y	EX-L291-P-C5-Y

Accessories

- **MS-EXL2-2** (Mounting plate for thru-beam type): 1 pc.
- **MS-EXL2-3** (Mounting plate for retroreflective/spot reflective/convergent reflective type): 1 pc.
- **RF-330** (Reflector): 1 pc.

SPECIFICATIONS

Item	Model No.	Type		Thru-beam	Retroreflective	Spot reflective	Convergent reflective		
		NPN output	PNP output	Minute object detection	Long sensing range	Long sensing range	Minute object detection	Spot	Line spot
				EX-L211	EX-L212	EX-L291	EX-L221	EX-L261	EX-L262
				EX-L211-P	EX-L212-P	EX-L291-P	EX-L221-P	EX-L261-P	EX-L262-P
CE marking directive compliance				EMC Directive, RoHS Directive					
Sensing range				1 m 3.281 ft	3 m 9.843 ft	4 m 13.123 ft (Note 2)	45 to 300 mm 1.772 to 11.811 in (Note 3)	20 to 50 mm 0.787 to 1.969 in (Convergent point: 22 mm 0.866 in) (Note 3)	20 to 70 mm 0.787 to 2.756 in (Convergent point: 22 mm 0.866 in) (Note 3)
Emission spot size (Typical)				Approx. 6 × 4 mm 0.236 × 0.157 in (vertical × horizontal) (at a sensing distance of 1 m)	Approx. 8 × 5.5 mm 0.315 × 0.217 in (vertical × horizontal) (at a sensing distance of 1 m) (Note 4)	Approx. 6 × 4 mm 0.236 × 0.157 in (vertical × horizontal) (at a sensing distance of 1 m) (Note 4)	ø1 mm ø0.039 in or less (at a sensing distance of 300 mm)	ø1 mm ø0.039 in or less (at a sensing distance of 50 mm)	Approx. 5 × 1 mm 0.197 × 0.039 in (vertical × horizontal) (at a sensing distance of 50 mm)
Sensing object				Opaque object of ø2 mm ø0.079 in or more	Opaque object of ø3 mm ø0.118 in or more	Opaque, translucent object of ø0.5 mm ø0.194 in or more	Opaque, translucent or transparent object (Note 7)		
Minimum sensing object (Typical) (Note 5)				Opaque object of ø0.3 mm ø0.012 in	—	—	Gold wire of ø0.01 mm ø0.0004 in		—
Hysteresis				20 % or less of operation distance					
Repeatability				Perpendicular to sensing axis: 0.05 mm 0.0020 in or less			Perpendicular to sensing axis: 0.2 mm 0.0080 in or less		
Repeatability (Typical) (perpendicular to sensing axis) (Note 5)				0.01 mm 0.0004 in or less (all area)			0.02 mm 0.0008 in or less (at 100 to 200 mm sensing distance)		
Supply voltage				12 to 24 V DC ±10 % Ripple P-P 10 % or less					
Current consumption				Emitter: 10 mA or less, Receiver: 10 mA or less			15 mA or less		
Output				<NPN output type> NPN open-collector transistor • Maximum sink current: 50 mA • Applied voltage: 26.4 V DC or less (between output and 0 V) • Residual voltage: 2 V or less (at 50 mA sink current) 1 V or less (at 16 mA sink current)			<PNP output type> PNP open-collector transistor • Maximum source current: 50 mA • Applied voltage: 26.4 V DC or less (between output and +V) • Residual voltage: 2 V or less (at 50 mA source current) 1 V or less (at 16 mA source current)		
Output operation				Light-ON / Dark-ON selectable by the output operation switching input					
Short-circuit protection				Incorporated (short-circuit protection / inverse polarity protection)					
Response time				0.5 ms or less					
Operation indicator				Orange LED (lights up when the output is ON) (incorporated on the receiver for thru-beam type)					
Stability indicator				Green LED (lights up under stable light received condition or stable dark condition) (incorporated on the receiver for thru-beam type)					
Power indicator				Green LED (lights up when the power is ON) (incorporated on the emitter)			—		
Automatic interference prevention function				—			Incorporated (Two sensors can be mounted close together.)		
Sensitivity adjuster				Continuously variable adjuster (receiver)			Continuously variable adjuster		
Environmental resistance	Protection				IP67 (IEC)				
	Ambient temperature				-10 to +55 °C +14 to +131 °F (No dew condensation or icing allowed), Storage: -30 to +70 °C -22 to +158 °F				
	Ambient humidity				35 to 85 % RH, Storage: 35 to 85 % RH				
	Ambient illuminance				Incandescent light: 3,000 lx or less at the light-receiving face				
	Voltage withstandability				1,000 V AC for one min. between all supply terminals connected together and enclosure				
	Insulation resistance				20 MΩ, or more, with 250 V DC megger between all supply terminals connected together and enclosure				
	Vibration resistance				10 to 500 Hz frequency, 1.5 mm 0.059 in double amplitude (10 G max.) in X, Y and Z directions for two hours each				
	Shock resistance				500 m/s ² acceleration (50 G approx.) in X, Y and Z directions three times each				
Emitting element				Red semiconductor laser Class 1 [IEC / JIS / FDA (Note 6)] (Maximum output: EX-L211 □ / EX-L212 □: 390 μW, EX-L291 □: 0.5 mW, EX-L221 □: 2 mW, EX-L261 □: 1 mW, EX-L262 □: 1.3 mW, Peak emission wavelength: 655 nm 0.026 mil)					
Material				Enclosure: Polybutylene terephthalate, Front cover: Acrylic, Lens: Glass, Indicator part: Polyarylate					
Cable				0.15 mm ² 4-core (emitter of a thru-beam type: 2-core) cable, 2 m 6.562 ft long					
Cable extension				Extension up to total 50 m 164.042 ft is possible with 0.3 mm ² , or more, cable (thru-beam type: Total 100 m 328.084 ft both emitter and receiver).					
Weight				Net weight: Emitter 40 g approx., Receiver 40 g approx., Gross weight: 90 g approx.			Net weight: 45 g approx., Gross weight: 60 g approx.		
Accessories				MS-EXL2-2 (Mounting plate): 2 pcs.		RF-330 (Reflector): 1 pc. MS-EXL2-3 (Metal plate): 1 pc.	MS-EXL2-3 (Mounting plate): 1 pc.		

Notes: 1) Where measurement conditions have not been specified precisely, the conditions used were an ambient temperature of +23 °C **+73.4 °F**.

2) The sensing range is the value for **RF-330** reflector. The sensing range represents the actual sensing range of the sensor. The sensing ranges itemized in "A" of the table below may vary depending on the shape of sensing object. Be sure to check the operation with the actual sensing object.

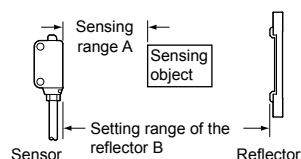

	RF-330 (Accessory)		RF-210 (Optional)	
	With PF-EXL2-1 polarizing filters *1	Without	With PF-EXL2-1 polarizing filters *1	Without
A	0 to 4 m 0 to 13.123 ft	0 to 4 m 0 to 13.123 ft	0 to 1.8 m 0 to 5.906 ft	0 to 1.2 m 0 to 3.937 ft
B	0.2 to 4 m 0.656 to 13.123 ft	0.4 to 4 m 1.312 to 13.123 ft *2	0.16 to 1.8 m 0.525 to 5.906 ft	0.25 to 1.2 m 0.820 to 3.937 ft *2

*1 Refer to "OPTIONS" (P.8) for the polarizing filter **PF-EXL2-1** and the reflector **RF-210**.

*2 When positioning the reflector nearby, the angular characteristic become more narrow. Adjust the angle of a sensor or

3) The sensing range is specified for white non-glossy paper (100 × 100 mm **3.937 × 3.937 in**) as the object.

4) **EX-L212** □: In the case sensing distance is 3 m **9.843 ft**, the emission spot size is H 17 × W 11 mm **H 0.669 × W 0.433 in** (visual reference value).

EX-L291 □: In the case sensing distance is 4 m **13.123 ft**, the emission spot size is H 18 × W 10 mm **H 0.709 × W 0.394 in** (visual reference value).

5) Typical values when the sensitivity adjuster is optimally adjusted.

6) This product complies with 21 CFR 1040.10 and 1040.11 Laser Notice No. 50, dated June 24, 2007, issued by CDRH

(Center for Devices and Radiological Health) under the FDA (Food and Drug Administration).

7) Make sure to confirm detection with an actual sensor before use.

OPTIONS

Designation	Model No.	Description
Sensor mounting bracket	MS-EXL2-1	Foot angled mounting bracket (The thru-beam type sensor needs two brackets.)
	MS-EXL2-5	Back angled mounting bracket (The thru-beam type sensor needs two brackets.)
	MS-EXL2-6	Compatible bracket for thru-beam type A bracket to easily mount EX-L21 on the 25.4 mm 1.000 in pitch sensor mounting bracket: Use with the mounting plate attached to the sensor. Two brackets are needed when used for the emitter and the receiver.
Universal sensor mounting bracket	MS-EXL2-4	It can adjust the height and the angle of the sensor. (The thru-beam type sensor needs two brackets.)
Polarizing filter	PF-EXL2-1	For retroreflective type EX-L291 Stabilizes sensitivity of the reflective surface.
Reflector	RF-210	For retroreflective type EX-L291 Sensing range: 1.8 m 5.906 in (Note)
Reflector mounting bracket	MS-RF21-1	Protective mounting bracket for RF-210 It protects the reflector from damage and maintains alignment.

Note: Set the distance between the reflector and sensor to be at least 0.16 m 0.525 ft. Refer to "ORDER GUIDE (p.6)" for details.

Sensor mounting bracket

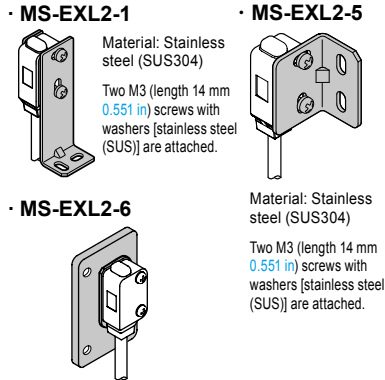

Reflector

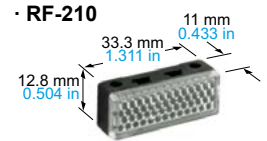

Reflector mounting bracket

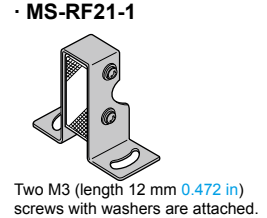

Material: Stainless steel (SUS304)
Two M3 (length 12 mm 0.472 in) screws with washers [stainless steel (SUS)] are attached.

Material: Stainless steel (SUS304)
Two M3 (length 14 mm 0.551 in) screws with washers [stainless steel (SUS)] are attached.

Polarizing filter

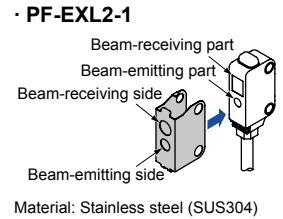

Universal sensor mounting bracket

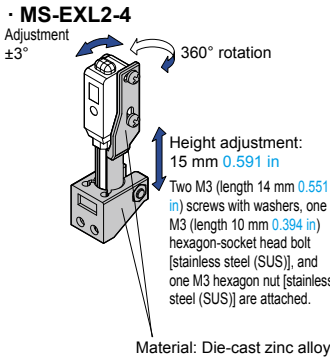

I/O CIRCUIT DIAGRAMS

NPN output type

I/O circuit diagram

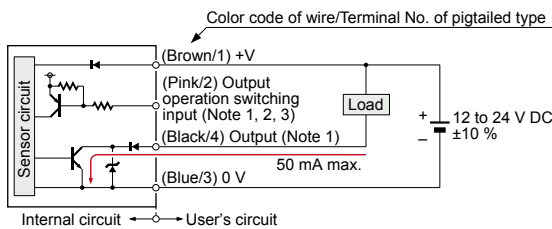

- Notes: 1) The emitter of a thru-beam type does not incorporate output (black/4) and output operation switching input (pink/2).
2) Be able to select either Light-ON or Dark-ON by wiring the output operation switching input (pink/2) as shown in the following table.

Type	Light-ON	Dark-ON
Thru-beam, Retroreflective	Connect to 0 V	Connect to +V or, Open
Spot reflective/ Convergent reflective	Connect to +V or, Open	Connect to 0 V

* Insulate the output operation switching input wire (pink/2) when leaving it open.

- 3) When connecting the mating cable to the pigtailed type, color code of wire is "white".

Connector pin position (pigtailed type)

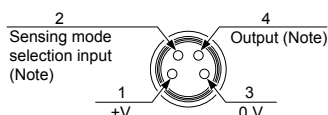

Note: The emitter of a thru-beam type does not incorporate output and output operation switching input.

PNP output type

I/O circuit diagram

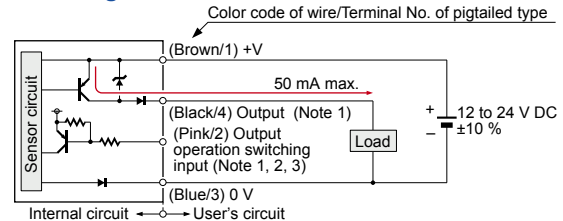

- Notes: 1) The emitter of a thru-beam type does not incorporate output (black/4) and output operation switching input (pink/2).
2) Be able to select either Light-ON or Dark-ON by wiring the output operation switching input (pink/2) as shown in the following table.

Type	Light-ON	Dark-ON
Thru-beam, Retroreflective	Connect to 0 V	Connect to +V or, Open
Spot reflective/ Convergent reflective	Connect to +V or, Open	Connect to 0 V

* Insulate the output operation switching input wire (pink/2) when leaving it open.

- 3) When connecting the mating cable to the pigtailed type, color code of wire is "white".

Connector pin position (pigtailed type)

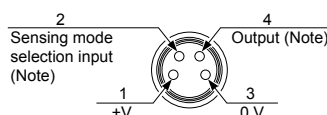

Note: The emitter of a thru-beam type does not incorporate output and output operation switching input.

SENSING CHARACTERISTICS (TYPICAL)

EX-L211 □ Thru-beam type

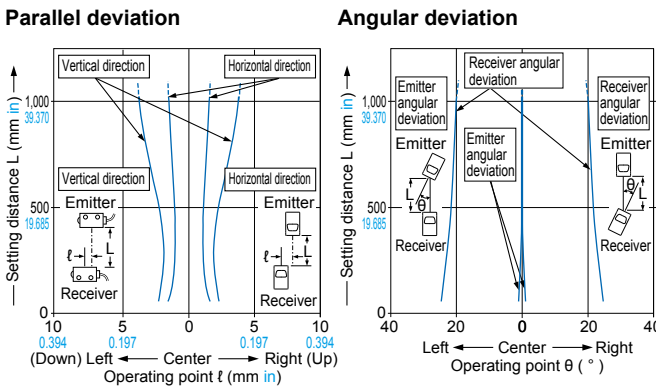

EX-L212 □ Thru-beam type

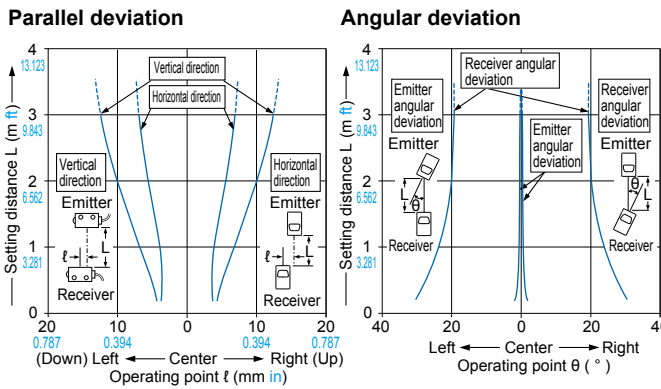

EX-L291 □ Retroreflective type

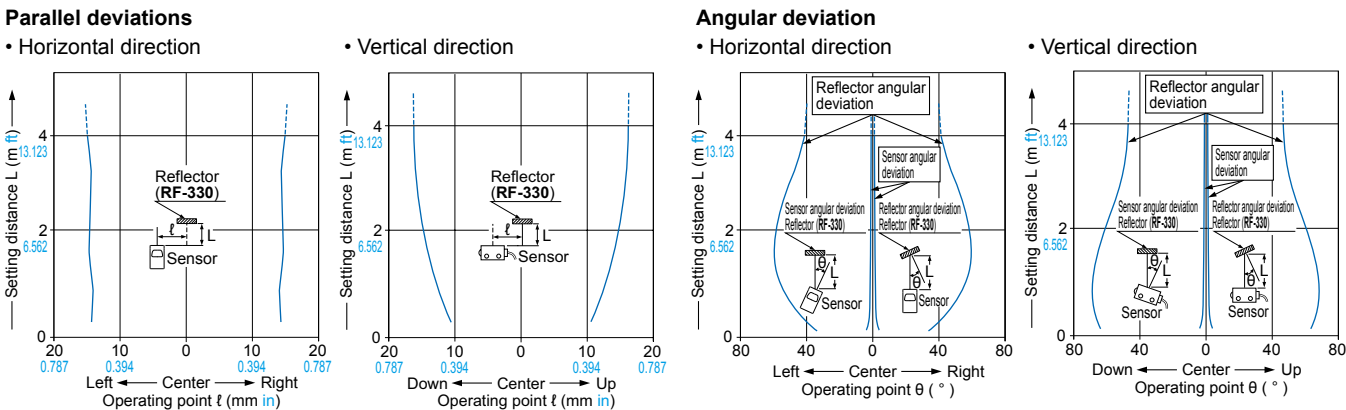

EX-L221 □ Spot reflective type

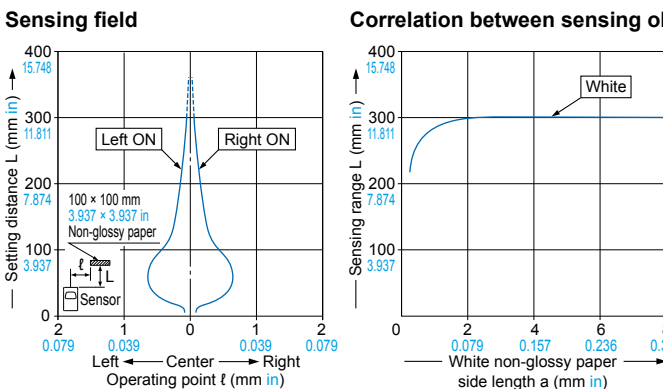

As the sensing object size becomes smaller than the standard size (white non-glossy paper 100 × 100 mm 3.937 × 3.937 in), the sensing range shortens, as shown in the left graph.
 (For plotting the left graph, the sensitivity has been set such that a 100 × 100 mm 3.937 × 3.937 in white non-glossy paper is just detectable at a distance of 300 mm 11.811 in.)

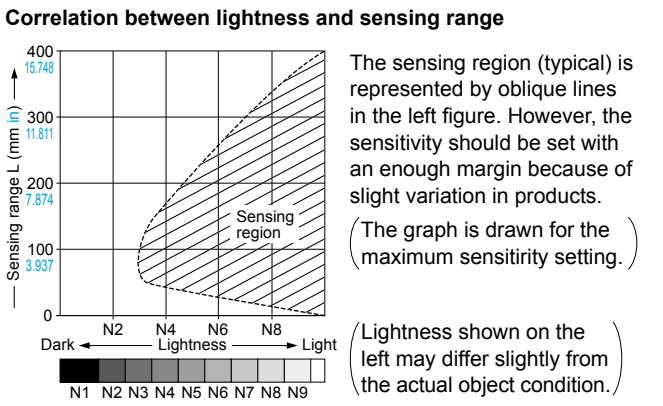

The sensing region (typical) is represented by oblique lines in the left figure. However, the sensitivity should be set with an enough margin because of slight variation in products.
 (The graph is drawn for the maximum sensitivity setting.)
 (Lightness shown on the left may differ slightly from the actual object condition.)

SENSING CHARACTERISTICS (TYPICAL)

EX-L261

Convergent reflective type

Sensing fields

- Horizontal (left and right) direction
- Vertical (up and down) direction

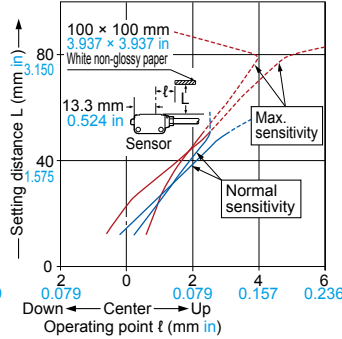
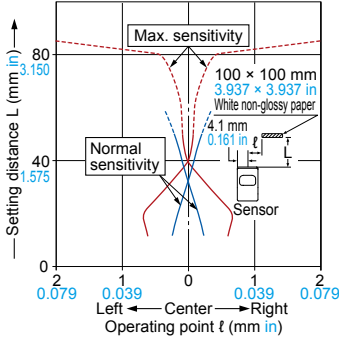

Emitted beam

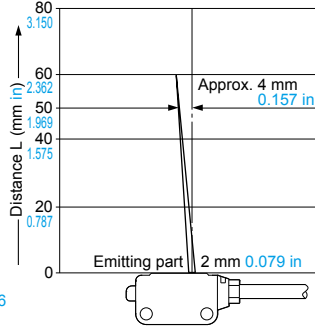

Correlation between lightness and sensing range

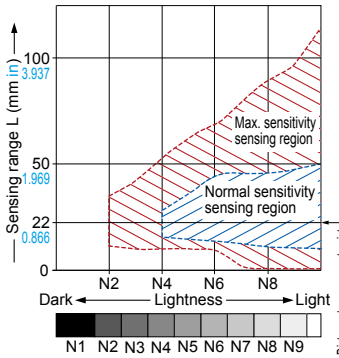

The sensing region (typical) is represented by oblique lines in the left figure. However, the sensitivity should be set with enough margin because of slight variation in products.

(Lightness shown on the left may differ slightly from the actual object condition.)

Correlation between material and sensing range (face-to-face)

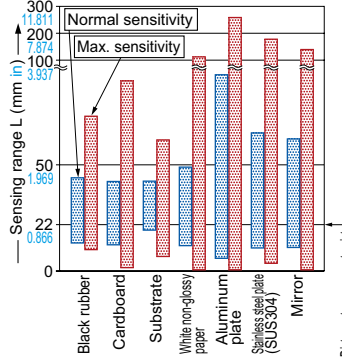

The bars in the graph indicate the sensing range (typical) for the respective material. However, there is a slight variation in the sensing range depending on the product. Further, if there is a reflective object (conveyor, etc.) in the background of the sensing object, since it affects the sensing, separate it by more than twice the sensing range shown in the left graph, or adjust the sensitivity adjuster. Make sure to confirm detection with an actual sensor.

EX-L262

Convergent reflective type

Sensing fields

- Horizontal (left and right) direction
- Vertical (up and down) direction

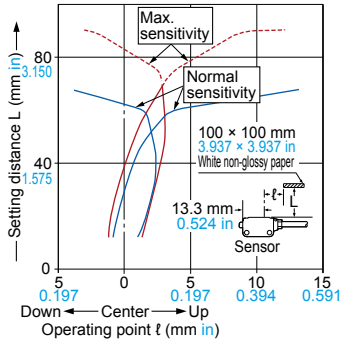
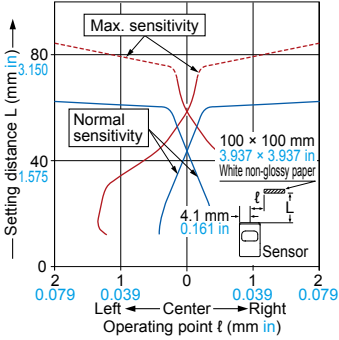

Emitted beam

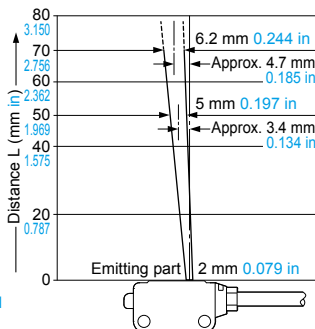

Correlation between lightness and sensing range

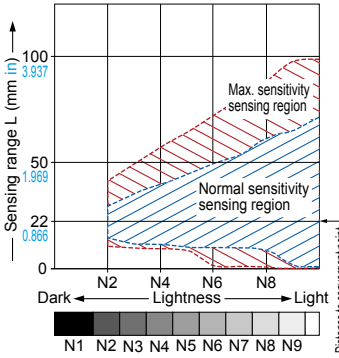

The sensing region (typical) is represented by oblique lines in the left figure. However, the sensitivity should be set with enough margin because of slight variation in products.

(Lightness shown on the left may differ slightly from the actual object condition.)

Correlation between material and sensing range (face-to-face)

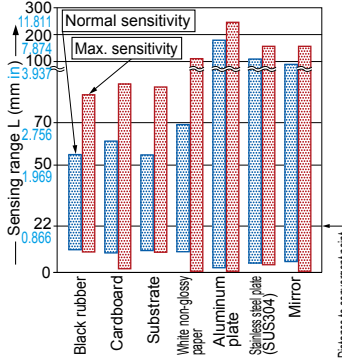

The bars in the graph indicate the sensing range (typical) for the respective material. However, there is a slight variation in the sensing range depending on the product. Further, if there is a reflective object (conveyor, etc.) in the background of the sensing object, since it affects the sensing, separate it by more than twice the sensing range shown in the left graph, or adjust the sensitivity adjuster. Make sure to confirm detection with an actual sensor.

PRECAUTIONS FOR PROPER USE

- This catalog is a guide to select a suitable product. Be sure to read the instruction manual attached to the product prior to its use.



- Never use this product as a sensing device for personnel protection.
- In case of using sensing devices for personnel protection, use products which meet laws and standards, such as OSHA, ANSI or IEC etc., for personnel protection applicable in each region or country.

Cautions for laser beams



- This product is classified as a Class 1 Laser Product in IEC / JIS standards and in FDA* regulations. Do not look at the laser beam through optical system such as a lens.
- The following label is attached to the cable. Handle the product according to the instruction given on the warning label.

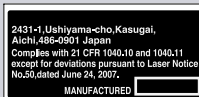

Proof label

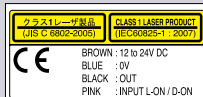

Warning label

*This product complies with 21 CFR 1040.10 and 1040.11 Laser Notice No. 50, dated June 24, 2007, issued by CDRH (Center for Devices and Radiological Health) under the FDA (Food and Drug Administration).

Safety standards for laser beam products

- A laser beam can harm human being's eyes, skin, etc., because of its high energy density. IEC has classified laser products according to the degree of hazard and the stipulated safety requirements. **EX-L200** series is classified as Class 1 laser.

Classification by IEC 60825-1

Classification	Description
Class 1	Lasers that are safe under reasonably foreseeable conditions of operation, including the use of optical instruments for intrabeam viewing.

Safe use of laser products

- For the purpose of preventing users from suffering injuries by laser products, IEC 60825-1 (Safety of laser products). Kindly check the standards before use.

Mounting

- When mounting this sensor, use a mounting plate (**MS-EXL2-2**, **MS-EXL2-3**). Without using the mounting plate, beam misalignment may occur. Also, install the mounting plate in between the sensor and the mounting surface.
- The tightening torque should be 0.5 N·m or less.

Note: The mounting direction of the mounting plate is fixed. Install in a way so that the bending shape is facing the sensor side.

EX-L21□

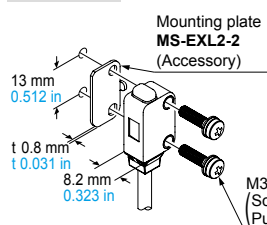

EX-L291□/L221□/L261□/262□

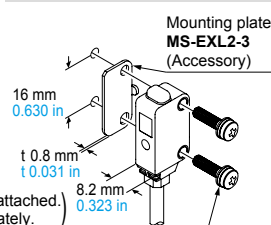

Automatic interference prevention function

- Spot reflective type sensor incorporate this function. Up to two sets of sensor can be mounted closely. (Thru-beam type sensor does not have this function.)

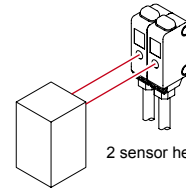

2 sensor heads can be mounted adjacently.

Note: If two spot reflective type sensor are mounted facing each other, they should be angled so as not to receive the beam from the opposing sensor or to detect its front face.

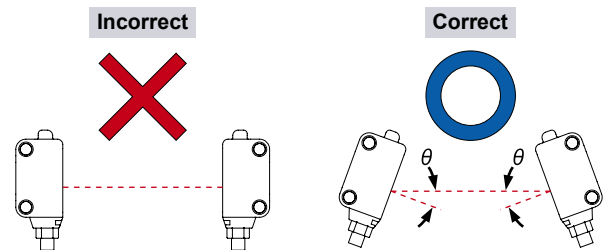

Others

- Do not use during the initial transient time (approx. 50ms) after the power supply is switched ON.
- In case the load and this sensor are connected to different power supplies, be sure to turn ON the power from the sensor.
- The cable may break by applying excess stress in low temperature.
- Do not allow any water, oil fingerprints, etc., which may refract light, or dust, dirt, etc., which may block light, to stick to the emitting/receiving surfaces of the sensor head. In case they are present, wipe them with a clean, soft cloth or lens paper. Do not use this sensor in places having excessive vapor, dust, etc., or where it may come in contact with corrosive gas.
- Take care that the sensor does not come in direct contact with oil, grease, organic solvents, such as, thinner etc., or strong acid, and alkaline.
- Make sure that the power is OFF while cleaning the emitting/receiving windows of the sensor head.
- This device is using a laser which has high directional quality. Therefore the beam possibly be out of alignment by the mounting condition of this device or distortion of housing etc. Make sure to adjust the beam axe alignment before use.

DIMENSIONS (Unit: mm in)

The CAD data can be downloaded from our website.

EX-L211(-P) EX-L212(-P) Sensor

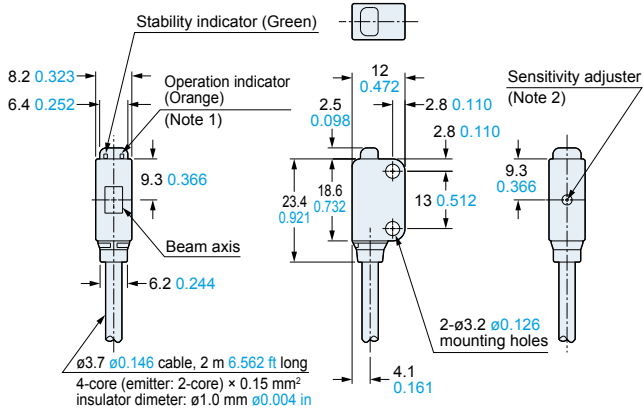

Notes: 1) It is the laser radiation indicator (green) on the emitter.
2) It is incorporated in EX-L211(-P) only.

EX-L211(-P)-J EX-L212(-P)-J Sensor

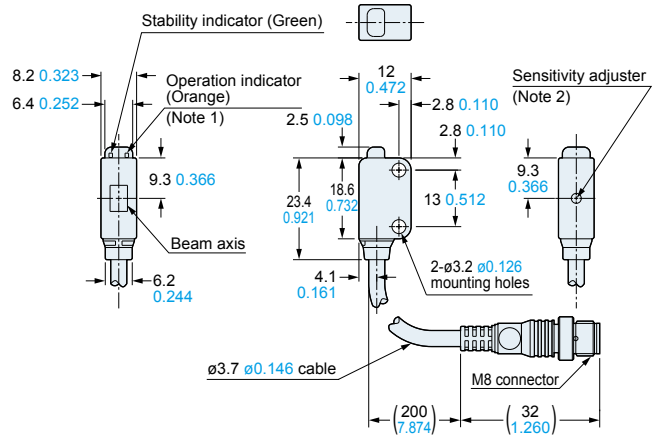

Notes: 1) It is the laser radiation indicator (green) on the emitter.
2) It is incorporated in EX-L211(-P)-J only.

EX-L291(-P) EX-L221(-P) Sensor

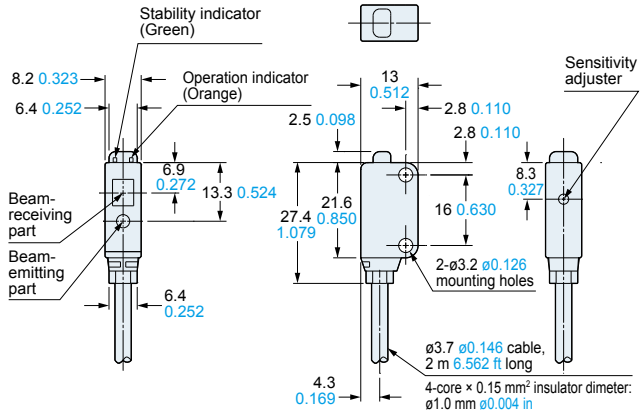

EX-L291(-P)-J EX-L221(-P) Sensor

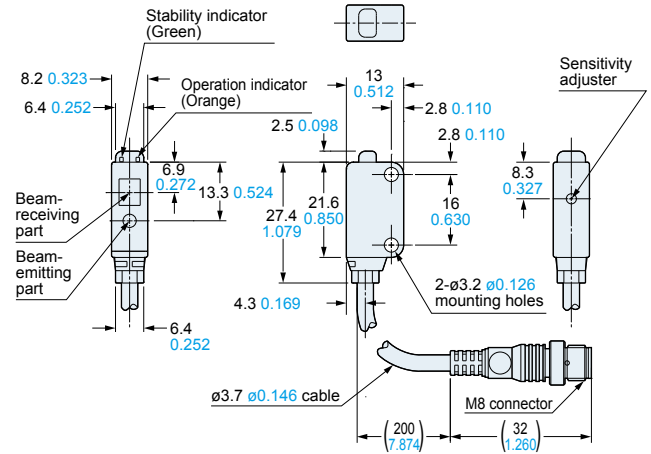

Assembly dimensions with polarizing filter (PF-EXL2-1)

Mounting drawing with EX-L291(-P)

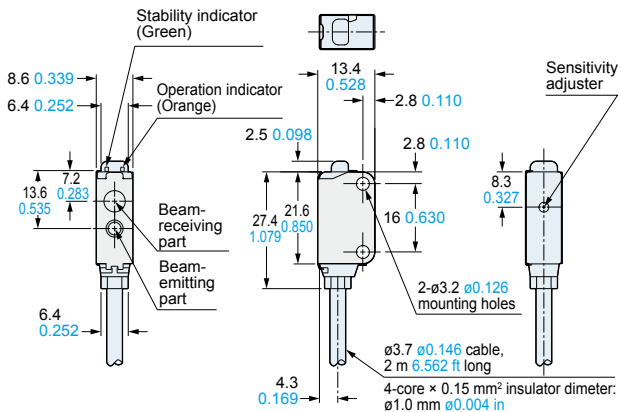

EX-L261(-P) EX-L262(-P) Sensor

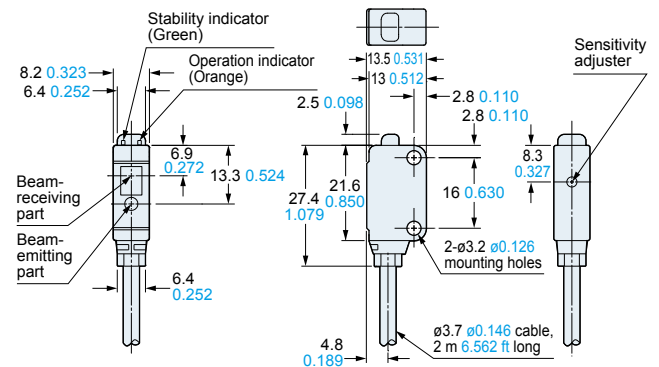

DIMENSIONS (Unit: mm in)

The CAD data can be downloaded from our website.

RF-330 Reflector (Accessory for EX-L291□)

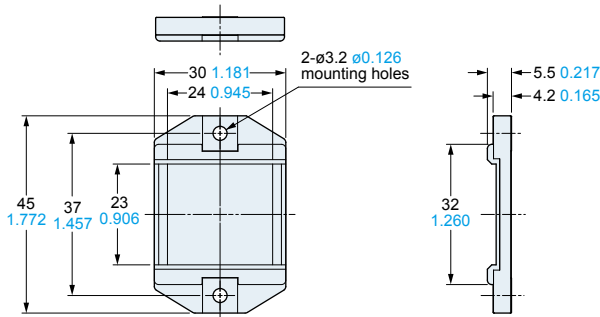

Material: Acrylic (Reflector)
ABS (Base)

RF-210 Reflector (Optional)

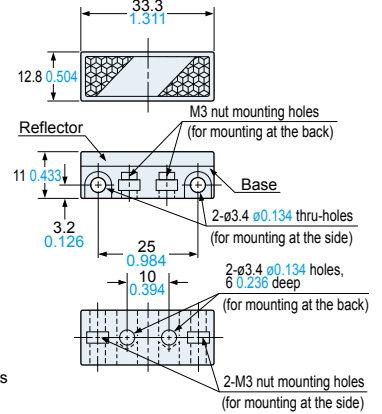

Material: Acrylic (Reflector)
ABS (Base)
Two M3 (length 8 mm 0.315 in) screws with washers and two nuts are attached.

MS-RF21-1 Reflector mounting bracket for RF-210 (Optional)

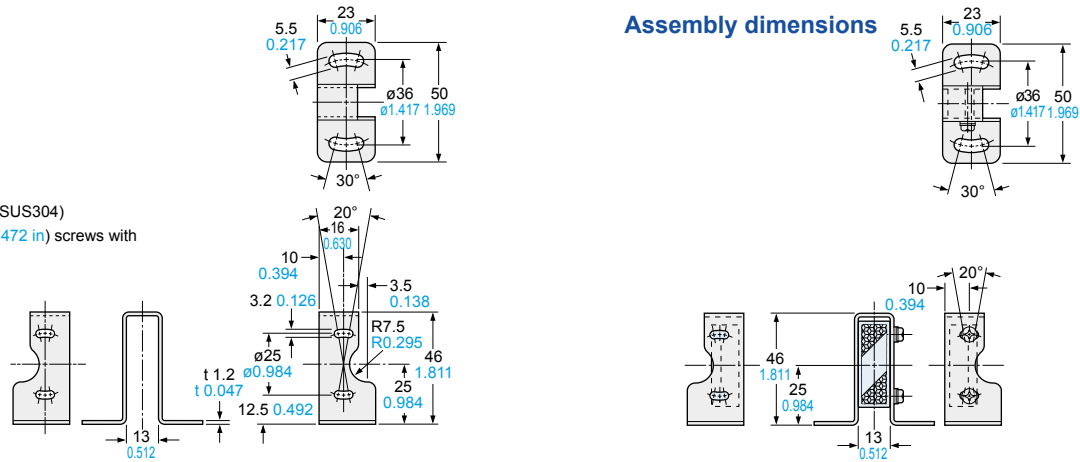

Material: Stainless steel (SUS304)
Two M3 (length 12 mm 0.472 in) screws with washers are attached.

MS-EXL2-1 Sensor mounting bracket (Optional)

Foot angled mounting bracket

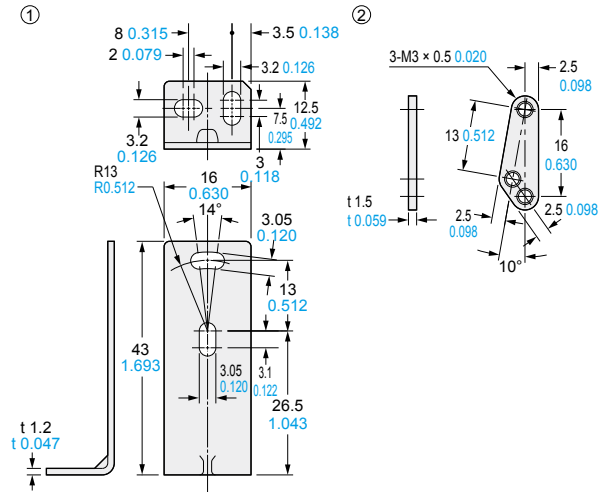

Material: Stainless steel (SUS304)
Two M3 (length 14 mm 0.551 in) screws with washers [stainless steel (SUS)] are attached.

Assembly dimensions

Mounting drawing with the receiver of EX-L211□/L212□

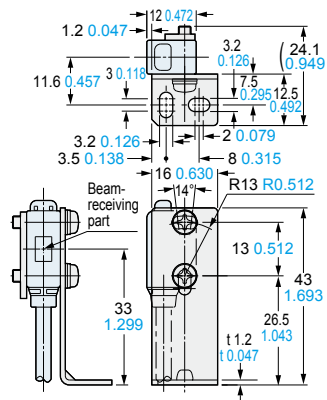

Mounting drawing with the receiver of EX-L291□/L221□/L261□/L262□

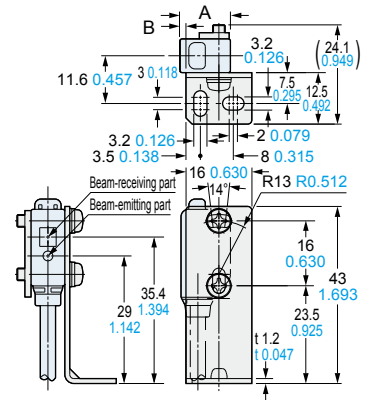

Model No.	A	B
EX-L291□ / L221□	13 0.512	2.2 0.087
EX-L261□ / L262□	13.5 0.532	2.7 0.106

DIMENSIONS (Unit: mm in)

The CAD data can be downloaded from our website.

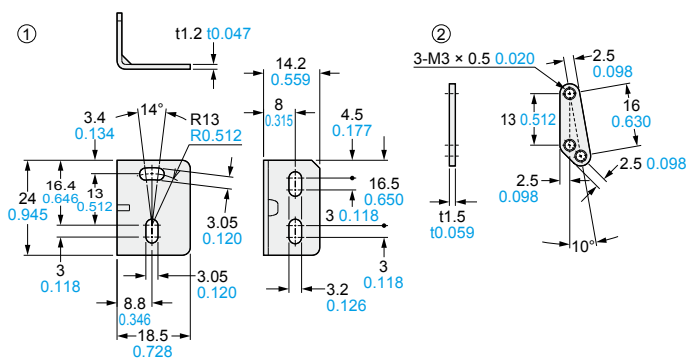
MS-EXL2-5 Sensor mounting bracket (Optional)**Back angled mounting bracket**

Material: Stainless steel (SUS304)

Two M3 (length 14 mm 0.551 in) screws with washers [stainless steel (SUS)] are attached.

Disclaimer

The applications described in the catalog are all intended for examples only. The purchase of our products described in the catalog shall not be regarded as granting of a license to use our products in the described applications. We do NOT warrant that we have obtained some intellectual properties, such as patent rights, with respect to such applications, or that the described applications may not infringe any intellectual property rights, such as patent rights, of a third party.

Panasonic
INDUSTRY

Panasonic Industry Co., Ltd.

Industrial Device Business Division

7-1-1, Morofuku, Daito-shi, Osaka 574-0044, Japan

industrial.panasonic.com/ac/e/