



Programmable Logic Controller

# XGT Series



**LSIS**

XGT series, innovative solutions for system integration  
from field to information level.  
Open Network System Integration



neXt Generation Technology  
**XGT** Series



**FEATURES** 4 ~ 13

FEATURES



**CPU** 14 ~ 31

CPU



**SYSTEM** 32 ~ 47

SYSTEM



**NETWORK** 48 ~ 85

NETWORK



**SPECIAL** 86 ~ 119

SPECIAL



**SOFTWARE** 120 ~ 141

SOFTWARE

## Welcome to XGT World!

XGT series will meet your needs and expectations, enabling the highest possible productivity and performance levels and more.



**XGK** / CPUU CPUS  
CPUH CPUE  
CPUA



XGR



XGK / CPUUN  
CPUHN  
CPUSN



## Features

XGT series is the next-generation solution with a new concept providing advanced engineering environment based on open network, fastest processing speed, compact size and user-friendly software.



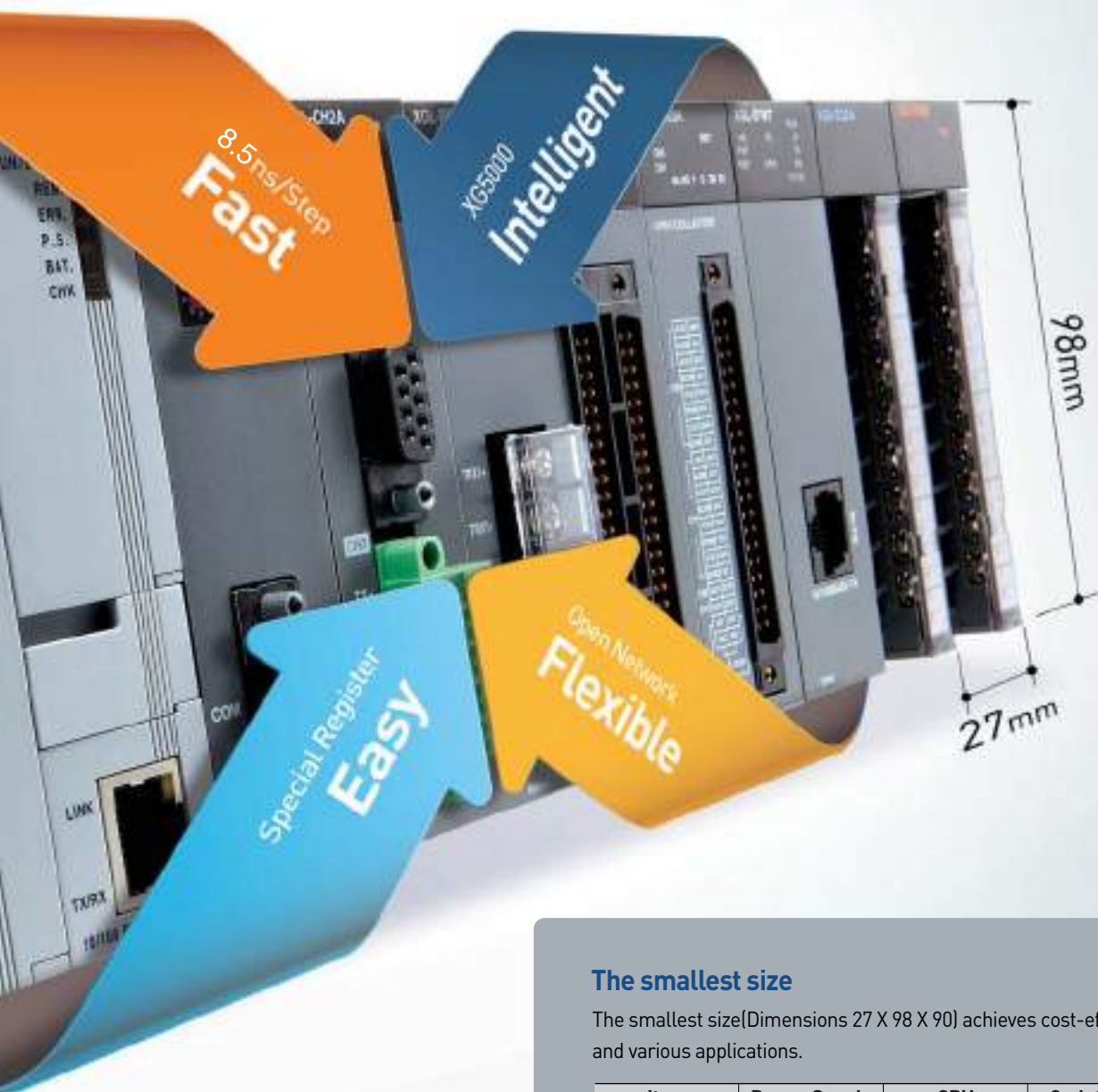

### The smallest size

The smallest size(Dimensions 27 X 98 X 90) achieves cost-efficiency and various applications.

Item	Power Supply	CPU	8-slot Base
Size (WXHXD)	55X98X90	27X98X90	318X98X17

## Features

XGT series, neXt Generation Technology for easier, faster and smarter automation, will provide you with future-oriented solutions, bringing greener, safer and more convenient life for you...

### System Integration of Open Network

XGT series support various communication solutions ranging from field control to information level with Fast Ethernet, Profibus-DP, DeviceNet, Modbus, etc.





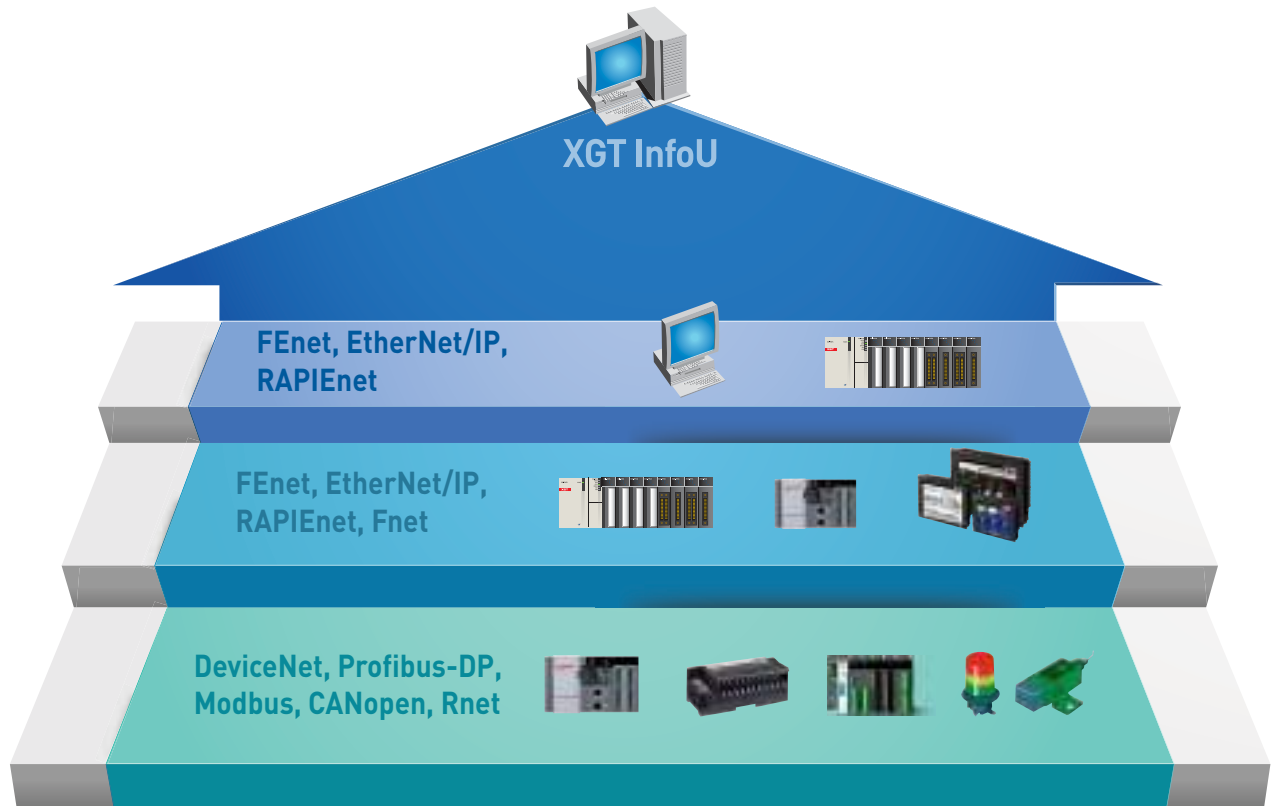

Item	Fast Ethernet		RAPIEnet	EtherNet/IP	Cnet	Fnet	Profibus-DP	DeviceNet	Rnet
	FEnet	FEEnet							
Transmission speed	10/100Mbps		100Mbps	100Mbps	300-115,200bps	1Mbps	Max.12Mbps	Max.500Kbps	1Mbps
Transmission distance	100m (Node to Node, UTP/STP) 2km (Node to Node, Fiber Optic)			100m(TP)	Max. 500m (422/485)	750m(Seg) Max. 5.25km	Max. 12km	Max. 500m	750m(Seg) Max. 5.25km
Max. number of station	64 (HS link)		64	TCP64/128 (Client/Server) CIO 64/128 (Client/Server)	32	64	32(Seg) 126	64	64
	16(Server)	-							
Service	HS link	●	●	-	-	●	●	●	●
	XG protocol	●	-	-	●	-	-	-	-
	General protocol	● Modbus TCP/IP	-	-	● EtherNet/IP	● Modbus RTU/ASCII	-	-	-
	P2P	●	●	●	●	●	-	-	-
	XG5000 I/F	●	●	●	●	●	-	-	-
	E-Mail	●	-	-	-	-	-	-	-
Configuration software	XG5000						XG5000 & Proficon		XG5000
Number of installation	24 (HS link Service : 12, P2P Service : 8)								



Do you want more powerful features and performance? answer is LSIS

### XGT New CPU

New XGT CPU has 3 times faster cpu processing speed, 2 times larger memory capacity and built in ethernet port.

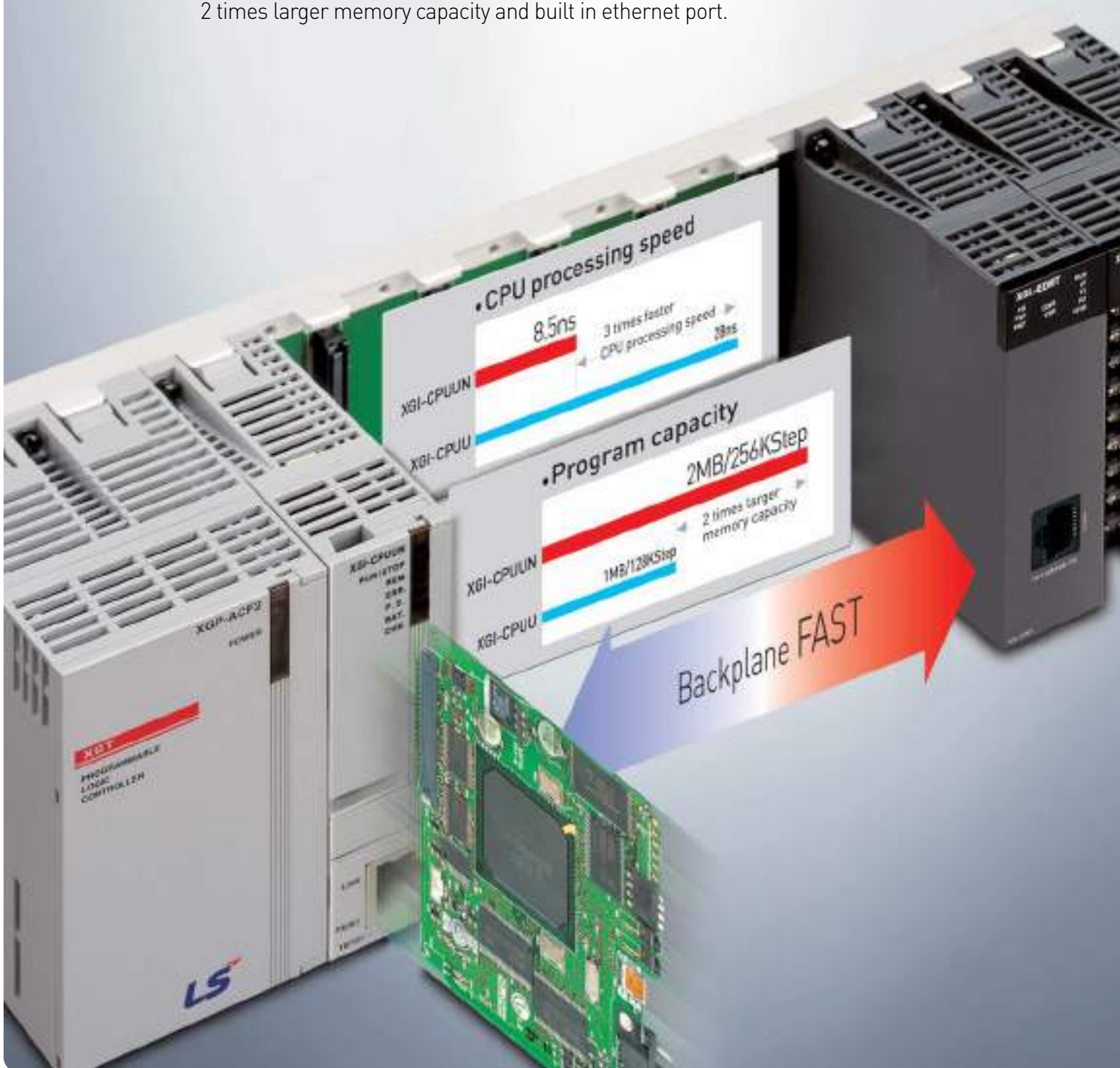

### Compare of scan time between XGI-CPUU and XGI-CPUUN

#### Using 1 MOVE word

Item	XGI-CPUUN	XGI-CPUU/D	XGI-CPUU	XGI-CPUH	XGI-CPUS
Current scan time	0.2ms	0.6ms	0.9ms	1.0ms	0.8ms
Min. scan time	0.2ms	0.6ms	0.8ms	1.0ms	0.7ms
Max. scan time	0.4ms	0.9ms	1.5ms	1.8ms	1.7ms

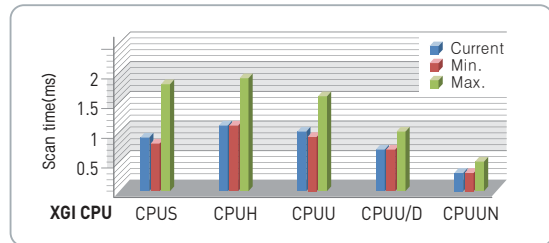

#### Using 1,000 MOVE word

Item	XGI-CPUUN	XGI-CPUU/D	XGI-CPUU	XGI-CPUH	XGI-CPUS
Current scan time	0.5ms	1.2ms	1.7ms	1.7ms	1.5ms
Min. scan time	0.5ms	1.2ms	1.6ms	1.6ms	1.5ms
Max. scan time	0.7ms	1.5ms	2.3ms	2.5ms	2.3ms

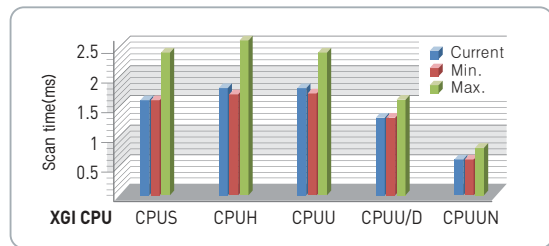

### Device memory range

CPU	Device memory	XGI-CPUU	XGI-CPUUN
XGI CPU	A	512KB	1024KB
	M	256KB	512KB
XGK CPU	P/M/K	32,768 point	65,536 point
	T	T000 - T2047	T000 - T8191
	C/S/Z, R/ZR	2 ~ 8 times larger	

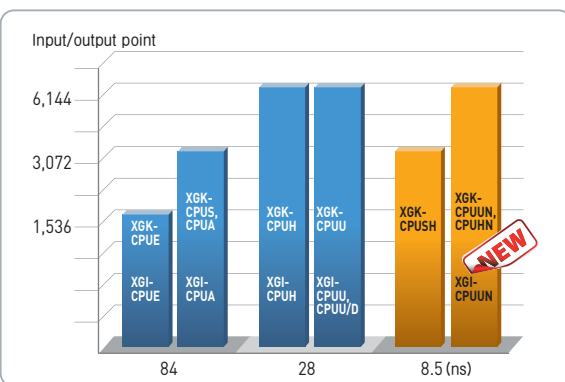

### Easy connection

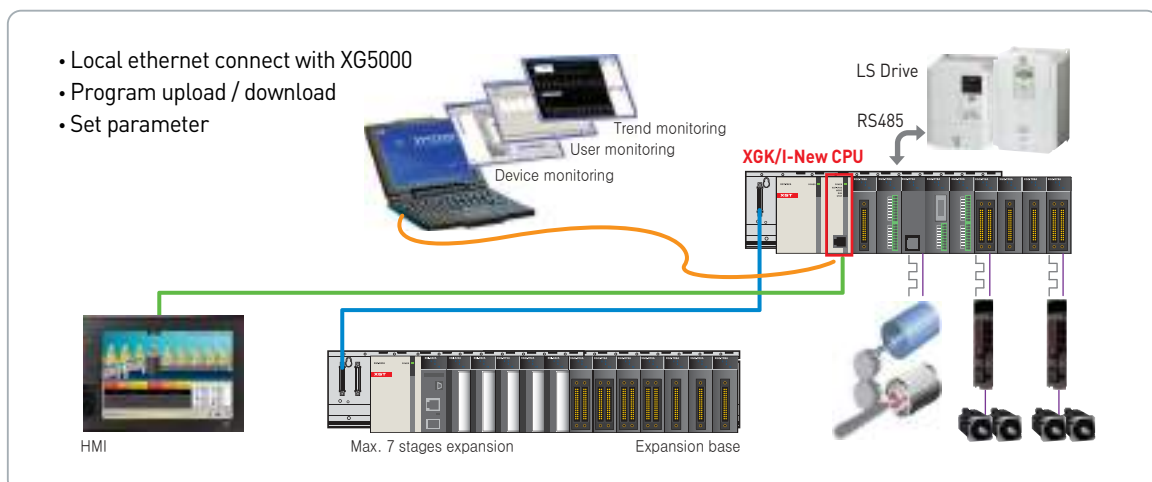

# Engineering & Programming Innovation Easy

## Special Register

XGT series expand device memory and support advanced programming environment with Index register (Z), File register (U), and Analog register (U).



### File register

As a non-volatile memory type, data are secured even in times of blackout or CPU reset.



### Analog register

Assigning base, slot and memory buffer of an analog module to device, A/D conversion data can be accessed without analog commands.



### Index register

Index register is used in the sequence program for array operation.

### Example of Analog Register

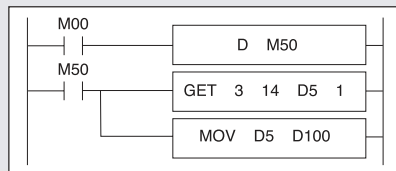

KGLWIN

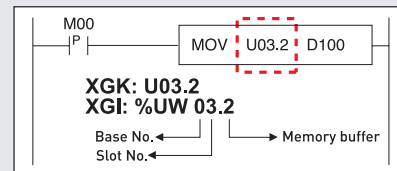

XG5000

## Analog Operation without Programming

Special module setup and operation is achieved by just parameter setting without additional program.

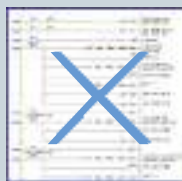

Set up high-speed

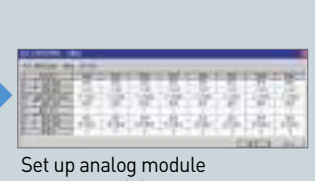

Set up analog module counter module

## Program Modularization and Task Operation

Available to run multiful programs through medulization of scan programs based on functions and author, and to operate task programs triggered by specific conditions.

Program type	Description	Number
Scan program	Scan	Executed in every scan 256-task
Task program	Initialization task	Executed only one time when power turns on 1
	Time driven task	Executed with a constant time interval specified in parameter setting 32
	Internal task	Executed by internal condition 32
	External interrupt task	Executed by external interrupt input 32

IEC standard language (XGI): LD, SFC, ST

Ladder Diagram



SFC

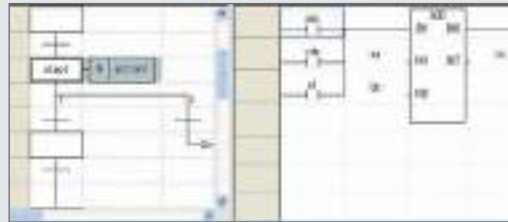

ST

```

// Network 1
LD I0.0
AND I0.1
OR I0.2
R S0.0, S0.0
// Network 2
LD S0.0
AND T1
R S0.0, S0.0
// Network 3
LD S0.0
AND T1
R S0.1, S0.1
// Network 4
LD S0.1
AND T2
R S0.1, S0.1
// Network 5
LD S0.1
AND T2
R S0.2, S0.2
// Network 6
LD S0.2
AND T3
R S0.2, S0.2
// Network 7
LD S0.2
AND T3
R S0.3, S0.3
// Network 8
LD S0.3
AND T4
R S0.3, S0.3
// Network 9
LD S0.3
AND T4
R S0.4, S0.4
// Network 10
LD S0.4
AND T5
R S0.4, S0.4
// Network 11
LD S0.4
AND T5
R S0.5, S0.5
// Network 12
LD S0.5
AND T6
R S0.5, S0.5
// Network 13
LD S0.5
AND T6
R S0.6, S0.6
// Network 14
LD S0.6
AND T7
R S0.6, S0.6
// Network 15
LD S0.6
AND T7
R S0.7, S0.7
// Network 16
LD S0.7
AND T8
R S0.7, S0.7
// Network 17
LD S0.7
AND T8
R S0.8, S0.8
// Network 18
LD S0.8
AND T9
R S0.8, S0.8
// Network 19
LD S0.8
AND T9
R S0.9, S0.9
// Network 20
LD S0.9
AND T10
R S0.9, S0.9
// Network 21
LD S0.9
AND T10
R S0.10, S0.10
// Network 22
LD S0.10
AND T11
R S0.10, S0.10
// Network 23
LD S0.10
AND T11
R S0.11, S0.11
// Network 24
LD S0.11
AND T12
R S0.11, S0.11
// Network 25
LD S0.11
AND T12
R S0.12, S0.12
// Network 26
LD S0.12
AND T13
R S0.12, S0.12
// Network 27
LD S0.12
AND T13
R S0.13, S0.13
// Network 28
LD S0.13
AND T14
R S0.13, S0.13
// Network 29
LD S0.13
AND T14
R S0.14, S0.14
// Network 30
LD S0.14
AND T15
R S0.14, S0.14
// Network 31
LD S0.14
AND T15
R S0.15, S0.15
// Network 32
LD S0.15
AND T16
R S0.15, S0.15
// Network 33
LD S0.15
AND T16
R S0.16, S0.16
// Network 34
LD S0.16
AND T17
R S0.16, S0.16
// Network 35
LD S0.16
AND T17
R S0.17, S0.17
// Network 36
LD S0.17
AND T18
R S0.17, S0.17
// Network 37
LD S0.17
AND T18
R S0.18, S0.18
// Network 38
LD S0.18
AND T19
R S0.18, S0.18
// Network 39
LD S0.18
AND T19
R S0.19, S0.19
// Network 40
LD S0.19
AND T20
R S0.19, S0.19
// Network 41
LD S0.19
AND T20
R S0.20, S0.20
// Network 42
LD S0.20
AND T21
R S0.20, S0.20
// Network 43
LD S0.20
AND T21
R S0.21, S0.21
// Network 44
LD S0.21
AND T22
R S0.21, S0.21
// Network 45
LD S0.21
AND T22
R S0.22, S0.22
// Network 46
LD S0.22
AND T23
R S0.22, S0.22
// Network 47
LD S0.22
AND T23
R S0.23, S0.23
// Network 48
LD S0.23
AND T24
R S0.23, S0.23
// Network 49
LD S0.23
AND T24
R S0.24, S0.24
// Network 50
LD S0.24
AND T25
R S0.24, S0.24
// Network 51
LD S0.24
AND T25
R S0.25, S0.25
// Network 52
LD S0.25
AND T26
R S0.25, S0.25
// Network 53
LD S0.25
AND T26
R S0.26, S0.26
// Network 54
LD S0.26
AND T27
R S0.26, S0.26
// Network 55
LD S0.26
AND T27
R S0.27, S0.27
// Network 56
LD S0.27
AND T28
R S0.27, S0.27
// Network 57
LD S0.27
AND T28
R S0.28, S0.28
// Network 58
LD S0.28
AND T29
R S0.28, S0.28
// Network 59
LD S0.28
AND T29
R S0.29, S0.29
// Network 60
LD S0.29
AND T30
R S0.29, S0.29
// Network 61
LD S0.29
AND T30
R S0.30, S0.30
// Network 62
LD S0.30
AND T31
R S0.30, S0.30
// Network 63
LD S0.30
AND T31
R S0.31, S0.31
// Network 64
LD S0.31
AND T32
R S0.31, S0.31
// Network 65
LD S0.31
AND T32
R S0.32, S0.32
// Network 66
LD S0.32
AND T33
R S0.32, S0.32
// Network 67
LD S0.32
AND T33
R S0.33, S0.33
// Network 68
LD S0.33
AND T34
R S0.33, S0.33
// Network 69
LD S0.33
AND T34
R S0.34, S0.34
// Network 70
LD S0.34
AND T35
R S0.34, S0.34
// Network 71
LD S0.34
AND T35
R S0.35, S0.35
// Network 72
LD S0.35
AND T36
R S0.35, S0.35
// Network 73
LD S0.35
AND T36
R S0.36, S0.36
// Network 74
LD S0.36
AND T37
R S0.36, S0.36
// Network 75
LD S0.36
AND T37
R S0.37, S0.37
// Network 76
LD S0.37
AND T38
R S0.37, S0.37
// Network 77
LD S0.37
AND T38
R S0.38, S0.38
// Network 78
LD S0.38
AND T39
R S0.38, S0.38
// Network 79
LD S0.38
AND T39
R S0.39, S0.39
// Network 80
LD S0.39
AND T40
R S0.39, S0.39
// Network 81
LD S0.39
AND T40
R S0.40, S0.40
// Network 82
LD S0.40
AND T41
R S0.40, S0.40
// Network 83
LD S0.40
AND T41
R S0.41, S0.41
// Network 84
LD S0.41
AND T42
R S0.41, S0.41
// Network 85
LD S0.41
AND T42
R S0.42, S0.42
// Network 86
LD S0.42
AND T43
R S0.42, S0.42
// Network 87
LD S0.42
AND T43
R S0.43, S0.43
// Network 88
LD S0.43
AND T44
R S0.43, S0.43
// Network 89
LD S0.43
AND T44
R S0.44, S0.44
// Network 90
LD S0.44
AND T45
R S0.44, S0.44
// Network 91
LD S0.44
AND T45
R S0.45, S0.45
// Network 92
LD S0.45
AND T46
R S0.45, S0.45
// Network 93
LD S0.45
AND T46
R S0.46, S0.46
// Network 94
LD S0.46
AND T47
R S0.46, S0.46
// Network 95
LD S0.46
AND T47
R S0.47, S0.47
// Network 96
LD S0.47
AND T48
R S0.47, S0.47
// Network 97
LD S0.47
AND T48
R S0.48, S0.48
// Network 98
LD S0.48
AND T49
R S0.48, S0.48
// Network 99
LD S0.48
AND T49
R S0.49, S0.49
// Network 100
LD S0.49
AND T50
R S0.49, S0.49
// Network 101
LD S0.49
AND T50
R S0.50, S0.50
// Network 102
LD S0.50
AND T51
R S0.50, S0.50
// Network 103
LD S0.50
AND T51
R S0.51, S0.51
// Network 104
LD S0.51
AND T52
R S0.51, S0.51
// Network 105
LD S0.51
AND T52
R S0.52, S0.52
// Network 106
LD S0.52
AND T53
R S0.52, S0.52
// Network 107
LD S0.52
AND T53
R S0.53, S0.53
// Network 108
LD S0.53
AND T54
R S0.53, S0.53
// Network 109
LD S0.53
AND T54
R S0.54, S0.54
// Network 110
LD S0.54
AND T55
R S0.54, S0.54
// Network 111
LD S0.54
AND T55
R S0.55, S0.55
// Network 112
LD S0.55
AND T56
R S0.55, S0.55
// Network 113
LD S0.55
AND T56
R S0.56, S0.56
// Network 114
LD S0.56
AND T57
R S0.56, S0.56
// Network 115
LD S0.56
AND T57
R S0.57, S0.57
// Network 116
LD S0.57
AND T58
R S0.57, S0.57
// Network 117
LD S0.57
AND T58
R S0.58, S0.58
// Network 118
LD S0.58
AND T59
R S0.58, S0.58
// Network 119
LD S0.58
AND T59
R S0.59, S0.59
// Network 120
LD S0.59
AND T60
R S0.59, S0.59
// Network 121
LD S0.59
AND T60
R S0.60, S0.60
// Network 122
LD S0.60
AND T61
R S0.60, S0.60
// Network 123
LD S0.60
AND T61
R S0.61, S0.61
// Network 124
LD S0.61
AND T62
R S0.61, S0.61
// Network 125
LD S0.61
AND T62
R S0.62, S0.62
// Network 126
LD S0.62
AND T63
R S0.62, S0.62
// Network 127
LD S0.62
AND T63
R S0.63, S0.63
// Network 128
LD S0.63
AND T64
R S0.63, S0.63
// Network 129
LD S0.63
AND T64
R S0.64, S0.64
// Network 130
LD S0.64
AND T65
R S0.64, S0.64
// Network 131
LD S0.64
AND T65
R S0.65, S0.65
// Network 132
LD S0.65
AND T66
R S0.65, S0.65
// Network 133
LD S0.65
AND T66
R S0.66, S0.66
// Network 134
LD S0.66
AND T67
R S0.66, S0.66
// Network 135
LD S0.66
AND T67
R S0.67, S0.67
// Network 136
LD S0.67
AND T68
R S0.67, S0.67
// Network 137
LD S0.67
AND T68
R S0.68, S0.68
// Network 138
LD S0.68
AND T69
R S0.68, S0.68
// Network 139
LD S0.68
AND T69
R S0.69, S0.69
// Network 140
LD S0.69
AND T70
R S0.69, S0.69
// Network 141
LD S0.69
AND T70
R S0.70, S0.70
// Network 142
LD S0.70
AND T71
R S0.70, S0.70
// Network 143
LD S0.70
AND T71
R S0.71, S0.71
// Network 144
LD S0.71
AND T72
R S0.71, S0.71
// Network 145
LD S0.71
AND T72
R S0.72, S0.72
// Network 146
LD S0.72
AND T73
R S0.72, S0.72
// Network 147
LD S0.72
AND T73
R S0.73, S0.73
// Network 148
LD S0.73
AND T74
R S0.73, S0.73
// Network 149
LD S0.73
AND T74
R S0.74, S0.74
// Network 150
LD S0.74
AND T75
R S0.74, S0.74
// Network 151
LD S0.74
AND T75
R S0.75, S0.75
// Network 152
LD S0.75
AND T76
R S0.75, S0.75
// Network 153
LD S0.75
AND T76
R S0.76, S0.76
// Network 154
LD S0.76
AND T77
R S0.76, S0.76
// Network 155
LD S0.76
AND T77
R S0.77, S0.77
// Network 156
LD S0.77
AND T78
R S0.77, S0.77
// Network 157
LD S0.77
AND T78
R S0.78, S0.78
// Network 158
LD S0.78
AND T79
R S0.78, S0.78
// Network 159
LD S0.78
AND T79
R S0.79, S0.79
// Network 160
LD S0.79
AND T80
R S0.79, S0.79
// Network 161
LD S0.79
AND T80
R S0.80, S0.80
// Network 162
LD S0.80
AND T81
R S0.80, S0.80
// Network 163
LD S0.80
AND T81
R S0.81, S0.81
// Network 164
LD S0.81
AND T82
R S0.81, S0.81
// Network 165
LD S0.81
AND T82
R S0.82, S0.82
// Network 166
LD S0.82
AND T83
R S0.82, S0.82
// Network 167
LD S0.82
AND T83
R S0.83, S0.83
// Network 168
LD S0.83
AND T84
R S0.83, S0.83
// Network 169
LD S0.83
AND T84
R S0.84, S0.84
// Network 170
LD S0.84
AND T85
R S0.84, S0.84
// Network 171
LD S0.84
AND T85
R S0.85, S0.85
// Network 172
LD S0.85
AND T86
R S0.85, S0.85
// Network 173
LD S0.85
AND T86
R S0.86, S0.86
// Network 174
LD S0.86
AND T87
R S0.86, S0.86
// Network 175
LD S0.86
AND T87
R S0.87, S0.87
// Network 176
LD S0.87
AND T88
R S0.87, S0.87
// Network 177
LD S0.87
AND T88
R S0.88, S0.88
// Network 178
LD S0.88
AND T89
R S0.88, S0.88
// Network 179
LD S0.88
AND T89
R S0.89, S0.89
// Network 180
LD S0.89
AND T90
R S0.89, S0.89
// Network 181
LD S0.89
AND T90
R S0.90, S0.90
// Network 182
LD S0.90
AND T91
R S0.90, S0.90
// Network 183
LD S0.90
AND T91
R S0.91, S0.91
// Network 184
LD S0.91
AND T92
R S0.91, S0.91
// Network 185
LD S0.91
AND T92
R S0.92, S0.92
// Network 186
LD S0.92
AND T93
R S0.92, S0.92
// Network 187
LD S0.92
AND T93
R S0.93, S0.93
// Network 188
LD S0.93
AND T94
R S0.93, S0.93
// Network 189
LD S0.93
AND T94
R S0.94, S0.94
// Network 190
LD S0.94
AND T95
R S0.94, S0.94
// Network 191
LD S0.94
AND T95
R S0.95, S0.95
// Network 192
LD S0.95
AND T96
R S0.95, S0.95
// Network 193
LD S0.95
AND T96
R S0.96, S0.96
// Network 194
LD S0.96
AND T97
R S0.96, S0.96
// Network 195
LD S0.96
AND T97
R S0.97, S0.97
// Network 196
LD S0.97
AND T98
R S0.97, S0.97
// Network 197
LD S0.97
AND T98
R S0.98, S0.98
// Network 198
LD S0.98
AND T99
R S0.98, S0.98
// Network 199
LD S0.98
AND T99
R S0.99, S0.99
// Network 200
LD S0.99
AND T100
R S0.99, S0.99

```

ST features

- High-level Language
- Fit for the complicate algorithm
- Various open source (Compatibility)
- Easy data processing
- Convenient text editor

User defined Function block (XGI)

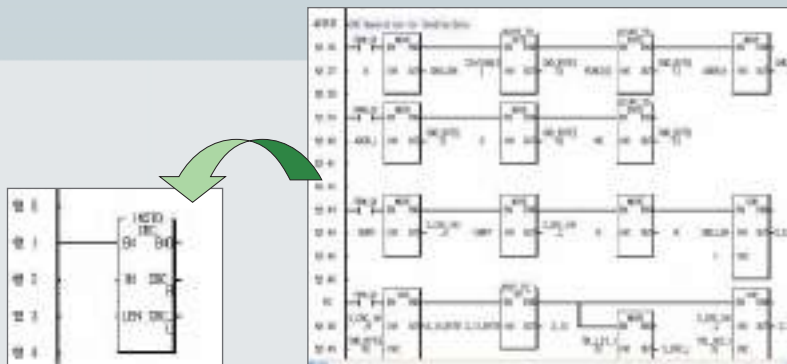

- Standardize the program using function or function block
- Register the standardized program as a library file and reuse the library for another project



XGF-ACF2

POWER

XGI-CPU0N

RUN/STOP

SEM

ERR

P.S

BAT

CHK

XGL-PMEC

RE P-PMW RUN

CPG STATE ERR

XGF-DV4A

RUN

XGL-EIPT

IF PDP SW RUN

PACT 1 LAM

PACT 2 LAM

XGF-PM8B

AX1 AX5 RDY

AX2 AX6 RUN

AX3 AX7 ACT

AX4 AX8

XGQ-RY2A

OS DOWN

STATION NUMBER

K1E K1

ENC1A+

ENC1A-

ENC1B+

ENC1B-

ENC2+

ENC2-

ENC3+

ENC3-

ENC4+

ENC4-

ENC5+

ENC5-

T81



# CPU & System Configuration

XGT series contain variety of CPU types for customized solutions which support wide coverage from small / middle- to large size-system control.

Contents	16 CPU module
	24 I/O module



## XGK CPU (LS Standard)

Premium CPU for high-speed and large scale application



### XGK-CPUUN

- Program capacity: 256K steps
- I/O points: 6,144
- I/O device point: 65,536 (Remote I/O)
- Processing speed: 8.5ns/step



### XGK-CPUHN

- Program capacity: 128K steps
- I/O points: 6,144
- I/O device point: 65,536 (Remote I/O)
- Processing speed: 8.5ns/step



### XGK-CPUSN

- Program capacity: 64K steps
- I/O points: 3,072
- I/O device point: 65,536 (Remote I/O)
- Processing speed: 8.5ns/step



### XGK-CPUU (Ultra capacity)

- Program capacity: 128K steps
- I/O points: 6,144
- I/O device point: 32,768 (Remote I/O)
- Processing speed: 28ns/step



### XGK-CPUH (High performance)

- Program capacity: 64K steps
- I/O points: 6,144
- I/O device point: 32,768 (Remote I/O)
- Processing speed: 28ns/step



### XGK-CPUA (Advanced)

- Program capacity: 32K steps
- I/O points: 3,072
- I/O device point: 32,768 (Remote I/O)
- Processing speed: 28ns/step

## General sequence controller PLC CPU



### XGK-CPUS (Standard)

- Program capacity: 32K steps
- I/O points: 3,072
- I/O device point: 32,768 (Remote I/O)
- Processing speed: 84ns/step



### XGK-CPUE (Economic)

- Program capacity: 16K step
- I/O point: 1,536
- I/O device point: 32,768 (Remote I/O)
- Processing speed: 84ns/step

## XGI CPU (IEC Standard)

Premium CPU for high-speed and large scale application



### XGI-CPUUN

- Program capacity: 2MBytes
- I/O points: 6,144
- I/O device point: 131,072 (Remote I/O)
- Processing speed: 8.5ns/step



### XGI-CPUU

- Program capacity: 1MBytes
- I/O points: 6,144
- I/O device point: 131,072 (Remote I/O)
- Processing speed: 28ns/step



### XGI-CPUH

- Program capacity: 512KBytes
- I/O points: 6,144
- I/O device point: 131,072 (Remote I/O)
- Processing speed: 28ns/step

## General sequence controller PLC CPU



### XGI-CPUS (IEC Standard)

- Program capacity: 128KBytes
- I/O points: 3,072
- I/O device point: 32,768 (Remote I/O)
- Processing speed: 28ns/step



### XGI-CPUE (IEC Standard)

- Program capacity: 64KBytes
- I/O points: 1,536
- I/O device point: 32,768 (Remote I/O)
- Processing speed: 84ns/step



## CPU Module System composition

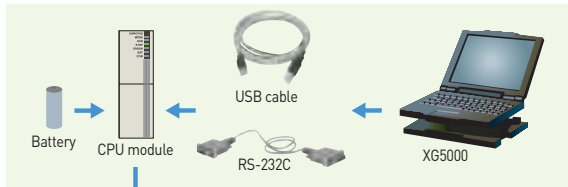

Item	Type	Description
Expansion cable	XGC-E041	Expansion cable 0.4m
	XGC-E061	Expansion cable 0.6m
	XGC-E121	Expansion cable 1.2m
	XGC-E301	Expansion cable 3.0m
	XGC-E501	Expansion cable 5.0m
	XGC-E102	Expansion cable 10m
	XGC-E152	Expansion cable 15m
Expansion terminator	XGT-TERA	Expansion terminator

Item	Main base	Expansion base
4 slot	XGB-M04A	XGB-E04A
6 slot	XGB-M06A	XGB-E06A
8 slot	XGB-M08A	XGB-E08A
12 slot	XGB-M12A	XGB-E12A

### XG5000 Cable (RS-232C)

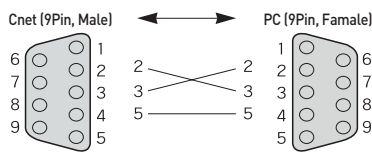

	CPU module	I/O point
XGK	XGK-CPUH,CPUU, CPUHN, CPUUN	6,144
	XGK-CPUS,CPUA, CPUSN	3,072
	XGK-CPUE	1,536
XGI	XGI-CPUUN, CPUU/D, CPUU, CPUH	6,144
	XGI-CPUS	3,072
	XGI-CPUE	1,536

CPU Connecting Cable	
USB 301A	USB downloading cable
K1C-050A	RS-232C downloading cable

Item	Type	Description
USB cable	USB-301A	USB downloading cable
RS-232C cable	K1C-050A	RS-232C downloading cable

Item	Input module		
	AC110V	AC220V	DC24V
8 points	-	XGI-A21A	XGI-D21A
	XGI-A12A	-	XGI-D22A
16 points	-	-	XGI-D22B
	-	-	XGI-D24A
32 points	-	-	XGI-D24B
	-	-	XGI-D28A
64 points	-	-	XGI-D28B

Power module			
AC	Free Voltage	XGP-ACF1	DC5V 3A DC24V 0.6A
		XGP-ACF2	DC5V 6A
	220V	XGP-AC23	DC5V 8.5A
DC		XGP-DC42	DC5V 6A

Item	Output module		
	Relay	Triac	Transistor
8 points	XGQ-RY1A	-	-
	XGQ-RY2A	XGQ-SS2A	XGQ-TR2A
16 points	XGQ-RY2B	-	XGQ-TR2B
	-	-	XGQ-TR4A
32 points	-	-	XGQ-TR4B
	-	-	XGQ-TR8A
64 points	-	-	XGQ-TR8B

Item	Input/Output mixed module	
	16-point DC input	16-point TR output

Item	Special module	
	Relay	Triac
Analog input	XGF-AV8A	Voltage input type, 8Ch
	XGF-AC8A	Current input type, 8Ch
	XGF-AD8A	Voltage/ Current input, 8Ch
	XGF-AD4S	Voltage/ Current input, 4Ch (Isolated)
	XGF-AD16A	Voltage/ Current input, 16Ch
Analog output	XGF-AW4S	2-wire, Voltage/ Current input, 4Ch (Isolated)
	XGF-DV4A	Voltage output type, 4Ch
	XGF-DC4A	Current output type, 4Ch
	XGF-DV8A	Voltage output type, 8Ch
	XGF-DC8A	Current output type, 8Ch
Analog Input/Output	XGF-DV4S	Voltage output, 4Ch (Isolated)
	XGF-DC4S	Current output, 4Ch (Isolated)
High-speed counter	XGF-AH6A	Input: 4ch, Voltage/ Current Output: 2Ch Voltage/ Current
	XGF-H02A	Pulse (OC) input type, 2Ch
Positioning	XGF-HD2A	Pulse (LD) input type, 2Ch
	XGF-PO1A-PO3A	Open collector, 1-3axis
	XGF-PD1A-PD3A	Line drive, 1-3axis
	XGF-PO1H-PO4H	Open collector, 1-4axis
	XGF-PD1H-PD4H	Line drive, 1-4axis
Positioning (Network Type)	XGF-PN8A	LS Standard EtherCAT Net. 8axis
	XGF-PN8B	Standard EtherCAT Net. 8axis
Temperature control	XGF-TC4S	Thermocouple input, 4Ch
	XGF-RD4A	RTD input, 4Ch
	XGF-RD4S	RTD input, 4Ch (Insulated)
Temperature controller	XGF-TC4UD	Input: 4ch.(Voltage/Current, RTD/TC) Output: 8ch.(TR/Current) Controller: 4 loops
	XGF-TC4RT	Input: 4ch.(RTD) Output: 4ch.(TR) Controller: 4 loops
Event input	XGF-S0EA	DC24V, 32points
Data log	XGF-DL16A	USB2.0,CF2001,Max16Gbyte, 32 points 1 slot(Input 22 points, output 10 points)

Communication module		
RAPIenet	XGL-EIMT	RAPIenet Twisted fair 2Ch
	XGL-EIMH	RAPIenet Fiber optic/Twisted fair 1Ch
	XGL-EIMF	RAPIenet Fiber optic 2Ch
	XGL-ES4T	RAPIenet Switch, 4Ch
	XGL-EIMT	RAPIenet Twisted fair 2Ch For PC
Cnet	XOL-EIMF	RAPIenet Fiber optic 2Ch For PC
	XGL-CH2B	RS-232C/RS-422
	XGL-C22B	RS-232C, 2Ch
Ethernet (Open)	XGL-C42B	RS-422, 2Ch
	XGL-EFMTB	Fiber optic, Master, SC type
	XGL-EFMFB	Twisted pair, Master, RJ-45
	XGL-ESHF	Fast Ethernet, Industrial Ring module
	XGL-EHST	Fast Ethernet, Switching hub
Ethernet (Dedicated)	XGL-EDMT	Fiber optic, Master, SC type
	XGL-EDMT	Twisted pair, Master, RJ-45
Rnet	XGL-EIPT	Industrial Ethernet, 2ports
EtherNet/IP	XGL-RMEB	Rnet, Master, TP
DeviceNet	XGL-DMEB	DeviceNet, Master
	XGL-PMEB	Profibus-DP, Master
	XGL-PSRA	Profibus-DP, Slave, Remote Inter face
Profibus-DP	XGL-PSEA	Profibus-DP, Slave
	XGL-FMEA	Dedicated network
BACnet/IP	XGL-BIPT	BACnet client/server



## Specifications

Item	Description	Standard			
Ambient temperature	0 ~ 55 °C				
Storage temperature	-25 ~ +70 °C				
Ambient humidity	5 ~ 95%RH, (Non-condensing)				
Storage humidity	5 ~ 95%RH, (Non-condensing)				
Vibration resistance	Occasional vibration		10 times each direction (X, Y and Z)	IEC 61131-2	
	Frequency	Acceleration			Pulse width
	10 ≤ f < 57Hz	-			0.075mm
	57 ≤ f < 150Hz	9.8m/s <sup>2</sup> {1G}			-
	Frequency	Acceleration			Pulse width
	10 ≤ f < 57Hz	-			0.035mm
Shock resistance	<ul style="list-style-type: none"> <li>• Peak acceleration: 147 m/s{15G}</li> <li>• Duration: 11ms</li> <li>• Half-sine, 3 times each direction per each axis</li> </ul>		IEC 61131-2		
Noise resistance	Square wave impulse noise	± 1,500 V	LSIS Standard		
	Electrostatic discharge	± 4kV	IEC 61131-2, IEC 61000-4-2		
	Radiated electromagnetic field noise	27 ~ 500 MHz, 10 V/m	IEC 61131-2, IEC 61000-4-3		
	Fast transient / Burst noise	0.25kV	IEC 61131-2, IEC 61000-4-4		
Operating Ambience	Free from corrosive gases and excessive dust				
Altitude	Up to 2,000m				
Pollution degree	Less than equal to 2				
Cooling	Air-cooling				

\* Pollution degree 2 is nonconductive pollution of the sort where occasionally a temporary conductivity caused by condensation must be expected.

## XGK

Item	Description			Remarks
	XGK-CPUUN	XGK-CPUHN	XGK-CPUSN	
Operation method	Cyclic execution of stored program, Time-driven interrupt, Process-driven interrupt			
I/O control method	Batch processing by scan synchronization (Refresh), Direct input/output by instruction			
Program language	Ladder diagram, Instruction list, SFC(Sequential Function Chart), ST(Structured Text)			
Number of instructions	Basic	40		
	Application	700		
Processing speed	LD	0.0085μs/Step		
	MOVE	0.255μs/Step		
	Real number operation	± : 182.2ns (S), 327.3ns (D)		S: Single real number D: Double real number
		× : 336ns (S), 427ns (D)		
Program capacity	256Kstep (1,024KB)	128Kstep (512KB)	64Kstep (256KB)	
I/O points (available to install)	6,144	6,144	3,072	
Data area	P	P00000 ~ P4095F(65,536 points)		
	M	M00000 ~ M4095F(65,536 points)		
	K	K00000 ~ K4095F(65,536 points)		
	L	L0000 ~ L11263F(180,224 points)		
	F	F0000 ~ F4095F(65,536 points)		
	T	100ms : T0000 - T2999		Timer (Adjustable)
		10ms : T3000 - T5999		
		1ms : T6000 - T7999		
		0.1ms : T8000 - T8191		
	C	C0000 ~ C4095		
	S	S00.00 ~ S255.99		
	D	D0000 ~ D524287		D0000 ~ D262143
U	U0.0-U7F.31		U0.0-U3F.31	Special module data refresh area
Z	256 points			
N	N00000 ~ N21503			
R	16 block	8 block	2 block	32K word per 1 block (R0 ~ R32767)
Flash area	2M byte, 32 blocks			Controllable by R device
Program type	Total program	256		
	Initialization	1 (INT)		
	Time-driven	32		
	Internal	32		
Operation mode	RUN, STOP, DEBUG			
Self-diagnosis	Execution, Delay, Memory error, I/O error, Battery error, Power error			Modbus slave
Programming port	RS-232C (1Ch), USB (1Ch)			
Data retention at power failure	Set "retain" at data declaration			
Max. expansion stage	7		3	Total length 15m
Current consumption (mA)	960			
Weight (Kg)	0.12			

XGK

Item	Description					Remarks
	XGK-CPUU	XGK-CPUH	XGK-CPUA	XGK-CPUS	XGK-CPUE	
Operation method	Cyclic execution of stored program, Time-driven interrupt, Process-driven interrupt					-
I/O control method	Batch processing by scan synchronization (Refresh), Direct input/output by instruction					-
Program language	Ladder diagram, Instruction list, SFC (Sequential Function Chart), ST (Structured Text)					-
Number of instructions	Basic	40				-
	Application	700				-
Processing speed	LD	0.028 μs/Step		0.084 μs/Step		-
	MOVE	0.084 μs/Step		0.252 μs/Step		-
	Real number operation	±: 0.602 μs (S), 1.078 μs (D)		±: 1.442 μs (S), 2.87 μs (D)		S: Single real number D: Double real number
		×: 1.106 μs (S), 2.394 μs (D) ÷: 1.134 μs (S), 2.66 μs (D)		×: 1.948 μs (S), 4.186 μs (D) ÷: 1.442 μs (S), 4.2 μs (D)		
Program capacity	128Kstep(512KB)	64Kstep(256KB)	32Kstep(128KB)		16Kstep(64KB)	-
I/O points (available to install)	6,144		3,072		1,536	-
Data area	P	P00000 - P2047F(32,768 points)				-
	M	M00000 - M2047F(32,768 points)				-
	K	K00000 - K2047F(32,768 points)				-
	L	L0000 - L11263F(180,224 points)				-
	F	F0000 - F2047F(32,768 points)				-
	T	10ms : T1000 - T1499 1ms : T2000 - T2047		100ms : T0000 - T0999 1ms : T1500 - T1999		Change area is available by Parameter setting
	C	C0000 - C2047				-
	S	S00.00 - S127.99				-
	D	D0000 - D32,767				-
	U	U0.0-U7F.31	U0.0-U3F.31	U0.0-U3F.31	U0.0-U1F.31	Special module data refresh area
	Z	128 points				-
	N	N00000 - N21503				-
	R	2 block		1 block		32K word per 1 block (R0 - R32767)
Flash area	2M byte, 32 blocks					Controllable by R device
Program type	Total program	256				-
	Initialization	1 (_INT)				-
	Time-driven	32				-
	Internal	32				-
Operation mode	RUN, STOP, DEBUG					-
Self-diagnosis	Execution, Delay, Memory error, I/O error, Battery error, Power error					Modbus slave
Programming port	RS-232C (1Ch), USB (1Ch)					-
Data retention at power failure	Set "retain" at data declaration					-
Max. expansion stage	7	3		1		Total length 15m
Current consumption (mA)	960		940		-	-
Weight (Kg)	0.12					-



XGI

Item	XGI-CPUUN	XGI-CPUU/D	XGI-CPUU	XGI-CPUH	XGI-CPUS	XGI-CPUE	Remarks	
Operation system	Reiterative operation, fixed cycle operation, constant scan							
I/O Control system	Scan synchronous batch processing system(refresh system), direct system by command							
Program language	Ladder Diagram, SFC (Sequential Function Chart), ST (Structured Text)							
Operation processing speed (basic command)	Operator	18						
	Basic function	136 types + real number operation function						
	Basic function block	43						
	Dedicated function block	Dedicated function blocks by special function modules, communication dedicated function block(P2P)						
	Basic	0.0085 $\mu$ s /step	0.028 $\mu$ s /step			0.084 $\mu$ s /step		
	MOVE	0.255 $\mu$ s /step	0.084 $\mu$ s /step			0.252 $\mu$ s /step		
Real number operation	$\pm$ : 0.119 $\mu$ s(S), 0.281 $\mu$ s(D) $\times$ : 0.272 $\mu$ s(S), 0.680 $\mu$ s(D) $\div$ : 0.281 $\mu$ s(S), 0.685 $\mu$ s(D)	$\pm$ : 0.392 $\mu$ s(S), 0.924 $\mu$ s(D) $\times$ : 0.896 $\mu$ s(S), 2.240 $\mu$ s(D) $\div$ : 0.924 $\mu$ s(S), 2.254 $\mu$ s(D)			$\pm$ : 1.442 $\mu$ s(S), 2.87 $\mu$ s(D) $\times$ : 1.948 $\mu$ s(S), 4.186 $\mu$ s(D) $\div$ : 1.442 $\mu$ s(S), 4.2 $\mu$ s(D)	S: Single real number D: Double real number		
Program memory capacity	2M	1M	512KB	128KB	64KB			
I/O points (installable)	6,144 points			3,072 points	1,536 points			
Max. I/O memory contact	131,072 points			32,768 points				
Data memory	Symbolic variable area(A)	1024KB (max. 512KB retain settable)	512KB (max. 256KB retain settable)		128KB (max. 64KB retain settable)	64KB (max. 32KB retain settable)		
	I variable(I)	16KB			4KB			
	Q variable(Q)	16KB			4KB			
	Direct variable	M	512KB (max. 256KB retain settable)	256KB (max. 128KB retain settable)		64KB (max. 32KB retain settable)	32KB (max. 16KB retain settable)	
		R	64KB $\times$ 16block		64KB $\times$ 2block	64KB $\times$ 1block	32KB $\times$ 1block	
		W	1,024KB		128KB	64KByte	32KByte	R
	Flag variable	F	8KB		4KB			System flag
		K	16KB			4KB		PID flag
		L	22KB					High speed link flag
		N	42KB					P2PParameters
U		8KB		4KB		2KB	Analog data Refresh	
Flash area	2MB, 32block					1MB, 16block		
Timer	No point limit Time range: 0.001~ 4,294,967.295 second(1,193 hours)					20 bytes of symbolic variable area per point		
Counter	No point limit Coefficient range : 64 bit expression					8 bytes of symbolic variable area per point		
Program structure	Total no. of programs	256						
	Initialization task	1						
	Fixed cycle task	32						
	Internal device task	32						
Operation mode	RUN, STOP, DEBUG							
Restart mode	Cold, Warm							
Self diagnosis	Operation delay monitoring, memory fault, I/O fault, battery fault, power fault and etc							
Data protection in case of power failure	Retain area setting by basic parameters							
Max. base extension	7			3	1	Total length 15m		
Current consumption (mA)	960mA			940mA				
Weight (kg)	0.12kg							

**XGK/XGI  
CPU built-in  
Ethernet  
specification**

Item	XGK-CPUSN, CPUHN, CPUUN / XGI-CPUUN	Remarks	
Ethernet	Feature	1 Port	-
		10/100BASE-TX	-
		Auto negotiation (Full-duplex and half duplex)	-
		Auto MDIX Crossover	-
		Max. Support 4 channel	Support 8Kbyte each send and receive channel
		Max. Distance between nodes : 100m	-
		Max. Protocol size : 1500Byte	IP Fragmentation is not supported.
	Cable	UTP, STP, FTP cables is available	FTP, STP is recommended to prevent noise
		Setting communication parameters with XG5000	-
	Service	Loader service (XG5000 connection) supported	Remote stage 1 connection with PLC is available
		LS protocol(XGT) supported.	Server function & TCP supported.
		Other company's protocol (Modbus TCP/IP) supported	UDP not supported.



### XGK system configuration

Item	XGK-CPUE	XGK-CPUS, CPUSN	XGK-CPUA	XGK-CPUH, CPUHN	XGK-CPUU, CPUUN																																																						
Max. expansion stage	1 Stage	3 Stage	3 Stage	7 Stage	7 Stage																																																						
Max. installation of module	24 Module	48 Module	48 Module	96 Module	96 Module																																																						
Max. number of I/O point	1,536 Points	3,072 Points	3,072 Points	6,144 Points	6,144 Points																																																						
Max. expansion distance	15m																																																										
Assignment of I/O number (Fixed)	<ul style="list-style-type: none"> <li>• 64 points are assigned to each slot of base regardless of installation of module.</li> <li>• I/O numbers equivalent to 12 slots are assigned to a base.</li> <li>• The starting number of base 0 is P0000.</li> </ul> <ul style="list-style-type: none"> <li>• Refer to the following figure regarding the I/O number assignment of 12 slots</li> </ul> <table border="1"> <thead> <tr> <th>Slot number:</th> <th>0</th> <th>1</th> <th>2</th> <th>3</th> <th>4</th> <th>5</th> <th>6</th> <th>7</th> <th>8</th> <th>9</th> <th>10</th> <th>11</th> </tr> </thead> <tbody> <tr> <td>Power</td> <td></td> <td></td> <td>16 points</td> <td>16 points</td> <td>32 points</td> <td>64 points</td> <td>16 points</td> <td>32 points</td> <td>32 points</td> <td>64 points</td> <td>32 points</td> <td>16 points</td> <td>32 points</td> </tr> <tr> <td>CPU</td> <td></td> <td></td> <td></td> <td></td> <td></td> <td></td> <td></td> <td></td> <td></td> <td></td> <td></td> <td></td> <td></td> </tr> <tr> <td></td> <td>P00 P0F</td> <td>P40 P7F</td> <td>P80 P11F</td> <td>P120 P15F</td> <td>P160 P19F</td> <td>P200 P23F</td> <td>P240 P27F</td> <td>P280 P31F</td> <td>P320 P35F</td> <td>P360 P39F</td> <td>P400 P43F</td> <td>P440 P47F</td> </tr> </tbody> </table>					Slot number:	0	1	2	3	4	5	6	7	8	9	10	11	Power			16 points	16 points	32 points	64 points	16 points	32 points	32 points	64 points	32 points	16 points	32 points	CPU															P00 P0F	P40 P7F	P80 P11F	P120 P15F	P160 P19F	P200 P23F	P240 P27F	P280 P31F	P320 P35F	P360 P39F	P400 P43F	P440 P47F
Slot number:	0	1	2	3	4	5	6	7	8	9	10	11																																															
Power			16 points	16 points	32 points	64 points	16 points	32 points	32 points	64 points	32 points	16 points	32 points																																														
CPU																																																											
	P00 P0F	P40 P7F	P80 P11F	P120 P15F	P160 P19F	P200 P23F	P240 P27F	P280 P31F	P320 P35F	P360 P39F	P400 P43F	P440 P47F																																															
I/O assignment (Variable)	<ul style="list-style-type: none"> <li>• I/O point is assigned automatically according to the installed module.</li> <li>• I/O parameter is used to install modules.</li> <li>• The starting number of base 0 is P0000.</li> <li>• 16 points are assigned automatically to the slot of special or communication module</li> </ul> <ul style="list-style-type: none"> <li>• Refer to the following figure regarding the I/O number assignment of 12 slots.</li> </ul> <table border="1"> <thead> <tr> <th>Slot number:</th> <th>0</th> <th>1</th> <th>2</th> <th>3</th> <th>4</th> <th>5</th> <th>6</th> <th>7</th> <th>8</th> <th>9</th> <th>10</th> <th>11</th> </tr> </thead> <tbody> <tr> <td>Power</td> <td></td> <td></td> <td>16 points</td> <td>16 points</td> <td>32 points</td> <td>64 points</td> <td>16 points</td> <td>32 points</td> <td>32 points</td> <td>64 points</td> <td>32 points</td> <td>16 points</td> <td>32 points</td> </tr> <tr> <td>CPU</td> <td></td> <td></td> <td></td> <td></td> <td></td> <td></td> <td></td> <td></td> <td></td> <td></td> <td></td> <td></td> </tr> <tr> <td></td> <td>P00 P0F</td> <td>P10 P1F</td> <td>P20 P3F</td> <td>P40 P7F</td> <td>P80 PBF</td> <td>P90 P10F</td> <td>P110 P12F</td> <td>P130 P16F</td> <td>P170 P18F</td> <td>P190 P19F</td> <td>P200 P21F</td> <td>P220 P23F</td> </tr> </tbody> </table>					Slot number:	0	1	2	3	4	5	6	7	8	9	10	11	Power			16 points	16 points	32 points	64 points	16 points	32 points	32 points	64 points	32 points	16 points	32 points	CPU														P00 P0F	P10 P1F	P20 P3F	P40 P7F	P80 PBF	P90 P10F	P110 P12F	P130 P16F	P170 P18F	P190 P19F	P200 P21F	P220 P23F	
Slot number:	0	1	2	3	4	5	6	7	8	9	10	11																																															
Power			16 points	16 points	32 points	64 points	16 points	32 points	32 points	64 points	32 points	16 points	32 points																																														
CPU																																																											
	P00 P0F	P10 P1F	P20 P3F	P40 P7F	P80 PBF	P90 P10F	P110 P12F	P130 P16F	P170 P18F	P190 P19F	P200 P21F	P220 P23F																																															

### XGI system configuration

Item	XGI-CPUU, CPUH, CPUU/D, CPUUN	XGI-CPUS	XGI-CPUE																																																					
Max. expansion stage	7 Stage	3 Stage	1 Stage																																																					
Max. installation of module	96 Module	48 Module	24 Module																																																					
Max. number of I/O point	16 point : 1,536 Points 32 point : 3,072 Points 64 point : 6,144 Points	16 point : 768 Points 32 point : 1,536 Points 64 point : 3,072 Points	16 point : 384 Points 32 point : 768 Points 64 point : 1,536 Points																																																					
Max. expansion distance	15m																																																							
I/O assignment	<ul style="list-style-type: none"> <li>• 64 points are assigned to each slot of base regardless of installation of module.</li> <li>• No limit in installation of special module</li> <li>• Special module is controlled by function block and the memory assignment is done automatically</li> </ul> <ul style="list-style-type: none"> <li>• Refer to the following figure regarding the I/O assignment of 12 slots</li> </ul> <table border="1"> <thead> <tr> <th>Slot number:</th> <th>0</th> <th>1</th> <th>2</th> <th>3</th> <th>4</th> <th>5</th> <th>6</th> <th>7</th> <th>8</th> <th>9</th> <th>10</th> <th>11</th> </tr> </thead> <tbody> <tr> <td>Power</td> <td></td> <td></td> <td>16 points</td> <td>16 points</td> <td>32 points</td> <td>64 points</td> <td>16 points</td> <td>32 points</td> <td>32 points</td> <td>64 points</td> <td>32 points</td> <td>16 points</td> <td>32 points</td> </tr> <tr> <td>CPU</td> <td></td> <td></td> <td></td> <td></td> <td></td> <td></td> <td></td> <td></td> <td></td> <td></td> <td></td> <td></td> </tr> <tr> <td></td> <td></td> <td></td> <td></td> <td></td> <td></td> <td></td> <td></td> <td></td> <td></td> <td></td> <td></td> <td></td> </tr> </tbody> </table> <p>           %I × 0.8.0-31            %Q × 0.9.0-15            %Q × 0.10.0-31            %Q × 0.11.0-31         </p>			Slot number:	0	1	2	3	4	5	6	7	8	9	10	11	Power			16 points	16 points	32 points	64 points	16 points	32 points	32 points	64 points	32 points	16 points	32 points	CPU																									
Slot number:	0	1	2	3	4	5	6	7	8	9	10	11																																												
Power			16 points	16 points	32 points	64 points	16 points	32 points	32 points	64 points	32 points	16 points	32 points																																											
CPU																																																								

### Expansion system composition

1. The following figure is the example of expansion system with the fixed I/O point type of XGK-CPUH.
2. The address of I/O point is adjustable by XG5000 parameter.

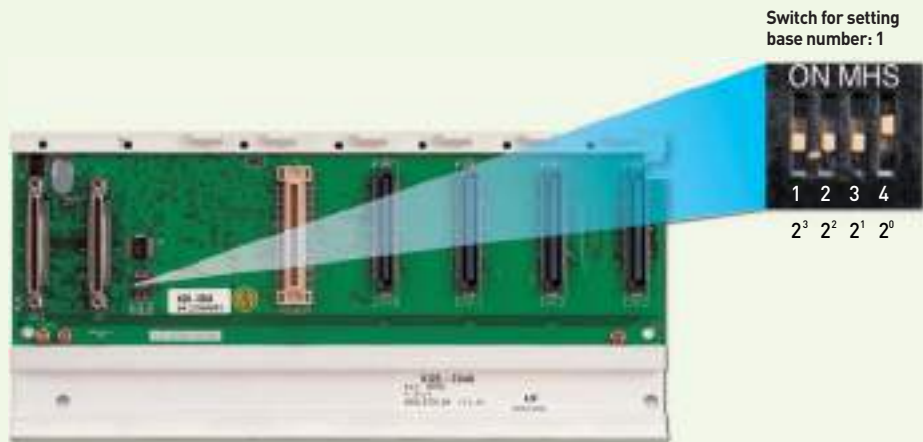

The lowest expansion base should be connected to the upper stage with expansion terminator(XGF-TERA).

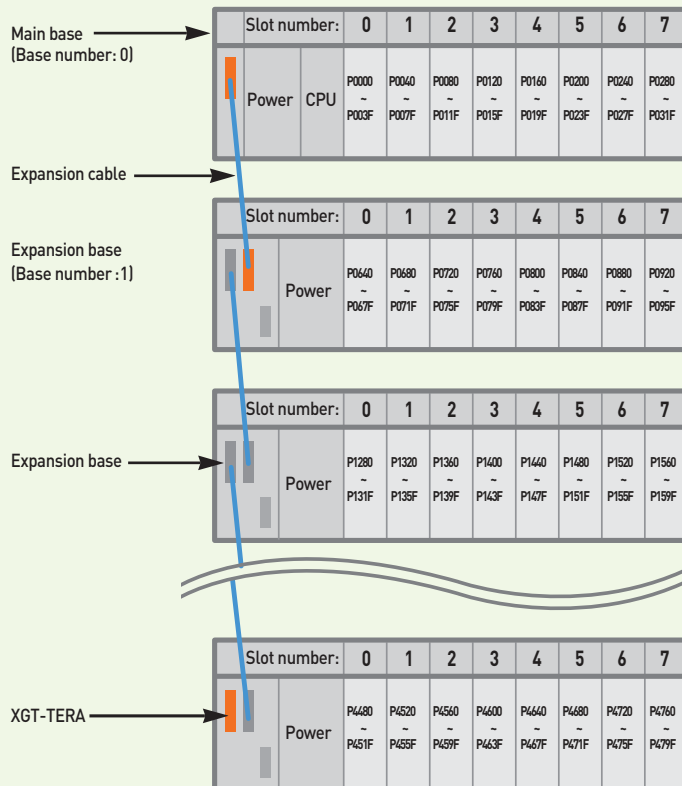

XGT-TERA should be installed at the end of the last expansion base.



## Features

- 8, 16, 32, 64 points I/O module
- Operation monitoring by LED display
- Easy maintenance: Terminal block type, one-touch installation of module



## Input module specifications

Item		DC input						AC input			
Type		XGI-D21A	XGI-D22A	XGI-D22B	XGI-D24A	XGI-D24B	XGI-D28A	XGI-D28B	XGI-A12A	XGI-A21A	XGI-A21C
Input point		8	16		32		64		16	8	8
Rated input voltage		DC24V						AC100-120V		Free voltage	DC100/240V
Rated input current		4mA						8mA	17mA	17mA	
ON voltage/current		19V or more / 3mA or less						AC80V or more / 5mA or less	AC130V or more / 10mA or less	AC80V or more / 5mA or less	
OFF voltage/current		DC11V or more / 1.7mA or less						AC80V or more / 5mA or less	AC60V or more / 2mA or less	AC30V or more / 1mA or less	
Response	Off→On	1ms/5ms/10ms/20ms/70ms (set by CPU parameter) Initial value: 3ms						15mA or less			
	On→Off	1ms/5ms/10ms/20ms/70ms (set by CPU parameter) Initial value: 3ms						25mA or less			
Common (COM)		8 points/COM	16 points/COM	32 points/COM			16 points/COM	8 points/COM	1 points/COM		
Insulation method		Photocoupler						Photocoupler			
Current consumption (mA)		20	30	50		60		30	20	20	
Weight (Kg)		0.1	0.12	0.1		0.15		0.13	0.13	0.13	

## Output module specifications

Item		Relay			Transistor						Triac	
Type		XGQ-RY1A	XGQ-RY2A	XGQ-RY2B	XGQ-TR1C	XGQ-TR2A	XGQ-TR2B	XGQ-TR4A	XGQ-TR4B	XGQ-TR8A	XGQ-TR8B	XGQ-SS2A
Output point		8	16		8	16		32		64		16
Rated input voltage		DC12/24V, AC110/220V			DC12/24V						AC110/220V	
Rated input current	1 Point	2A			2A	0.5A	0.1A			0.6A		
	Common	5A			0.1A	4A	2A			4A		
Response time	Off→On	10ms or less			3ms or less	1ms or less			1ms or less			
	On→Off	12ms or less			10ms or less	1ms or less			0.5cycle +1ms or less			
Common (COM)		1 point/COM	16 points/COM	1 points/COM	32 points/COM						16 points/COM	
Insulation method		Relay			Photocoupler							
Current consumption (mA)		260	500		100	70	130		230	300		
Weight (Kg)		0.13	0.17	0.19	0.11	0.11	0.1		0.15	0.2		
Surge killer		-			Varistor	Zener diode						Varistor
External power supply		-			DC12/24V	DC						-

Note) B1, B2 of 32, 62 points terminal (connector) are shorted inside of the product.



Wiring diagram for input modules

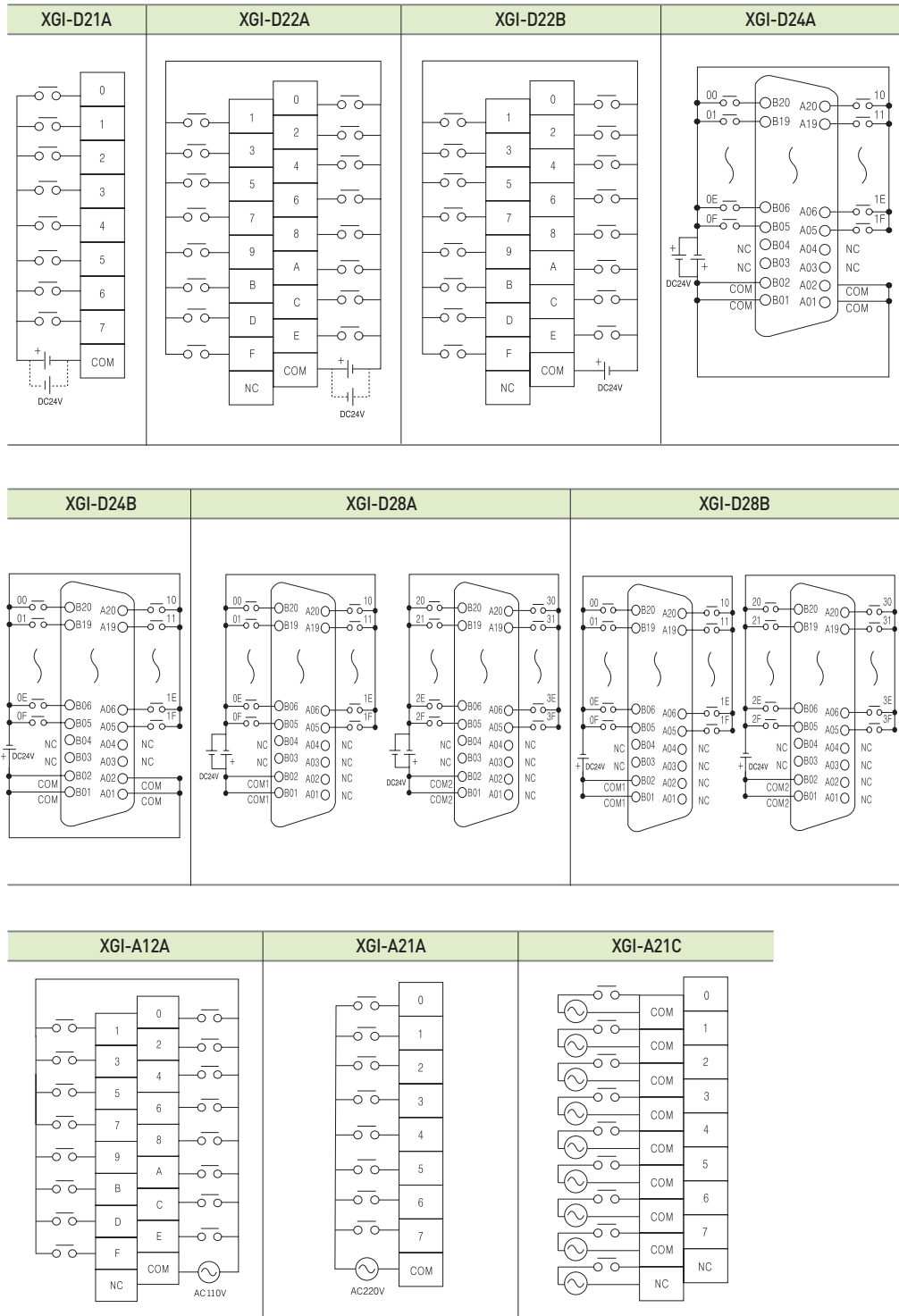

## Wiring diagram for output modules

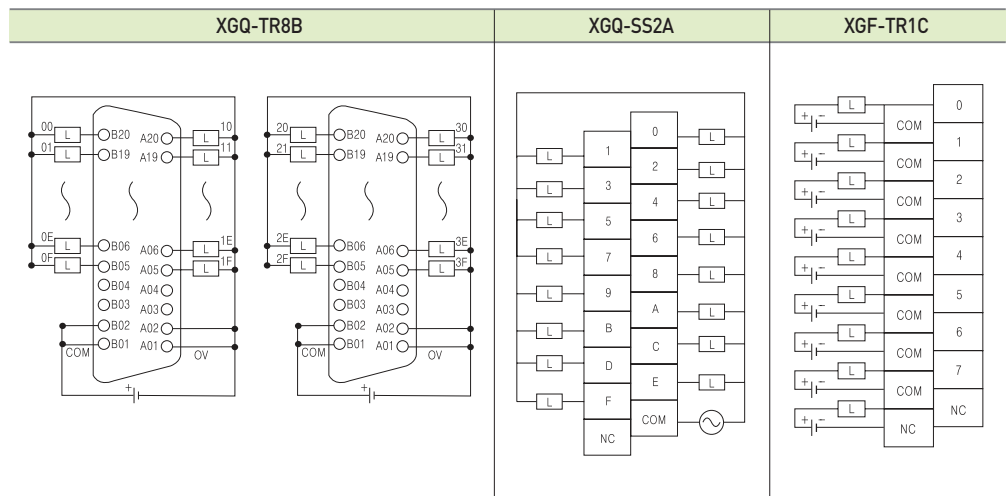
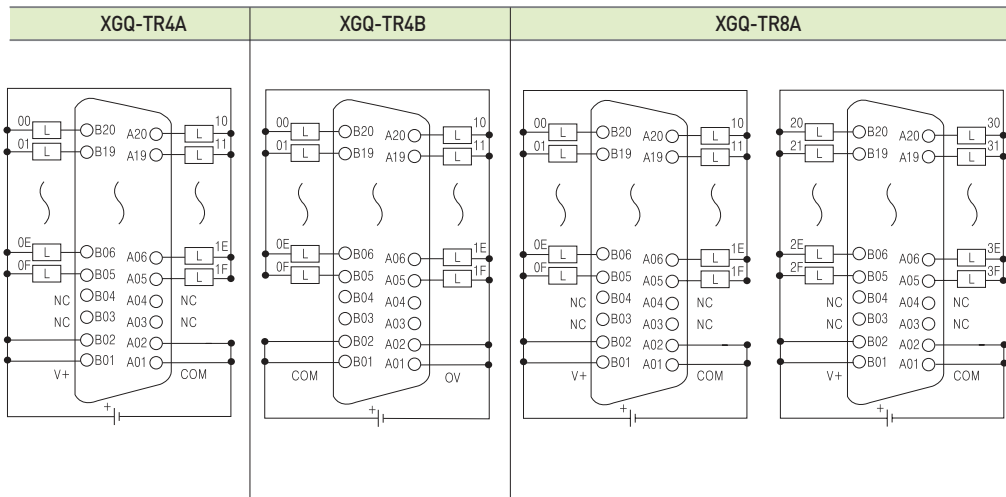
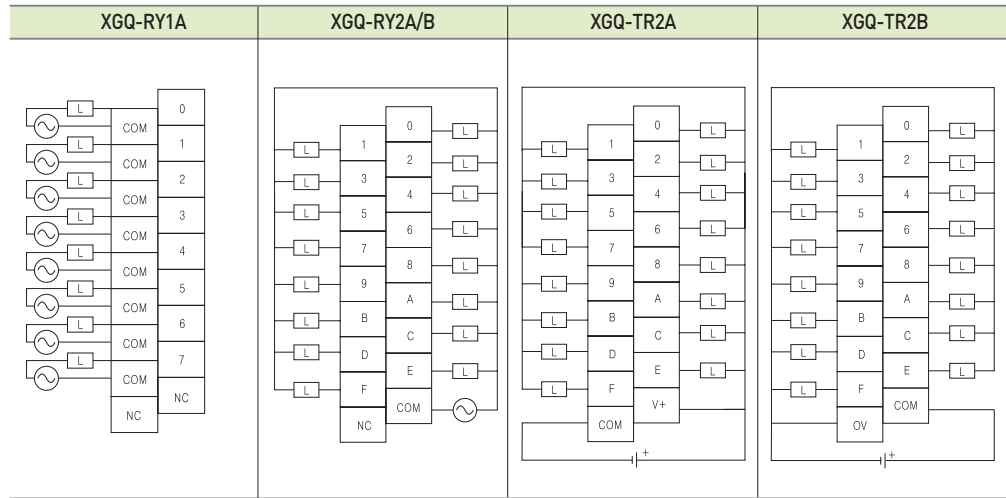



## Diagnostic Digital Input Module(XGI-D21D)

- Diagnostic Digital Input module receives and processes DC 24V input signal. It has a wire break detection function of each input signal.
- Input signal and wire break detection signal are displayed on the device of the CPU module, it can be used in the PLC program.

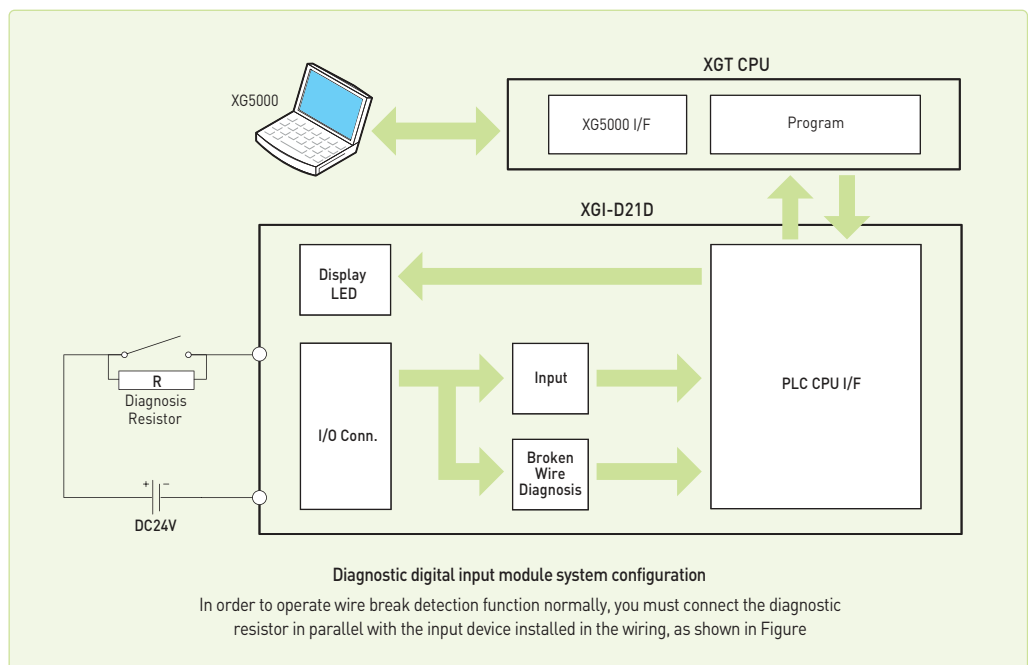

## Specifications

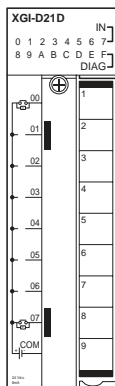

- IN: Input status(0-7)
- On: Input On
  - Off: Input Off
- DIAG: Diagnosis status(8-F)
- On: broken wire occurs
  - Off: Normal state

Item	Specifications
Input point	8 points
Insulation method	Photo coupler insulation
Rated input voltage / current	DC24V / Approx. 8mA
Voltage range	DC20.4~28.8V (5% and lower ripple rate)
On voltage / On current	19V and higher / 5.2mA and higher
Off voltage / On current	11V and lower / 4.7mA and lower
Response time (Input filter)	Off → On: 1ms/3ms/5ms/10ms/20ms/70ms/100ms, Initial value:3ms On → Off: 1ms/3ms/5ms/10ms/20ms/70ms/100ms, Initial value:3ms
Insulation withstand voltage	DC 500V
Insulation resistance	10 <sup>10</sup> Ω and higher by Insulation ohmmeter
Diagnosis function	Wire break detection
Common method	8 point / 1COM
Suitable cable size	Stranded cable between 0.3~0.75mm <sup>2</sup> (2.8mm and smaller outer dia.)
Suitable clamped terminal	R1.25-3 (Sleeve built-in clamped terminal is not available)
Current consumption(mA)	60mA
Operation display	LED On with input On LED On during wire break
External connection method	9 point Terminal strip connector (M3 X 6 screws)
Weight	95g



## Diagnostic Digital Output Module(XGQ-RY1D)

- Diagnostic digital output module outputs output signal via the relay to the outside. It has a diagnostic function of the internal signal and wire break detection for each output signal.
- Diagnostic signals are displayed on the device of the CPU module, it can be used in the PLC program.

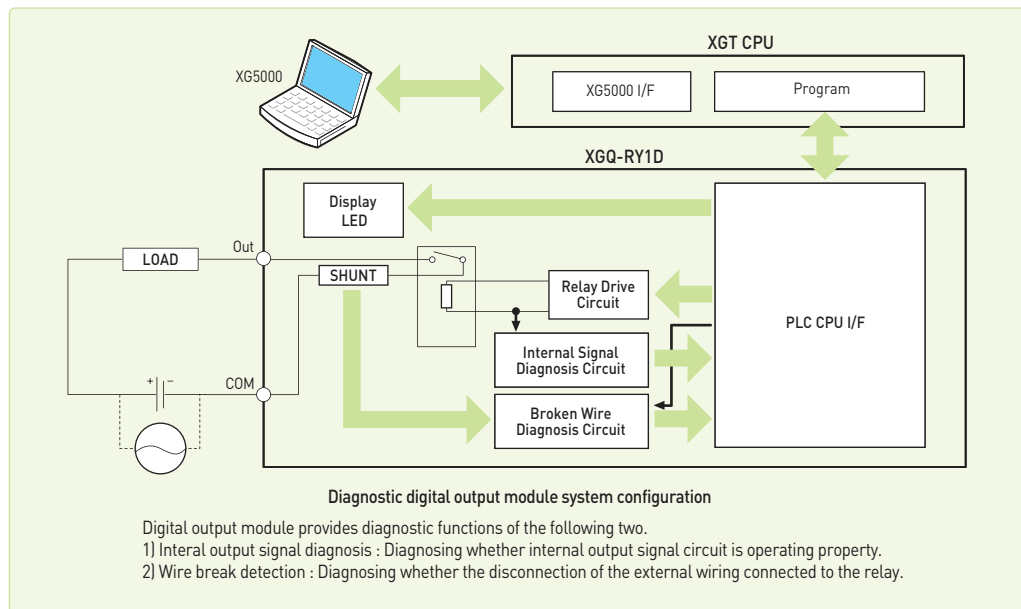

## Specifications

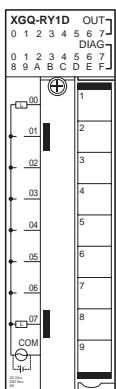

- OUT: Output status (0 ~ 7)**
- On: Relay output On
  - Off: Relay output Off
- DIAG : Diagnosis status**  
Internal output signal diagnosis (0 ~ 7)
- On: Internal output signal fail
  - Off: Normal state
- Wire break detection(8~F)**
- On: broken wire occurs
  - Off: Normal state

Item	Specifications	
Output point	8 points	
Insulation method	Relay insulation Photo coupler insulation	
Rated load voltage	DC24V (resistance load) / AC220V (COS $\phi$ = 1)	
Rated load current	1point: 2A Common: 5A	
Min. load voltage / current	DC5V / 1mA	
Max. load voltage / current	AC250V, DC125V / 2A	
Leakage current at Off	0.1mA (AC220V, 60Hz)	
Max. switching frequency	1,800 times/hour	
Surge killer	None	
Life	Mechanical	20 million and more times
	Electrical	Rated load voltage/current 100 thousand and more times
		AC200V / 1.5A, AC240V / 1A (COS $\phi$ = 0.7) 100 thousand and more times
		AC200V / 1A, AC240V / 0.5A (COS $\phi$ = 0.35) 100 thousand and more times
Response time	DC24V / 1A, DC100V / 0.1A (L / R = 7ms) 100 thousand and more times	
	Off → On: 10ms and lower On → Off: 12ms and lower	
Diagnosis function	Wire break detection Internal output signal diagnosis	
Common method	8 point/1COM	
Current consumption(mA)	Max. 400mA	
Operation display	LED On with output On LED On during wire break LED On when the internal output signal fail	
External connection method	9 point Terminal strip connector (M3 X 6 screws)	
Weight	145g	

### Input/output mixed Type (XGH-DT4A)

Input		Output			
Input points	16 points	Input points	16 points		
Insulation method	Photo coupler	Insulation method	Photo coupler		
Rated input voltage	DC24V	Rated input voltage	DC12/24V		
Rated input current	4mA	Rated input current	DC10.2-26.4V		
Input voltage range	DC20.4-28.8V	Input voltage range	0.1A/point, 1.6A/COM		
Insulation pressure	AC560Vrms / 3Cycle	Insulation pressure	0.1mA or less		
On voltage/current	DC19V or more / 3mA or more	On voltage/current	0.7A/10ms or less		
Off voltage/current	DC11V or more / 1.7mA or more	Off voltage/current	Zener diode		
Input resistance	5.6 $\cdot$	Input resistance	DC 0.2V or less		
Response	Off $\rightarrow$ On	1ms/3ms/5ms/10ms/20ms/70ms/100ms (Setting by CPU parameter)	Response	Off $\rightarrow$ On	1ms or less
		Initial value: 3ms			
	On $\rightarrow$ Off	1ms/3ms/5ms/10ms/20ms/70ms/100ms (Setting by CPU parameter)	On $\rightarrow$ Off	1ms or less (rated load, resistance load)	
		Initial value: 3ms			
Common (COM)	16 points/COM				
Operation display	LED lighting when output is ON				
Internal current consumption	100mA				
External connection	40-point connector				
Weight (kg)	0.1				

### Wiring diagram for mixed type

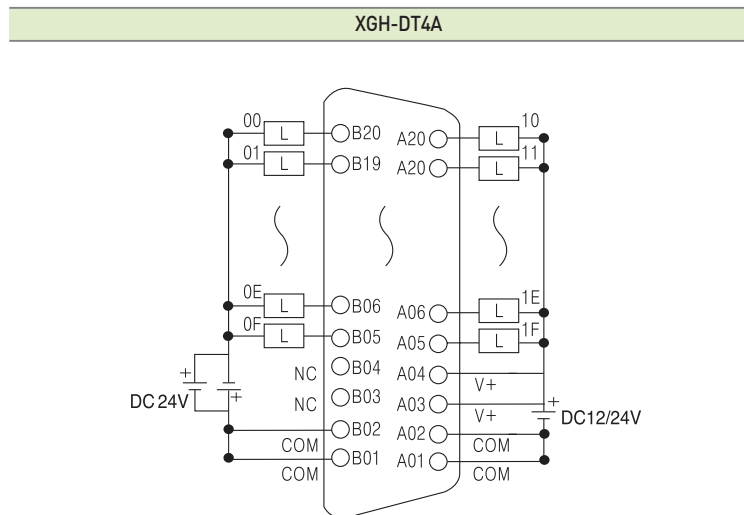

NOTE] Input address for XGK CPU is P00-P0F and Output address is P10-P1F when it is installed on the slot 0.  
 Input address for XGI CPU is %IX0.0.0-%IX0.0.15 and Output address is %QX0.0.16-%QX0.0.31

## Precaution during installation of I/O module

- XGT has 2 kinds of digital input type: Current sink input, Current source input. For DC input module has different wiring depending on the input type, digital input type should be selected with consideration about connected input device.
- Max. number of simultaneous input point differs according to the module type. Therefore, review specification of input module before its application.
- Use an interrupt module when a response of high-speed input is demanded. But only one interrupt module can be installed per CPU module.
- If switching frequency is high or inductive switching load is used, the lifespan of relay output module will be reduced. Therefore, it is recommended to use transistor output module or triac output module.
- When driving an inductive load with output module, set the maximum switching frequency as 'ON' for 1 second and 'OFF' for 1 second.
- When using counter or timer with DC/DC converter, it is possible to have inrush current which cause a break down. Therefore to reduce an effect of inrush current, connect resistor or inductor to load or use the module whose max. load current is high.

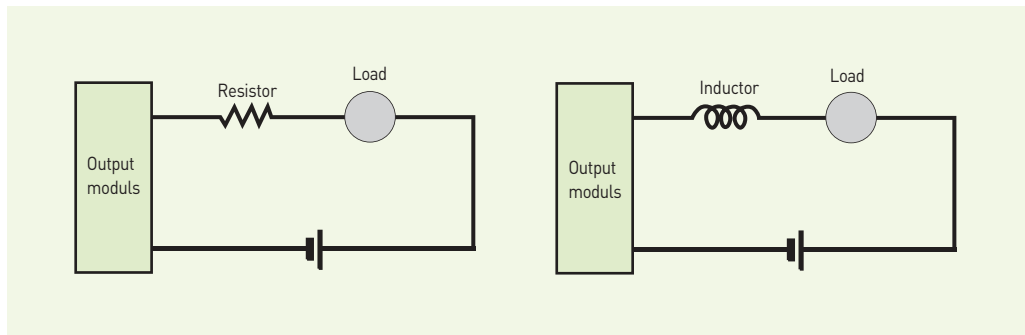

- Fuse of output module is not exchangeable to prevent a damage of external wiring when output module has a short-circuit.
- The number of simultaneous 'ON' points varies depending on input voltage, ambient temperature. Refer to the specification of input module.
- The following graph presents the relay lifespan of relay output module. It shows the maximum lifespan of relay which is used in the relay output.

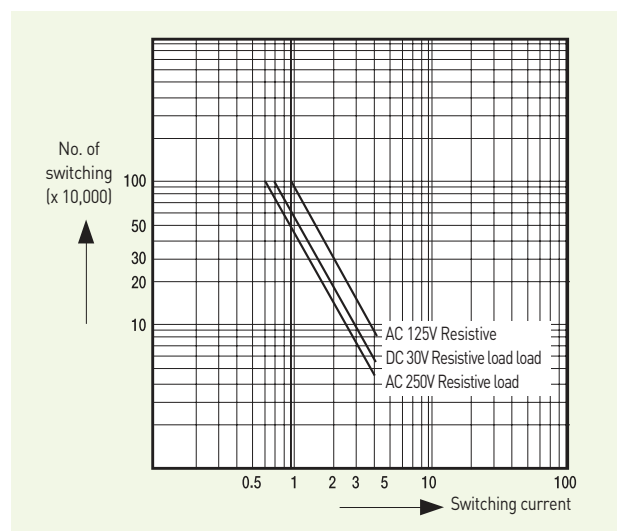

- Compressed terminal attaching sleeve cannot be mounted to XGT terminal block. The following picture shows appropriate compressed terminals for terminal block.

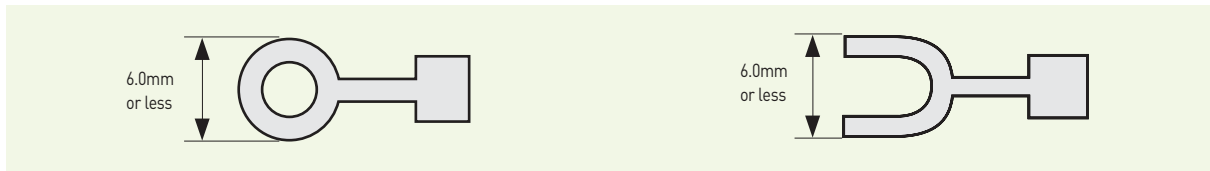

- Use 0.3~0.75mm twisted pair, below 2.8mm thickness cable for connecting to terminal block.
- Be careful when choosing and using the cable since the permissible current differs according to the insulation thickness.
- Joint torque of fixed screw and terminal block screw of the module needs to be within the range in the following table.

Joint	Joint torque range
I/O module terminal block screw (M3)	42-58 N-cm
I/O module terminal block fixed screw (M3)	68-89 N-cm

- Thermal protector is built in transistor module. Thermal protector is a function that protects PLC from an overload and overheating.









# XGR Redundancy System

## Redundancy system for high-speed process control based on IEC

- Processing speed: 42ns/step
- I/O Points: Max. 131,072
- Total memory: 25MB (Program 7MB, Data 2MB, Flash 16MB)
- Switching over time: Min 4.3ms, Max 22ms
- Built-in 256 PID loops control

Contents	34	XGR Configuration
	36	System configuration
	38	XGR-INC Configuration
	40	System configuration
	42	Application



## XGR Configuration

- Base, Power, CPU, Network redundancy
- Dual port and 3 kinds of media (Twisted-Twisted, Optic-Optic, Twisted-Optic)

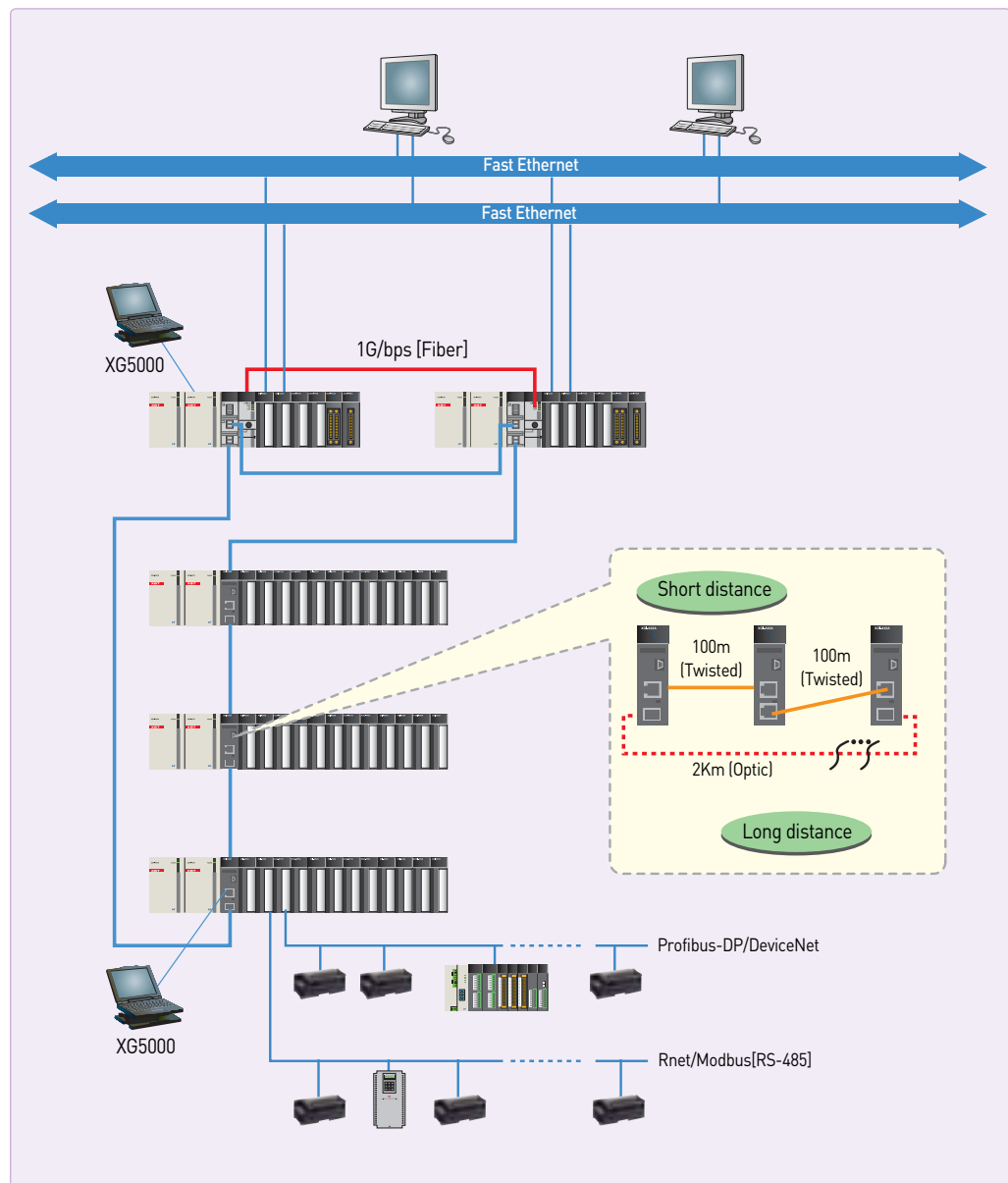

## System configuration method

### Fiber-optic

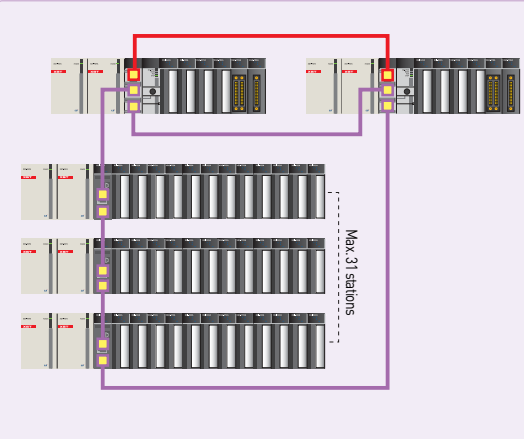



**XGR-CPUH/F**

- Main CPU
- Fiber optic: Max. distance 2Km



**XGR-DBDF**

- Expansion drive module
- Fiber optic: Max. distance 2Km (Installed on the expansion base)
- Max. 31 stations

### Twisted pair

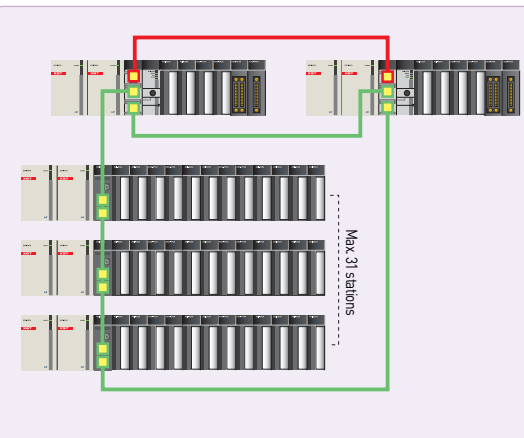



**XGR-CPUH/T**

- Main CPU
- Twisted pair: Max. distance 100m



**XGR-DBDT**

- Expansion drive module
- Twisted pair : Max. distance 100m (Installed on the expansion base)
- Max. 31 stations

### Hybrid ( Twisted pair + Fiber Optic )

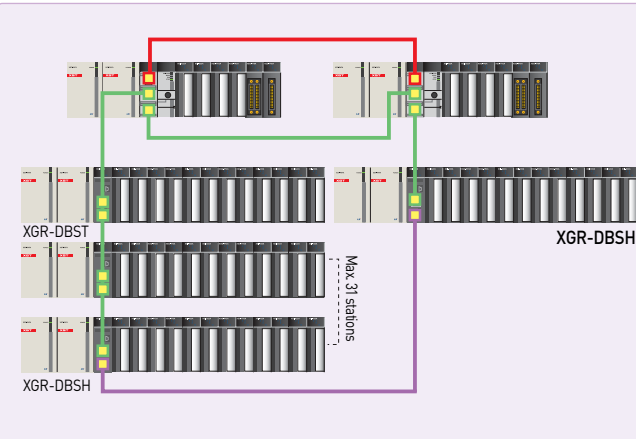



**XGR-CPUH/T XGR-CPUH/F**

- Main CPU
- Fiber optic: Max. distance 2Km
- Twisted pair: Max. distance 100m



**XGR-DBSH**

- Expansion drive module
- Fiber optic: Max. distance 2Km
- Twisted pair: Max. distance 100m (Installed on the expansion base)
- Max. 31 stations

\* Max. expandable distance: Fiber optic 60km, Twisted pair 3km

\* CPU synchronization cable: 2m, 5m

SYSTEM

## System configuration

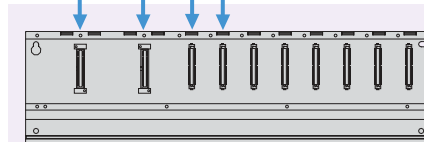
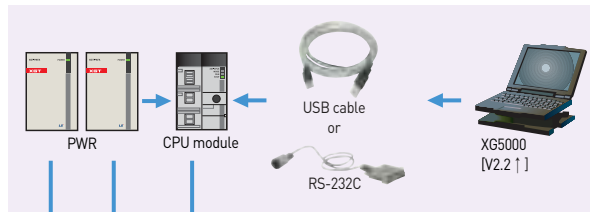

Main base [A Side] XGR-M06P / XGR-M02P

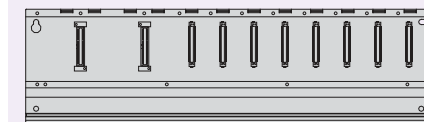

Main base [B Side] XGR-M06P / XGR-M02P

### Main base

- 2 types of CPU (Fiber optic, Twisted fair)
- Power: AC110V, AC220V
- 6slot base: enable to install 6 communication modules

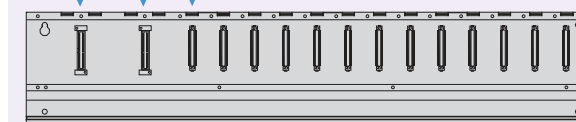
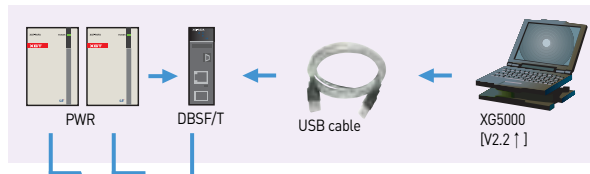

Expansion base XGR-E12P / XGR-E12H

### Expansion base

- Power: 8.5A/AC110V, 8.5A/AC220V
- Expansion drive: Fiber optic, Twisted fair, Hybrid
- EFM\* and EIM\*: not available with 12slot base

XGR module		
CPU	XGR-CPUH/T	Twisted pair
	XGR-CPUH/F	Fiber optic(2km)
	XGR-CPUH/S	Fiber optic(15km)
Power	XGR-AC12	110V, 5.5A(Main base)
	XGR-AC13	110V, 8.5A(Expansion base)
	XGR-AC22	220V, 5.5A(Main base)
	XGR-AC23	220V, 8.5A(Expansion base)
Base	XGR-DC42	DC24V/DC5V 7A, Main(Expansion base)
	XGR-M02P	2Slot(Main base)
	XGR-M06P	6Slot(Main base)
	XGR-E08P	8Slot(Expansion base)
	XGR-E12P	12Slot(Expansion base)
Expansion drive	XGR-E12H	12Slot(Expansion base, Drive Redundancy)
	XGR-DBST	Twisted pair - Twisted
	XGR-DBSF	Pair Fiber optic - Fiber optic(2km)
	XGR-DBSH	Twisted pair - Fiber optic(2km)
	XGR-DBSFS	Pair Fiber optic - Fiber optic(15km)
	XGR-DBSHS	Twisted pair - Fiber optic(15km)

XGR module		
Expansion drive redundancy	XGR-DBDT	Twisted pair - Twisted
	XGR-DBDF	Pair Fiber optic - Fiber optic(2km)
	XGR-DBDH	Twisted pair - Fiber optic(2km)
Sync & Expansion cable	XGC-F201	2m (Fiber optic)
	XGC-F501	5m (Fiber optic)

Item	Input module		
	AC110V	AC220V	DC24V
8 points	-	XGI-A21A, XGI-A21C	XGI-D21A
16 points	XGI-A12A	-	XGI-D22A
	-	-	XGI-D22B
32 points	-	-	XGI-D24A
	-	-	XGI-D24B
64 points	-	-	XGI-D28A
	-	-	XGI-D28B

Item	Output module		
	Relay	Triac	Transistor
8 points	XGQ-RY1A	-	-
16 points	XGQ-RY2A	XGQ-SS2A	XGQ-TR2A
	XGQ-RY2B	-	XGQ-TR2B
32 points	-	-	XGQ-TR4A
	-	-	XGQ-TR4B
64 points	-	-	XGQ-TR8A
	-	-	XGQ-TR8B

Item	Input/Output mixed module	
	16-point DC input	16-point TR output

Special module		
Analog input	XGF-AV8A	Voltage input type, 8Ch
	XGF-AC8A	Current input type, 8Ch
	XGF-AD8A	Voltage/ Current input, 8Ch
	XGF-AD4S	Voltage/ Current input, 4Ch (Isolated)
Analog output	XGF-AD16A	Voltage/ Current input, 16Ch
	XGF-AW4S	2-wire, Voltage/ Current input, 4Ch (Isolated)
	XGF-DV4A	Voltage output type, 4Ch
	XGF-DC4A	Current output type, 4Ch
	XGF-DV8A	Voltage output type, 8Ch
	XGF-DC8A	Current output type, 8Ch
	XGF-DV4S	Voltage output, 4Ch (Isolated)
	XGF-DC4S	Current output, 4Ch (Isolated)
Analog Input/Output	XGF-AH6A	Input: 4ch, Voltage/ Current Output: 2Ch Voltage/ Current
High-speed counter	XGF-HO2A	Pulse (OC) input type, 2Ch
	XGF-HD2A	Pulse (LD) input type, 2Ch
Positioning	XGF-PD1A-PD3A	Open collector, 1-3axis
	XGF-PD1H-PD3H	Line drive, 1-3axis
	XGF-PD1H-PD4H	Open collector, 1-4axis
Positioning (Network Type)	XGF-PN8A	LS Standard EtherCAT Net. 8axis
	XGF-PN8B	Standard EtherCAT Net. 8axis
	XGF-M32E	Standard EtherCAT Net. 32axis
Temperature control	XGF-TC4S	Thermocouple input, 4Ch
	XGF-RD4A	RTD input, 4Ch
	XGF-RD4S	RTD input, 4Ch (Insulated)
	Temperature controller	XGF-TC4UD
XGF-TC4RT		Input: 4ch.(RTD) Output: 4ch.(TR) Controller: 4 loops
XGF-S0EA		DC24V, 32points

Communication module		
RAPIEnet	XGL-EIMT	RAPIEnet Twisted fair 2Ch
	XGL-EIMH	RAPIEnet Fiber optic/Twisted fair 1Ch
	XGL-EIMF	RAPIEnet Fiber optic 2Ch
	XGL-ES4T	RAPIEnet Switch. 4Ports
Cnet	XOL-EIMT	RAPIEnet Twisted fair 2Ch For PC
	XOL-EIMF	RAPIEnet Fiber optic 2Ch For PC
	XGL-CH2B	RS-232C/RS-422
Ethernet (Open)	XGL-C22B	RS-232C, 2Ch
	XGL-C42B	RS-422, 2Ch
	XGL-EFMTB	Fiber optic, Master, SC type
Ethernet (Dedicated)	XGL-EFMFB	Twisted pair, Master, RJ-45
	XGL-EHST	Fast Ethernet, Switching hub
EtherNet/IP	XGL-EDMF	Fiber optic, Master, SC type
	XGL-EDMT	Twisted pair, Master, RJ-45
Rnet	XGL-EIPT	Industrial Ethernet, 2ports
DeviceNet	XGL-RMEB	Rnet, Master, TP
	XGL-DMEB	DeviceNet, Master
Profibus-DP	XGL-PMEB	Profibus-DP, Master
	XGL-PSRA	Profibus-DP Slave, Remote interface
	XGL-PSEA	Profibus-DP Slave
Fnet	XGL-FMEA	Dedicated network
BACnet/IP	XGL-BIPT	BACnet client/server

## Specification

Item		Description		Remark
		XGR-CPUH/F	XGR-CPUH/T	
Media		Fiber optic	Twisted pair	
Operation method		Cyclic execution, Periodic operation, Interrupt operation, Fixed scan		
I/O control method		Scan synchronized batch processing method (Refresh method)		
Program language		LD (Ladder Diagram), ST (Structured Text), SFC (Sequential Function Chart), IL (Read only)		
Number of Instructions	Operator	18		
	Standard function	130 + Real type function		
	Standard function block	41		
Special function/ function block		Special function block, Process control function block		
Processing speed	LD	0.042 $\mu$ s/Step		
	MOV	0.126 $\mu$ s/Step		
	Real type	$\pm$ : 0.602 $\mu$ s(S), 1.078 $\mu$ s(D) x : 1.106 $\mu$ s(S), 2.394 $\mu$ s(D) $\div$ : 1.134 $\mu$ s(S), 2.66 $\mu$ s(D)		S : Real type D : Long real type
I/O points		I: 131,072 points, Q: 131,072 points (Total: 1131,072)		
DRAM	Program memory	7MB		Including Upload, Parameter, System area *Battery back-up memory : 8MB
	Data memory	2MB		
	Reserved memory	7MB		
Flash memory		16MB		
Data memory	Direct variable	256k Byte		
	Auto allocated variable	512k Byte		
	Timer	No limitation, Range: 0.001sec ~ 4,259,967.295sec (1,193hours)		
	Counter	No limitation, Range: -32,768 ~ +32,767		
	Flag	System	4k Byte	
Communication		64k Byte		L, N area
Special		2k Byte (32 base, 16 slot, 32 channel )		U area : Analog device area
File register		64k Byte *2		R area : read/write (Command, XG5000)
Program	Number of program blocks	256		
	Initial task	1 (_INT)		
	Cycle task	32		
	Internal device task	32		
Operation mode		RUN, STOP, DEBUG		
Restart mode		Warm, Cold		
Self diagnostic functions		Watchdog timer, Memory error, I/O error, Battery error, Power Supply error		
Program download		RS-232C (1CH), USB (1CH)		
Data retain		Auto allocated variable: set by variable definition Direct variable: set by parameter		
Max. expansion base		31 stages		

## Specification

Item	Hardware	Remark
CPU module	2 slot / Fiber, Twisted fair	
Expansion drive module	1 slot / Fiber, Twisted fair, Hybrid	
Base	Main base: 6 slot, Expansion base: 12 slot	
Power	AC110V	5V-5.5A
	AC220V	5V-5.5A
	AC110V	5V-8.5A
	AC220V	5V-8.5A
Expansion method and Max. expansion base	31 stages by network	
Base number setting	Rotary switch of expansion drive module	
Distance between expansion bases	Twisted fair: 100m (3km), Fiber: 2km (60km)	
Master/Standby switching over time	50ms or less	

## Available modules for each base

	Base	Available modules
1	Main base	CPU, Ethernet module (XGL-EFMx), RAPIenet module (XGL-EIMx) * x: T (Twisted fair), F (Fiber optic), H (Hybrid)
2	Expansion base	I/O modules for XGI (Ethernet based communication module should be installed on Main base Number of communication module: 12 for High-speed link, 8 for P2P Number of analog module: Analog input (139), Analog output (250)

## XGR-INC (Intelligent Network Controller)



### High performance

#### Premium CPU for high performance and high reliability

- CPU processing speed: 42ns/step
- 32 Bit Micro Processor
- Redundancy system and CPU synchronization by optical cable
- Program memory: 7MB ( included program, upload, parameter and system areas)
- Data memory: 2MB, Flash memory: 16MB
- Master switching over time: min 4.3ms ~ max 22ms

### Intelligent

#### Open network- international standard communication

#### Easy to connect from upper information system to field devices

- Easy expansion installation using network cable - Fiber optic and twisted pair
- Ring Topology for redundancy expansion cable
- Max. 3 expansion base Distance: Fiber 2km (Max. expansion 4km), Twisted pair 100m (Max. expansion 200m)
- Program upload and download via expansion base.
- Ethernet network: XGT, Modbus TCP, Ethernet/IP protocol
- Ethernet Ring Topology: RAPIenet
- Serial network: RS-232C/422/485, XGT, Modbus RTU/ASCII
- Fieldbus network: Profibus-DP, DeviceNet

### Easy

#### Component compatibility with XGT PLC Easy to program using XG5000

- Except CPU, XGR series have compatibility with XGT series-base, power, digital I/O, communication and so on.\*
- IEC 61131-3 Convenient setup for communication and network parameter
- Easy to set heterogeneous protocol using customer communication setting
- Easy to set Profibus-DP, DeviceNet, Rnet and Ethernet using high speed link communication setting
- Variety monitoring means: frame monitor, communication status monitor, communication status flag and so on.

\* Analog I/O and special module are not available.

### XGR-INC configuration

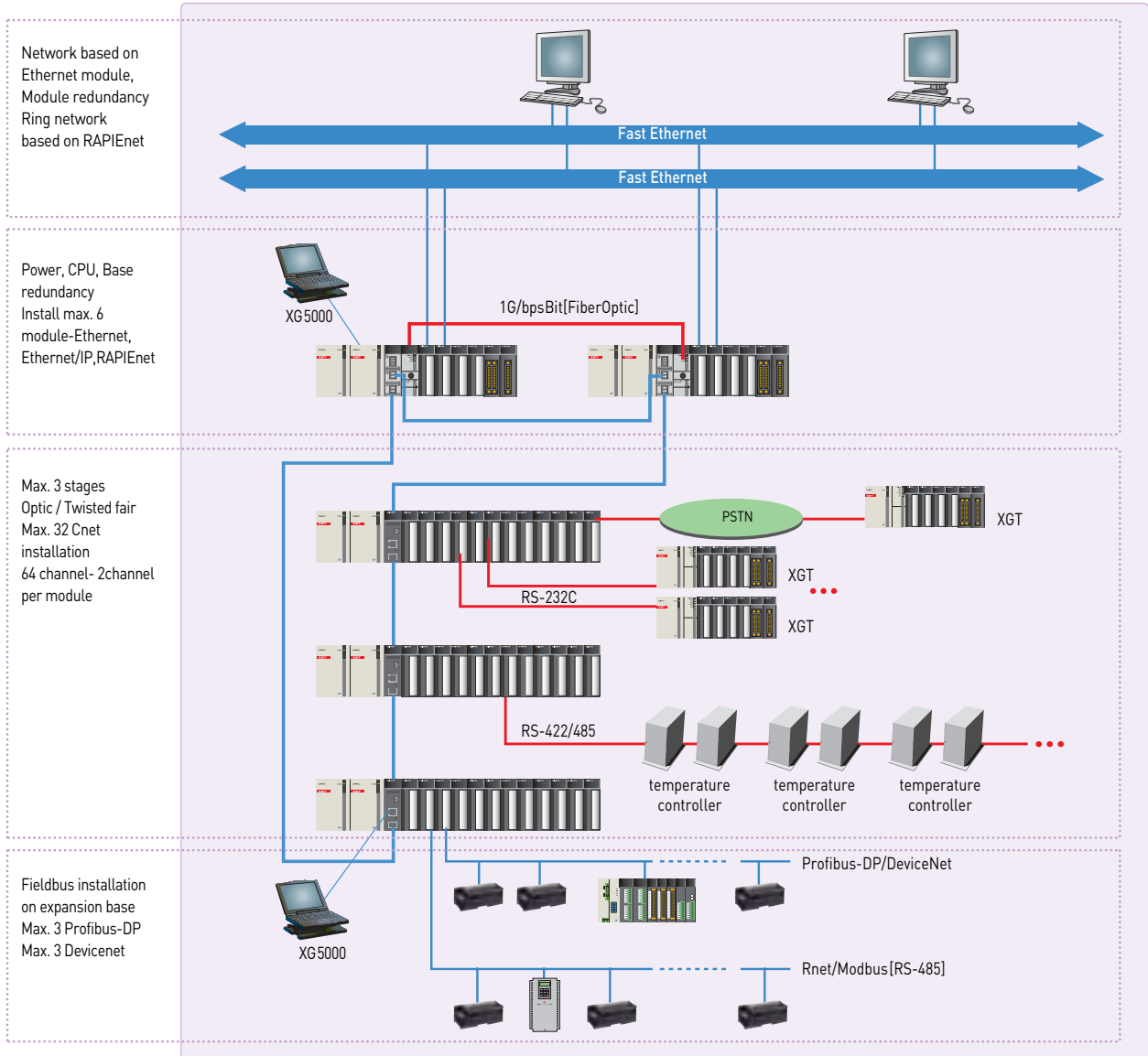

\* PSTN: Public Switched Telephone Network.

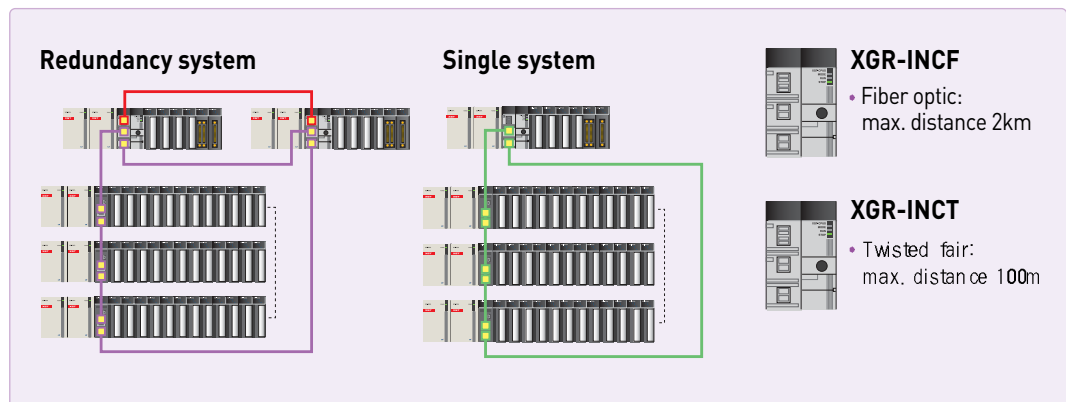

SYSTEM

## XGT System configuration

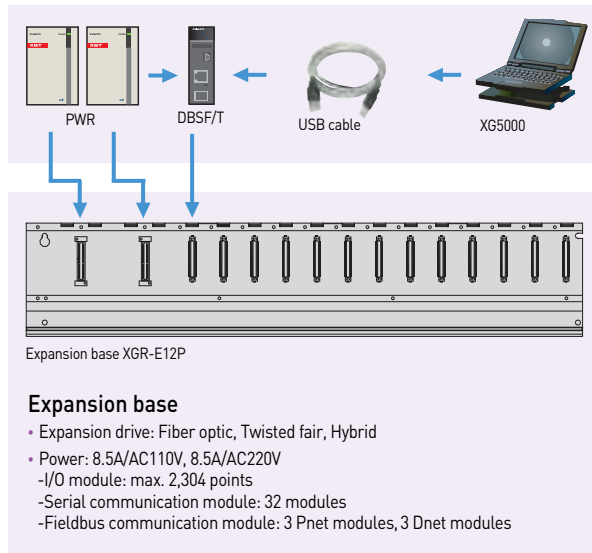
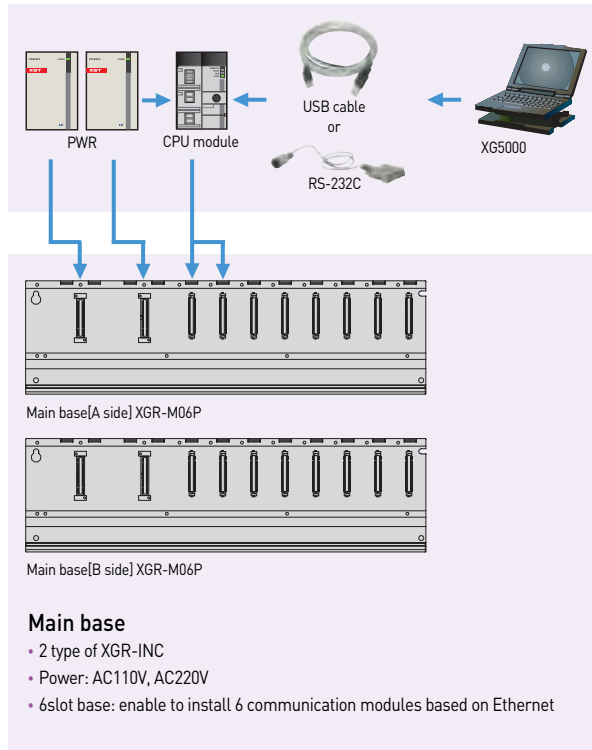

Base module	
USB-301A	USB download cable
K1C-050A	RS-232C download cable
XGC-F201	Optic, 2m, Redundancy CPU synchronization cable
XGC-F501	Optic, 5m, Redundancy CPU synchronization cable

Power module	
XGR-AC12	110V/DC5V 5.5A, base/expansion
XGR-AC13	110V/DC5V 8.5A, expansion
XGR-AC22	220V/DC5V 5.5A, base/expansion
XGR-AC23	220V/DC5V 8.5A, expansion
XGR-DC42	DC24V/DC5V 7A, base/expansion

Expansion drive	
XGR-DBST	Twisted fair 2Ch
XGR-DBSF	Fiber optic 2Ch
XGR-DBSH	Twisted fair 1Ch and Fiber optic 1Ch

Item	Input module		
	AC110V	AC220V	DC24V
8points	-	XGI-A21A	XGI-D21A
16points	XGI-A12A	-	XGI-D22A
	-	-	XGI-D22B
32points	-	-	XGI-D24A
	-	-	XGI-D24B
64points	-	-	XGI-D28A
	-	-	XGI-D28B

Item	Output module		
	Relay	Triac	Transistor
8points	XGQ-RY1A	-	-
16points	XGQ-RY2A	XGO-SS2A	XGQ-TR2A
	XGQ-RY2B	-	XGQ-TR2B
32points	-	-	XGQ-TR4A
	-	-	XGQ-TR4B
64points	-	-	XGQ-TR8A
	-	-	XGQ-TR8B

Item	Communication module	
RAPIEnet	XGL-EIMT	RAPIEnet, Twisted fair 2Ch
	XGL-EIMT	RAPIEnet, Fiber optic 2Ch
	XGL-EIMH	RAPIEnet, Twisted fair, Fiber optic
	XGL-ES4T	RAPIEnet Switch, 4Ports
	XOL-EIMT	RAPIEnet, Twisted fair 2Ch for PC
FEnet	XOL-EIMF	RAPIEnet, Fiber optic 2Ch for PC
	XGL-EFMTB	Open Ethernet, Twisted fair
	XGL-EFMFB	Open Ethernet, Fiber optic
FDEnet	XGL-EH5T	Open Ethernet, Twisted fair 5Ch, Switching HUB
	XGL-EDMT	Dedicated Ethernet, Twisted fair
Ethernet/IP	XGL-EDMF	Dedicated Ethernet, Fiber optic
	XGL-EIPT	Industrial Ethernet, Twisted fair 2Ch
Cnet	XGL-CH2B	RS-232C, RS-422/485
	XGL-C22B	RS-232C 2Ch
	XGL-C42B	RS-422/485 2Ch
Dnet	XGL-DMEB	DeviceNet, Master
Pnet	XGL-PMEB	Profibus-DP, Master
Rnet	XGL-RMEB	Rnet, Master
BACnet/IP	XGL-BIPT	BACnet client/server



## Specification

Item		XGR-INCT	XGR-INCF	Remark	
Operation method		Cyclic execution, Fixed scan			
I/O control method		Scan synchronized batch processing method (Refresh method)			
Program language		Ladder Diagram, Sequential Function Chart, Structured Text			
Number of Instruction	Operator	18			
	Standard function	136 + Real type function			
	Standard function block	43			
Processing speed	LD	0.042ms/step			
	MOV	0.112ms/step			
	Real type	+, -.0.602ms(S), 1.078ms(D) *: 1.106ms(S), 2.394ms(D), /: 1.134ms(S), 2.660ms(D)		S: Real type (32bits) D: Long real type (64bits)	
Program memory		7MB (included upload, parameter, system areas)			
I/O points		2,304 points			
Number of module installation	Ethernet	Ethernet, RAPIenet, Ethernet/IP Installation on base (max. 6modules)			
	Serial	Installation on expansion (max. 32 modules, 64Ch)		Serial and Field modules can be installed maximum 32 on expansion.	
	Fieldbus	Installation on expansion, Profibus-DP (max. 3 modules), DeviceNet (max. 3 modules)			
Data memory	Auto allocated variable (A)		512k Byte		
	Input variable(I)		16k Byte		
	Output variable(Q)		16k Byte		
	Direct variable	M	256k Byte(max. 128k Byte in blackout)		
		R	64k Byte * 2		
W		128k Byte			
Timer		No limitation in auto allocated variable area			
Counter		No limitation in auto allocated variable area			
Program	Scan program		256		
	Initial task		1 ( _INT)		
	Cycle task		32		
	Internal device task		32		
Operation mode		Run, Stop, Debug			
Restart mode		Warm, cold			
Self diagnostic functions		Watchdog timer, Memory error, I/O error, Battery error, Power Supply error			
Program download		RS-232C (1Ch), USB (1Ch)		Remote connection using Ethernet	
Data retain		Auto allocated variable: set by variable definition Direct variable: set by parameter			
Max. expansion base		3 stages			
Distance between expansion bases		920mA	1,310mA		
Current consumption		260g	280g		
Maximum distance between the base expansion		100m	2Km		

## Water power generation or Dam door control

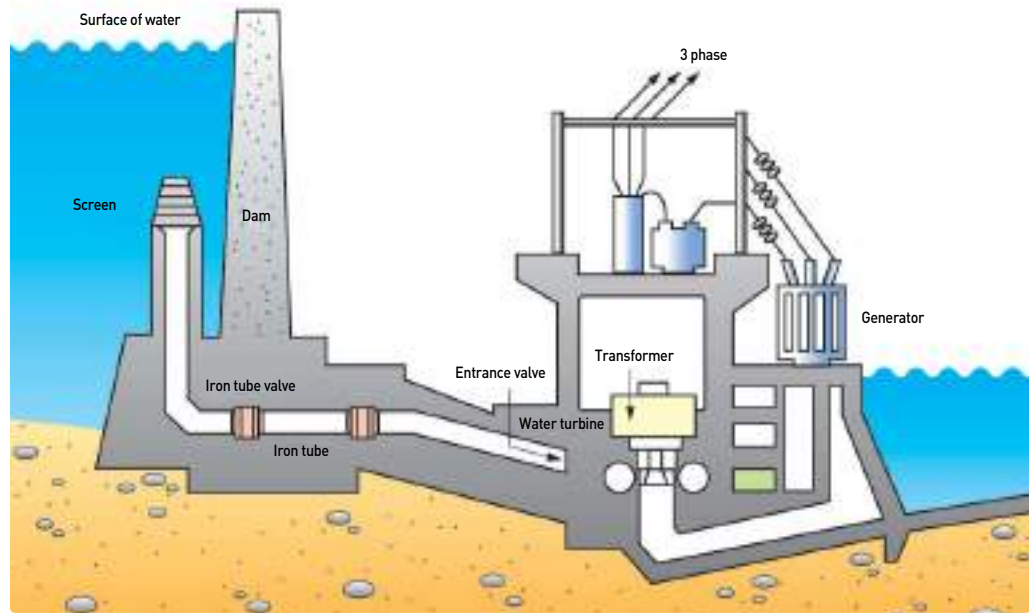

## System configuration

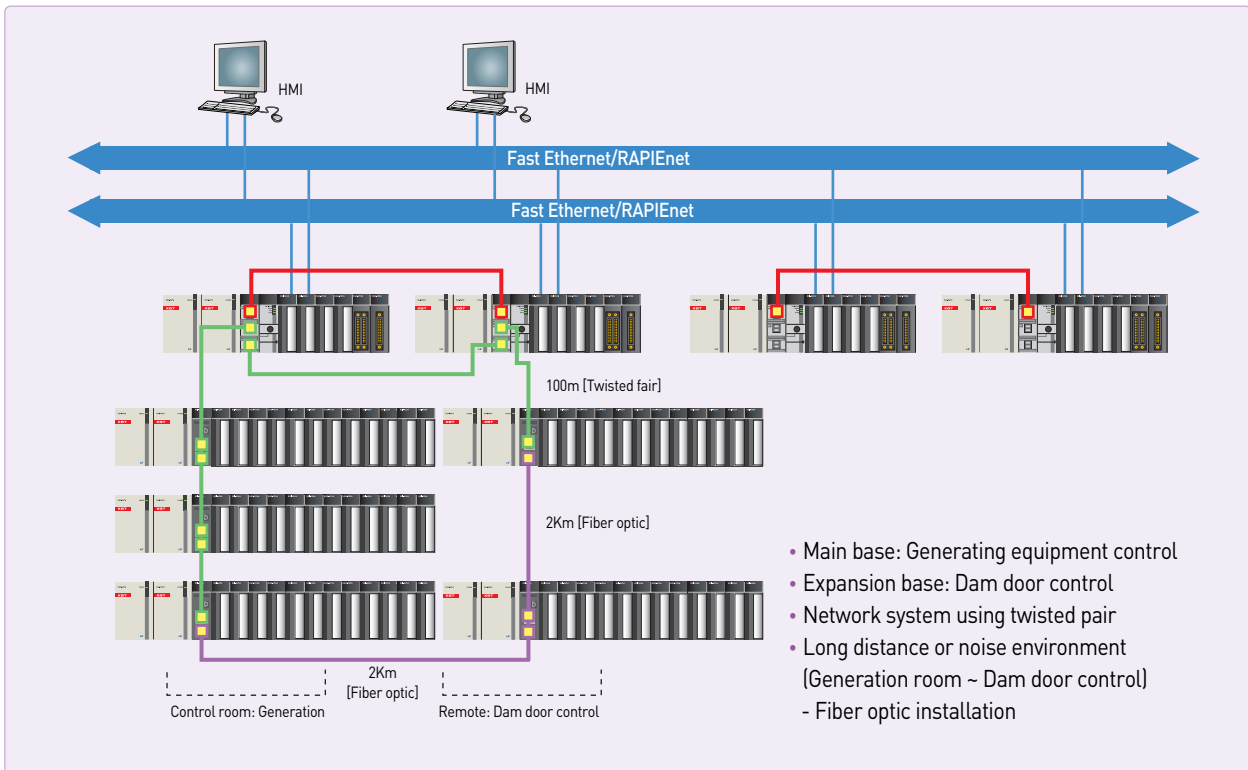

## Generating boiler control

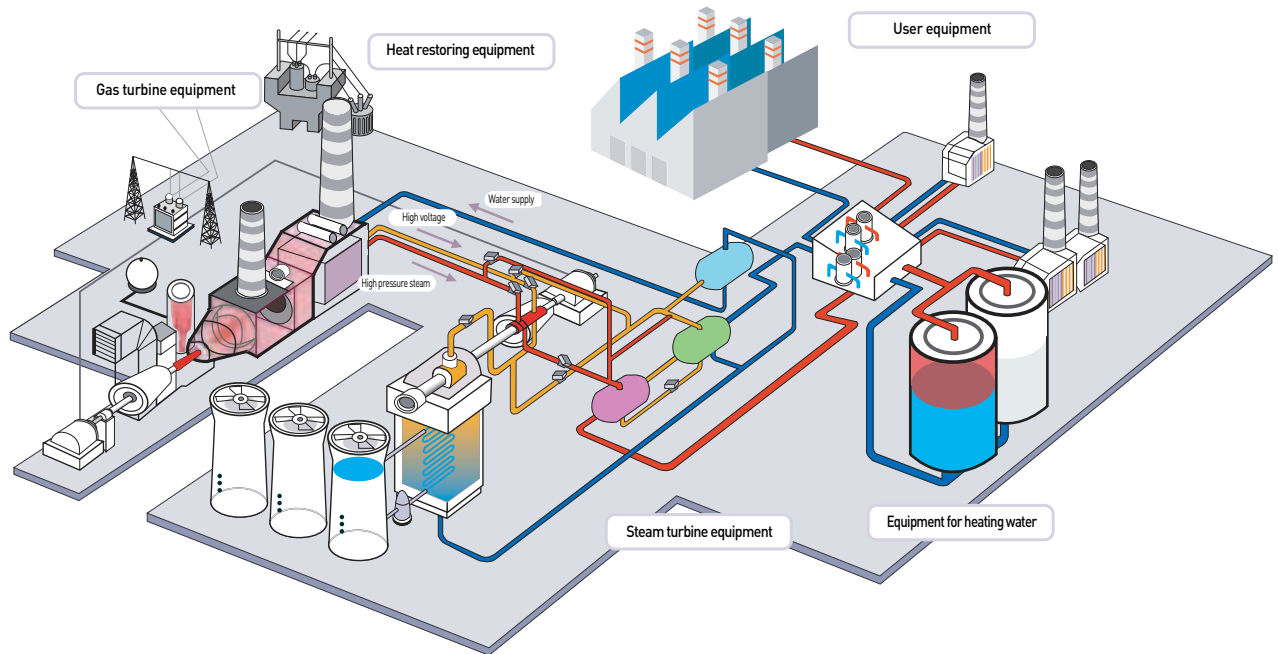

SYSTEM

## System configuration

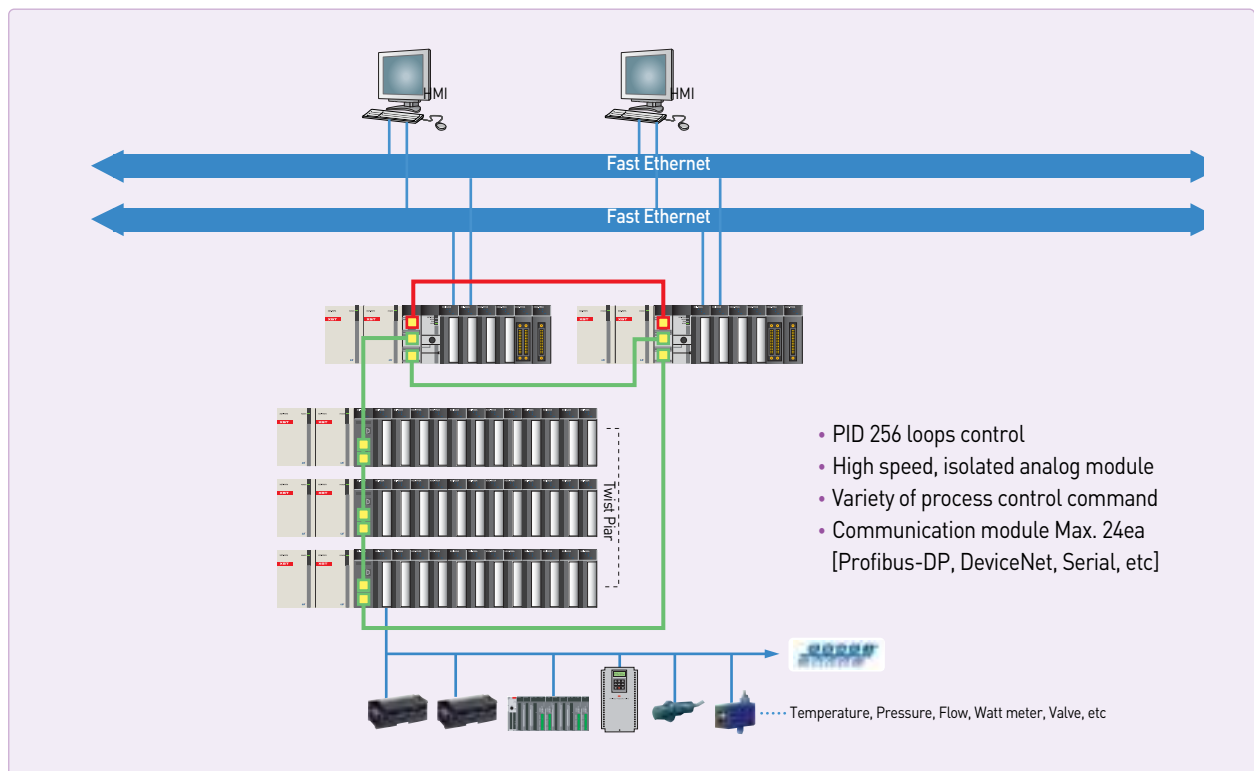

## Stage control

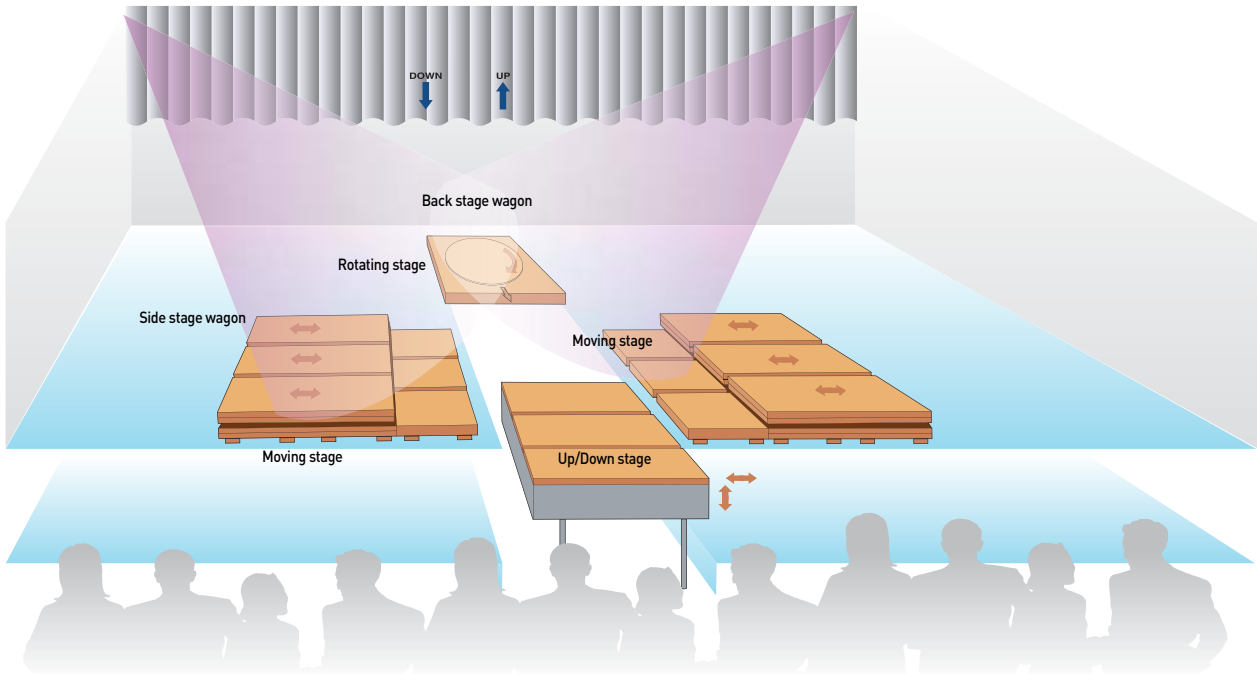

## System configuration

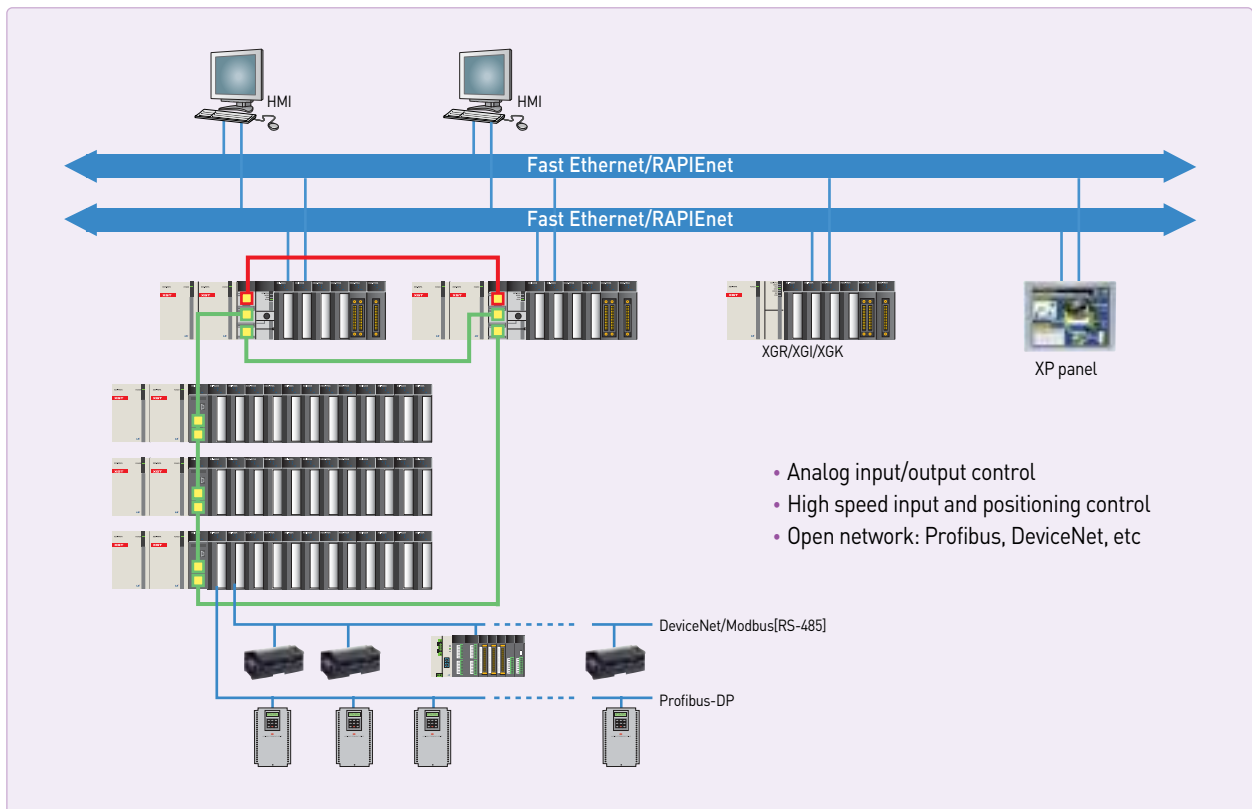

## Water processing control

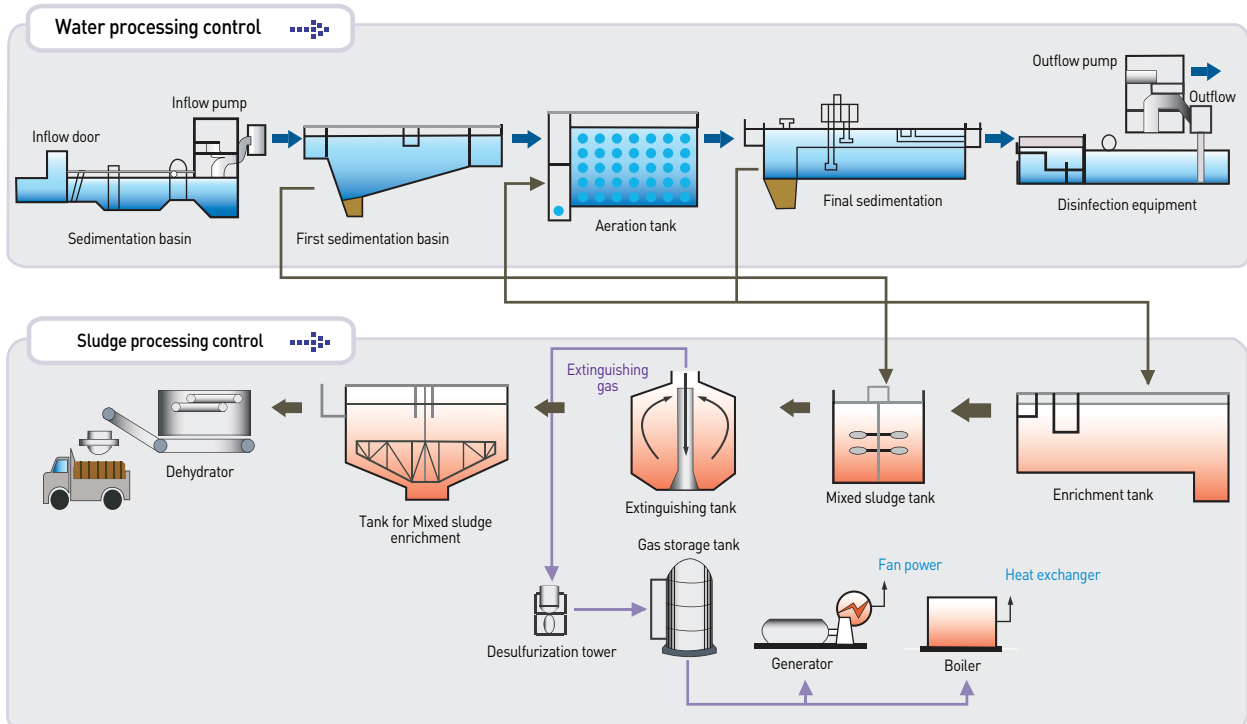

SYSTEM

## System configuration

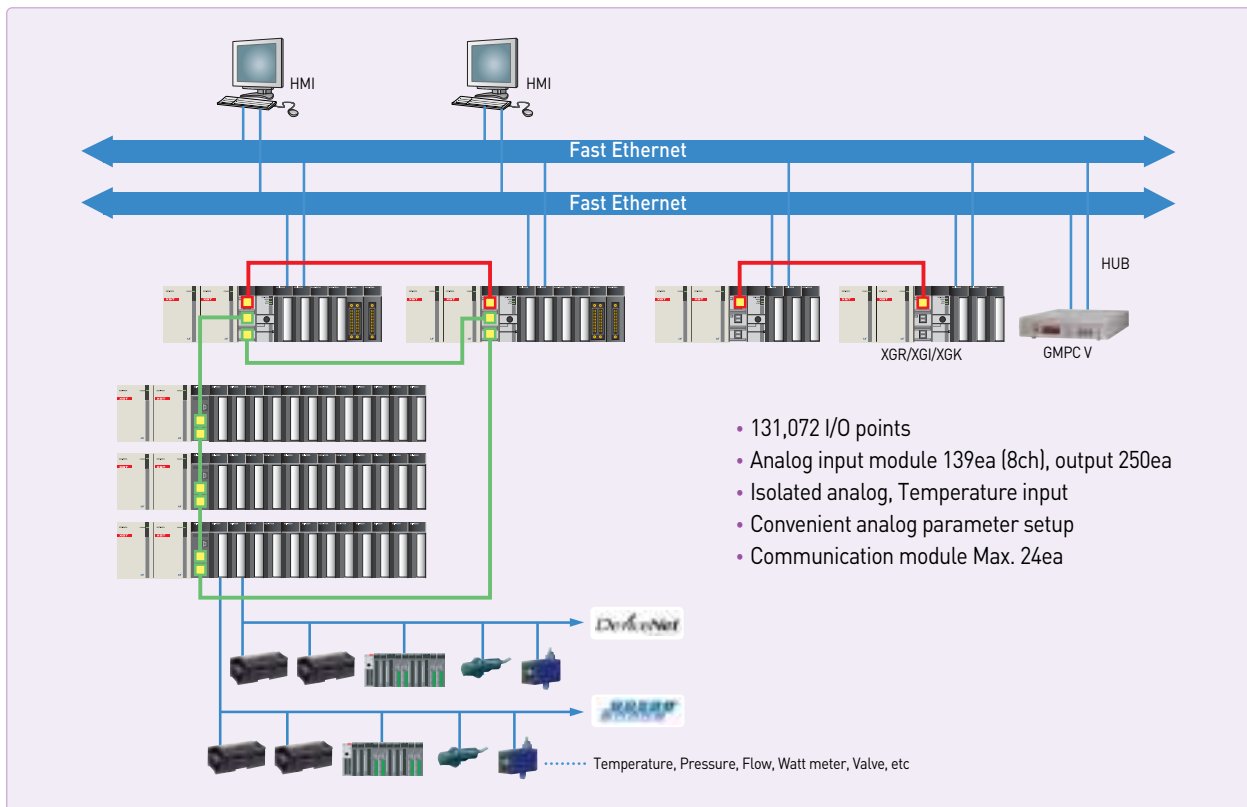

## Incinerator control

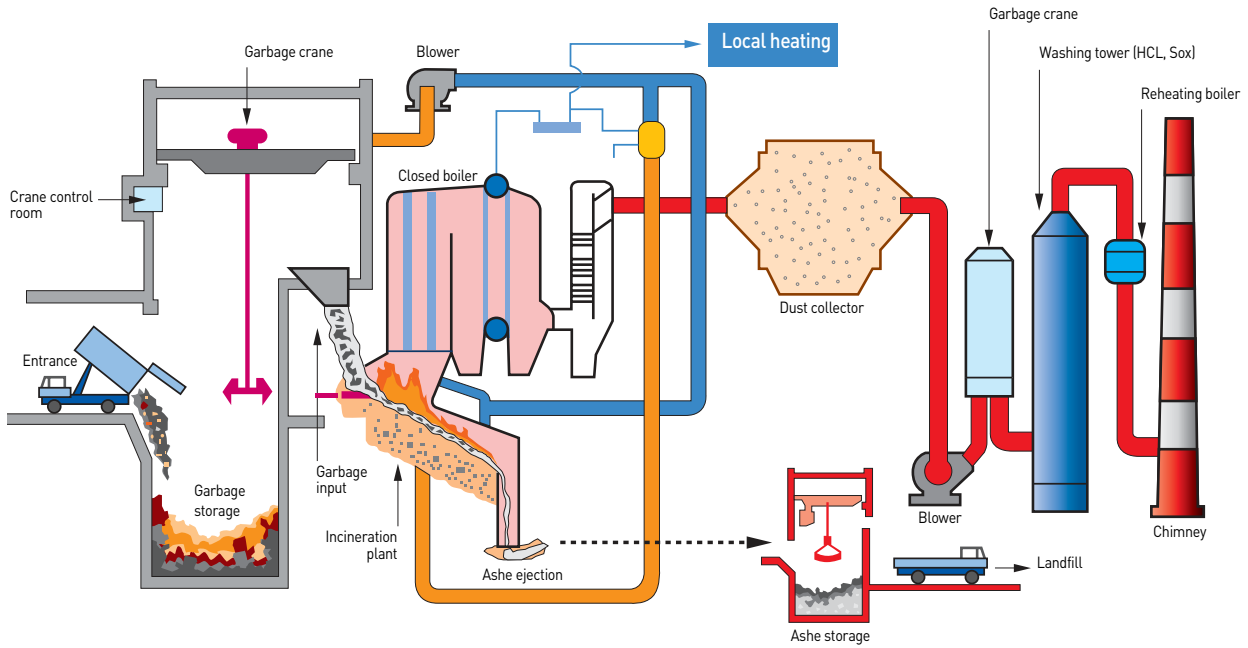

## System configuration

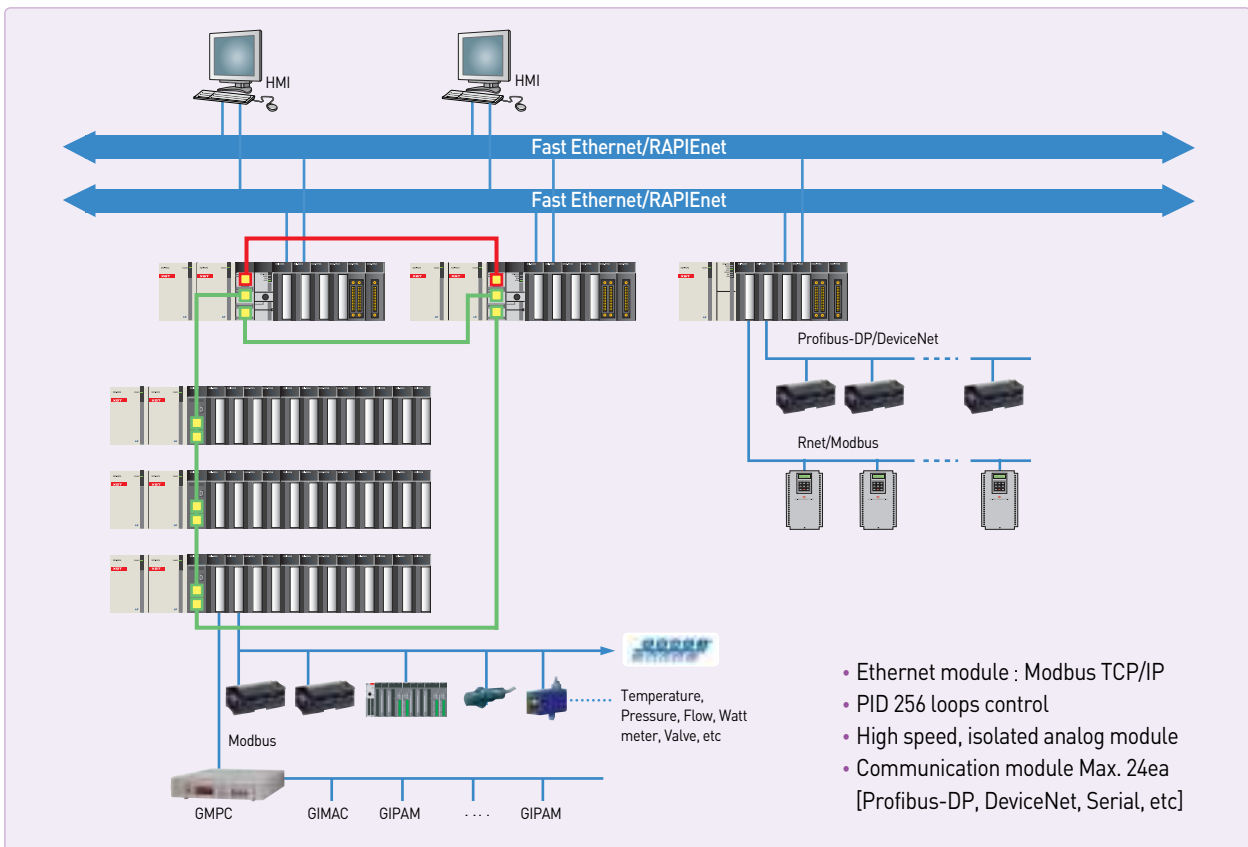

### Broad casting system

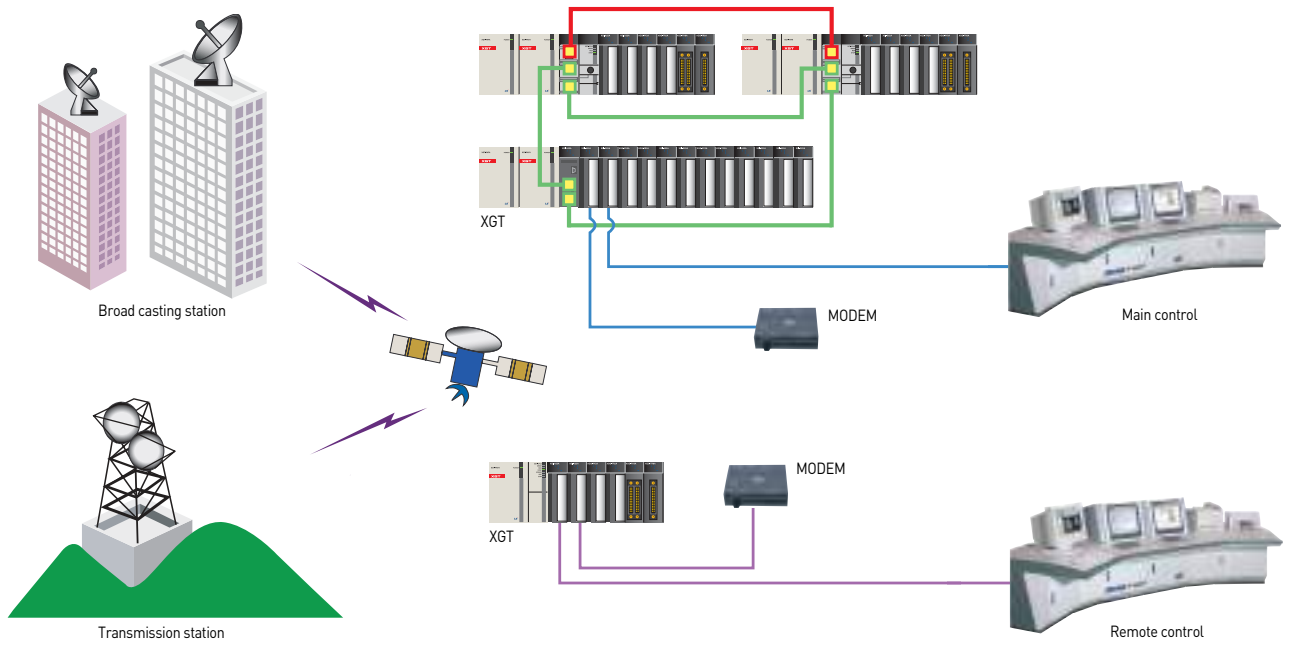

SYSTEM

### System configuration

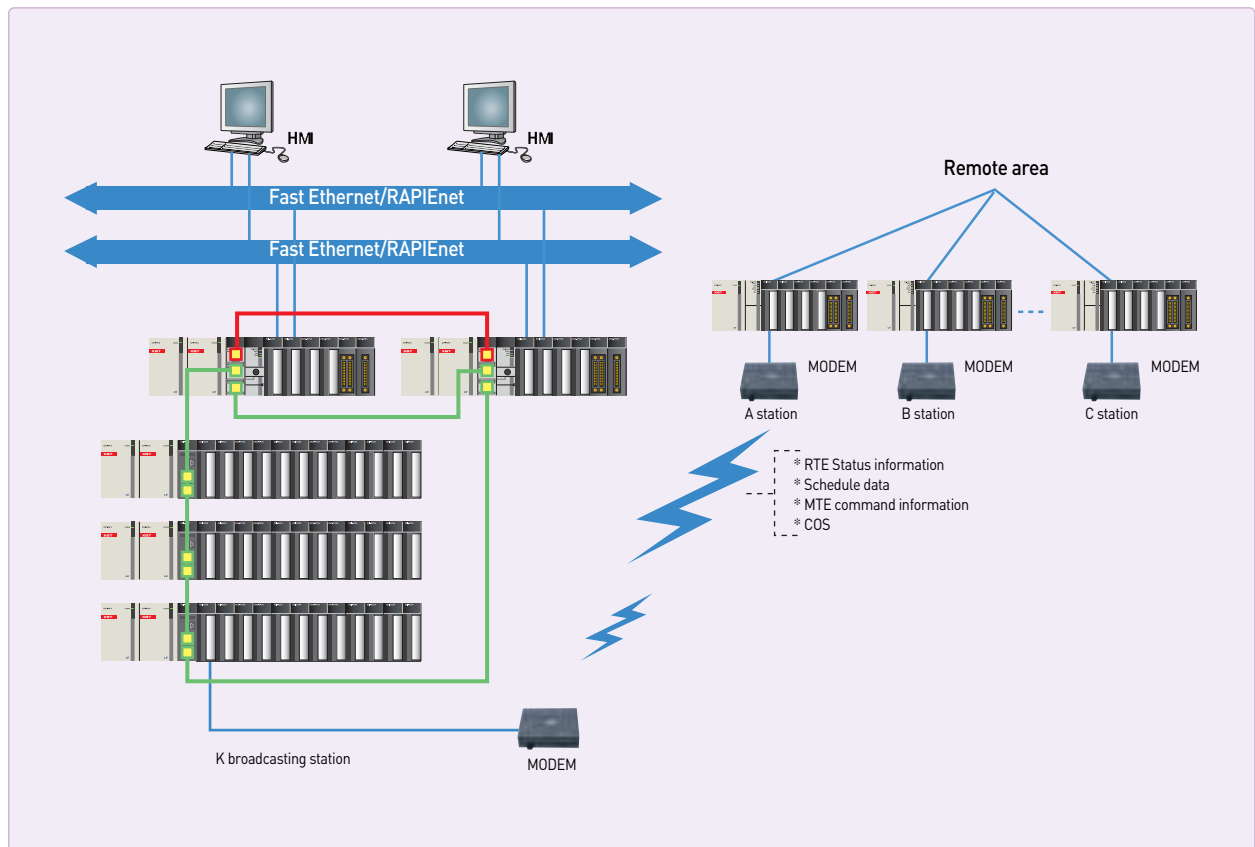







# Network

Along with Ethernet, Profibus-DP, and DeviceNet, XGT series provide the maximum in control integration and communication flexibility.

## Contents

50	General introduction	72	Computer-Link
52	RAPIDnet	74	Communication example [Ethernet]
54	XGT Ethernet system	76	Communication example [Rnet]
56	XGT Ethernet / IP System	78	Communication example [DeviceNet]
58	XGT Ethernet switching hub	79	Communication example [SyCon setting Profibus, DeviceNet]
59	XGT Fnet system	80	SMART I/O [Stand alone]
60	Computer-Link	81	SMART I/O [Modbus/TCP, Ether Net/IP Adapter]
62	Rnet system	82	SMART I/O [DeviceNet adapter]
64	DeviceNet system	83	SMART I/O [Profibus-DP adapter]
66	Profibus-DP [Pnet] system	84	SMART I/O [Rnet adapter]
68	Profibus-DP[Pnet] Slave I/F system	85	SMART I/O [Features]
69	Profibus-DP [Pnet] Remote I/F system		
70	Network/BACnet/IP I/F system		

## Features

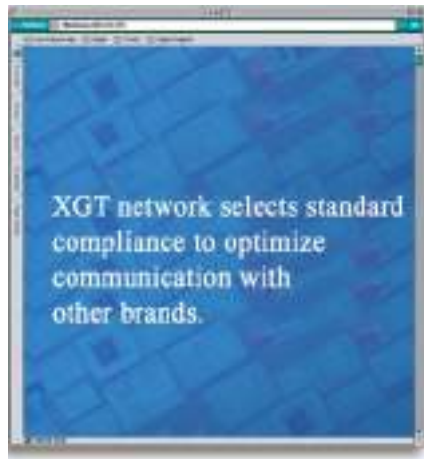

### RAPiEnet

- Communication speed: 100Mbps
- Dual port (T.Pair / F.Optic / Hybrid)
- Built-in high performance industrial switch
- Cyclic Communication (Broadcast Service)
  - 1block :200word
  - Send 64block / Receive 128block
- H/W based Dual port Full duplex Switching
- Real-time / Non real-time service

### Fast Ethernet(FEnet)

- Support max media speed 1Gbps
- Support 1Ch 2Port
  - Line topology configuration with relay parameter setting
- Server standard maximum communication load 5,000pps
- Fiber optic module(XGL-EFMTB) has replaceable connector, communication speed is improved to 1Gbps and maintenance is easy.
- XG5000 old and new version available.
- User defined frame UI enhancements make it easier to use.
- Various diagnostics are possible by strengthening log function.

### XGT Ethernet / IP

- EtherNet/IP Conformance Test Suite Version 2.10
- 100BASE-TX/100Mbps full duplex
- No additional switch or hub (built-in switch)
- Wiring reduction and flexible installation
- Auto cross over function
- Various diagnostic function and network status information

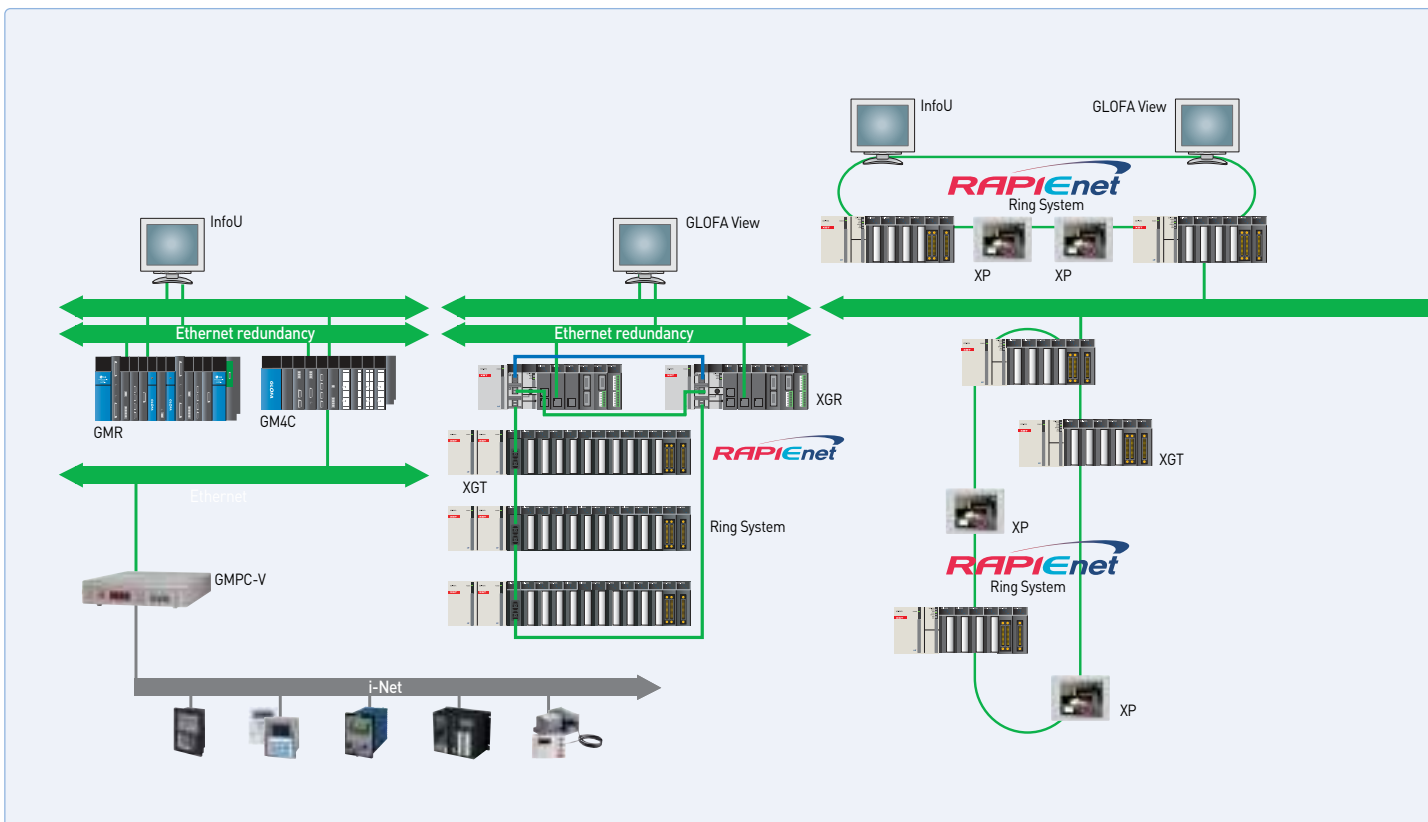

**XGT Cnet**

- RS-232C/485/422 communication
- Long-distance communication via modem connection
- Various connection to HMI S/W (XGT, Modbus RTU, Modbus ASCII)
- User-defined communication
- Convenient P2P master (XGT, Modbus)

**XGT Fnet**

- Dedicated network for LS PLC
- Easy high-speed link parameter setup
- 1Mbps high-speed communication
- Max. 750m
- Max. 6ea repeater available (Max. expansion 5.25km)
- Network management through Auto scan

**XGT Rnet**

- High-speed communication : 1Mbps
- Long communication distance : Max. 750m
- Max. 6 repeaters (up to 5.25km)
- Network management using Auto-scan (Slave module information)

**XGT Dnet (DeviceNet)**

- Connectable to other PLCs and control device
- Compliance of the ODVA standard
- Flexible communication speed setting: 125/250/500Kbps
- Multi-drop and T branch connection
- Long communication distance: Max. 500m

**XGT Pnet (Profibus-DP)**

- Optimum communication for a master automation device and distributed slave I/O devices
- Fast slave communication omitting application layer
- Long communication distance: Max. 1200m
- Communication using High-speed link parameter

**Installation number of network module available**

Item	XGK / XGI / XGR CPU
Total network module	24
High-speed link module	12
P2P service	8

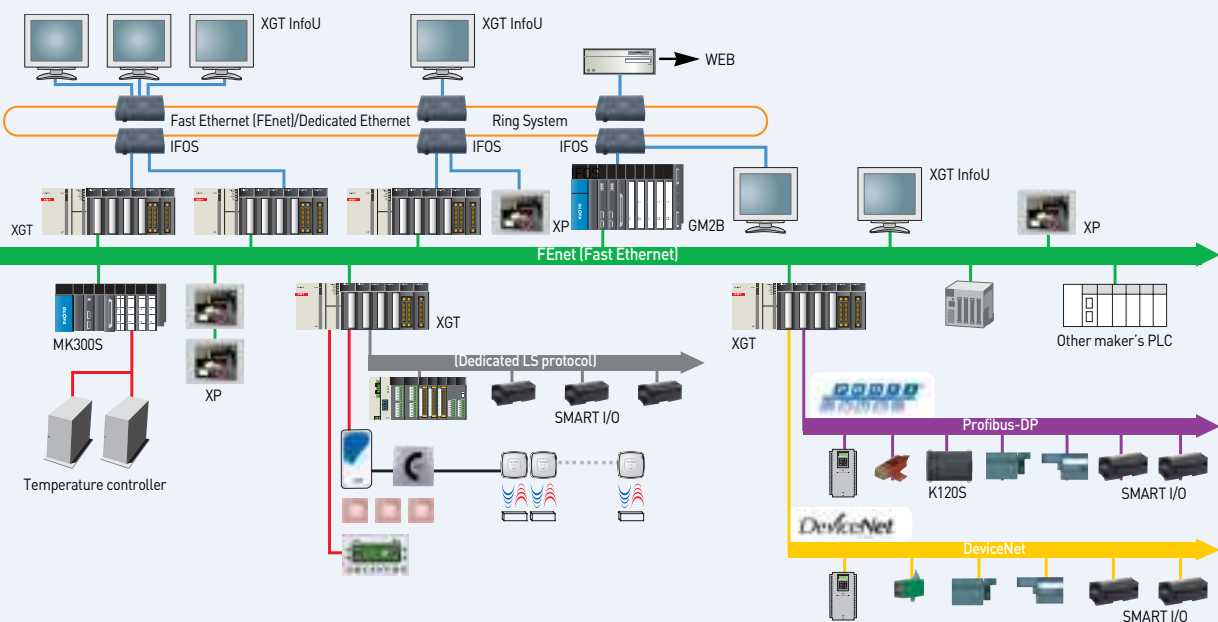

## Features

### 100Mbps Dual Port Ethernet

- Communication speed : 100Mbps
- Dual port (T.Pair / F.Optic / Hybrid)
- Built-in high performance industrial switch
- Cyclic Communication (Broadcast Service)
  - 1block : 200word
  - Send 64block / Receive 128block
- Event Communication (Peer to Peer Service)

### Hardware based Full duplex switching

- Dual port full duplex switching (Forwarding/Receiving)
- Real-time / Non real-time service (Frame)

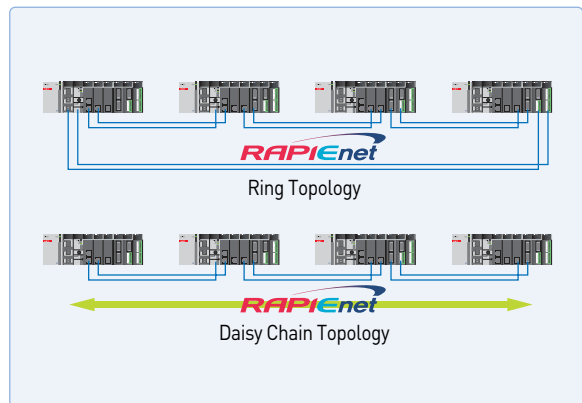

## Redundancy System

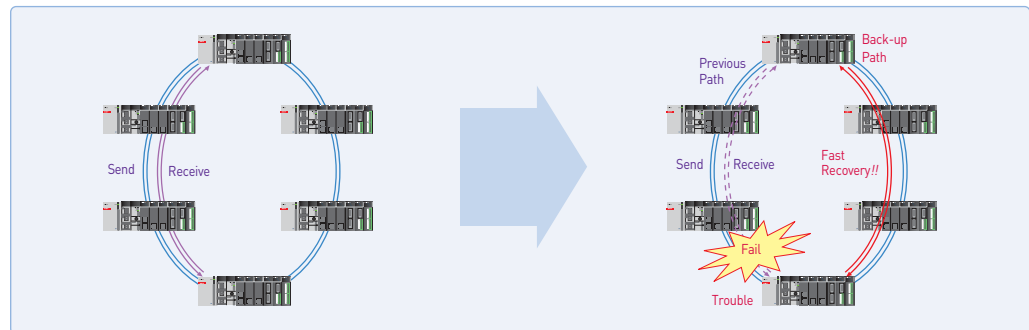

## Hybrid System

- Twisted pair, Fiber optic, Hybrid(T.P+F.O)

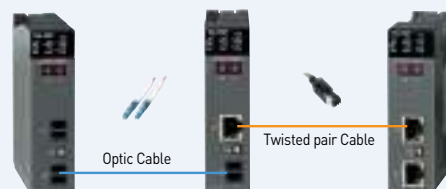

## Intelligent Diagnostic Functions

- Alarm for station number collision
- Cable distance measurement (Twisted pair cable)
- Convenient wiring using auto cross over
- Various diagnosis and Network status information
  - (a) CPU status
  - (b) Communication module status
  - (c) Communication service (HS link, Dedicated service, P2P) status
  - (d) Auto scan function to supply module information within the network
  - (e) Packet and Data ring monitoring receiving to Communication module
  - (f) Module diagnosis via network

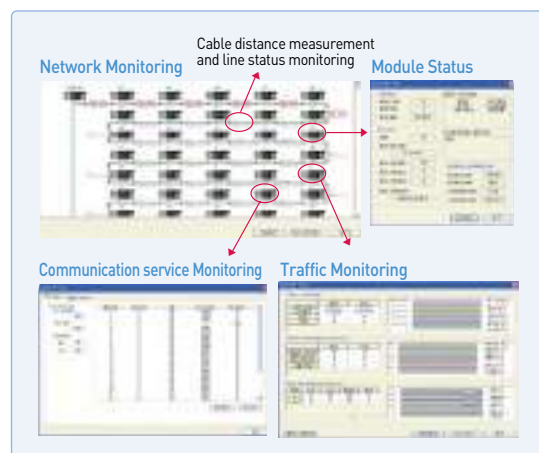

## Specification

Item		Specification		
		100BASE-FX	100BASE-TX	
Transmission	Transmission speed Media	100Mbps Fiber optic	100Mbps Twisted Pair	
	Transmission method	Base band		
	Topology	Daisy Chain, Ring topology		
	Distance (Node to node)	2km	100m	
	Max. distance (Node to node)	128km	6,400m	
	Max. Node	64nodes		
	Max. Protocol	1,516bytes		
	Media access method	CSMA/CD		
	Frame error check	CRC 32 = X <sup>32</sup> +X <sup>31</sup> +X <sup>24</sup> +...+X <sup>2</sup> +X+1		
	Max. Number For PLC of installation	For PC	1	
	Mountable slot	For PLC	Main base ~ 7 <sup>th</sup> Expansion base (XGK-CPUH/XGI-CPUU) Main base ~ 3 <sup>rd</sup> Expansion base (XGK-CPUS/CPUA) Main base ~ 1 <sup>st</sup> Expansion base (XGK-CPUE)	
		For PC	PCI slot	
Communications device	Communication method	P2P High speed link		
	Data block	Client / Server	Multicast, Unicast	
	Data per block	700word × 64Block	12,800word	
	PLC ↔ PLC	●	●	
	PLC ↔ PC	●	●	
Fail Safe	Dual communication line	●		
	Recovery Time	Within 10m		
	Bypass of the fail station	●		
Network diagnosis	Cable distance measurement	●		
	Station number collision detection	●		
Dimension (mm)	PADT	●		
	For PLC	98(H) × 27(W) × 90(D)		
Current consumption (mA)	For PLC	18(H) × 120(W) × 174(D)		
	For PLC	Twisted pair: 330, Fiber optic: 670, Mixed: 510		
Wight (g)	For PLC	Twisted pair: 630, Fiber optic: 630		
	For PLC	Twisted pair: 102, Fiber optic: 109, Mixed: 105		
	For PLC	Twisted pair: 104, Fiber optic: 128		

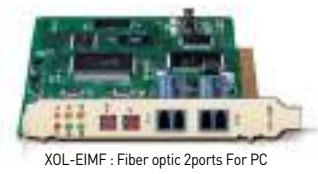

## Redundancy rack type expansion system

- Built-in type for CPU (Redundancy CPU)
  - Max. 31expansion base
- Easy installation
  - Base Auto scan
  - Analog module setup with I/O parameter
  - Easy programming for analog using global variable
  - Max. 24 communication module
- Long distance expansion (Fiber optic: 2km) and loader connection
- Twisted pair/ Fiber optic/ Mixed type communication modules for various system environment

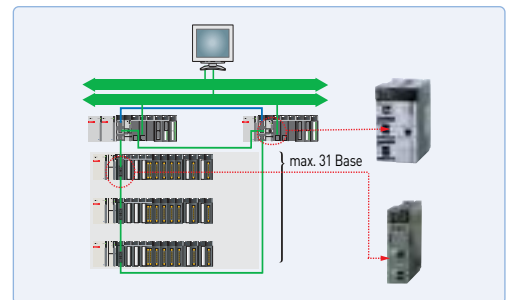

## Controller Level communication

- XGK/XGI/XGR PLC2PLC communication
- Enable to configure Daisy chain without External switch
- Service periodic: within 5ms

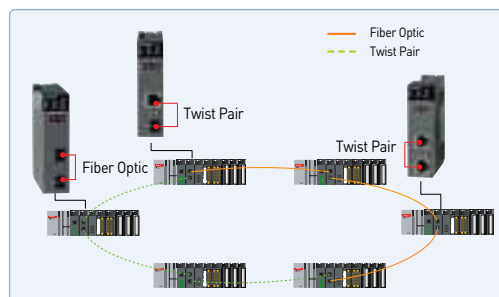

## System configuration

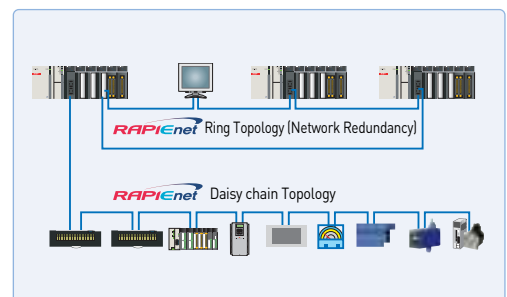

## Features

- Support max media speed 1Gbps
- Support 1Ch 2Port
  - Line topology configuration with relay parameter setting
- Server standard maximum communication load 5,000pps
- Fiber optic module(XGL-EFMTB) has replaceable connector, communication speed is improved to 1Gbps and maintenance is easy.
- XG5000 old and new version available.
- User defined frame UI enhancements make it easier to use.
- Various diagnostics are possible by strengthening log function.



## Specification

### Open Ethernet

Item		Product Name		
		XGL-EFMTB	XGL-EFMFB	
Transmission Specification	Baud rate	10/100/1000Mbps	100/1000Mbps	
	Transmission Type	Base Band		
	Max. extended length between nodes	100m(Node-Hub)	2km	
	Max. segment length	-	-	
	Max. number of nodes	Hub connection(Up to 9 recommended )	30/Segments	
	Distance between nodes	-	Integral times of 0.5m	
	Max. protocol size	1,500 Byte		
	Access method to service zone	CSMA/CD		
	Frame error check	CRC 16 = X <sup>15</sup> + X <sup>14</sup> + X <sup>13</sup> + ... + X <sup>2</sup> + X + 1		
Basic Specification	Current consumption (5V)	100Mbps	560mA	750mA*
		1Gbps	900mA	740mA*
Weight	146 g	156 g	-	

\*Formerica SFP standard

### Dedicated Ethernet

Item		XGL-EDMT	XGL-EDMF
Communication spec.		10/100 BASE-TX	100 BASE-FX, Fiber Optic
Protocol		Dedicated protocol	
Service	With LS PLCs	High-speed link, P2P service	
	With other devices	-	
	Application	XG5000 service	
Sending/receiving data		200 words /block	
No. of connection stations		64 stations	
General use		High-speed link communication among LSIS PLCs	
Purpose		UTP/STP Category 5	62.5/125μm, multi-mode, SC connector
Current consumption (mA)		410	630
Weight (kg)		0.11	0.15

## How to replace an existing product(XGL-EFMT/F)

### Hardware replacement

- Please remove existing installed modules and install new module.
- If the CPU is running, please replace it with the module replacement wizard or the module replacement switch..

### Cable connection

- Please connect the existing cable to Port 1 of the new module. If you connect to Port 2, DHCP function is restricted.
- For optical cables, please use the LC type cable or you must use an LC-SC converter for existing cable.

### Program and parameter setting

When using existing functions after "b" Type module replacement, no parameter setting is required..

### CPU and XG5000 version

To use the new function of B type, please refer to the below version information to upgrade.

Series	Product name	Version
XGK CPU	XGK-CPUx	V4.55 or higher
	XGK-CPUxN	V1.05 or higher
XGI CPU	XGI-CPUx	V4.06 or higher
	XGI-CPUxN	V1.12 or higher
XGR CPU	XGR-XPUH/T(H)	V2.72 or higher
Software	XG5000	V4.10 or higher

## XGL-EFMTB, XGL-EFMFB type s' added or improved

**The new model offers a variety of additional functions, please refer to the user manual for details.**

- Support max media speed 1Gbps (In case of fiber optic type, supported when 1Gbps SFP is installed)
- Support 1Ch 2Port (internal switching function support)
  - Line topology configuration with relay parameter setting
- Server standard maximum communication load 5,000pps
- Fiber optic module(XGL-EFMTB) has replaceable connector, communication speed is improved to 1Gbps and maintenance is easy.
- XG5000 old and new version available.
- User defined frame UI enhancements make it easier to use.
- Various diagnostics are possible by strengthening log function.

## Features

- Extensive Client Messaging Support
- Encapsulated Messages, Explicit Messaging
- Class 3 Connected Explicit Messaging(Server Only)
- Class 1 Connected Implicit(I/O) Messaging(Cyclic I/O Service Only)
- EtherNet/IP Conformance Test Suite Version 2.10
- 100BASE-TX , 100Mbps/ Full Duplex
- Max.24ea available on 1 CPU module (Main base / Extension base)
- No additional switch or hub (built-in switch)
- Wiring reduction and flexible installation
- Auto cross over function
- Various diagnostic function and network status information
  - Communication module status
  - P2P status
  - Auto Scan function
  - Packet and data status
  - Communication module diagnosis through network



## System configuration

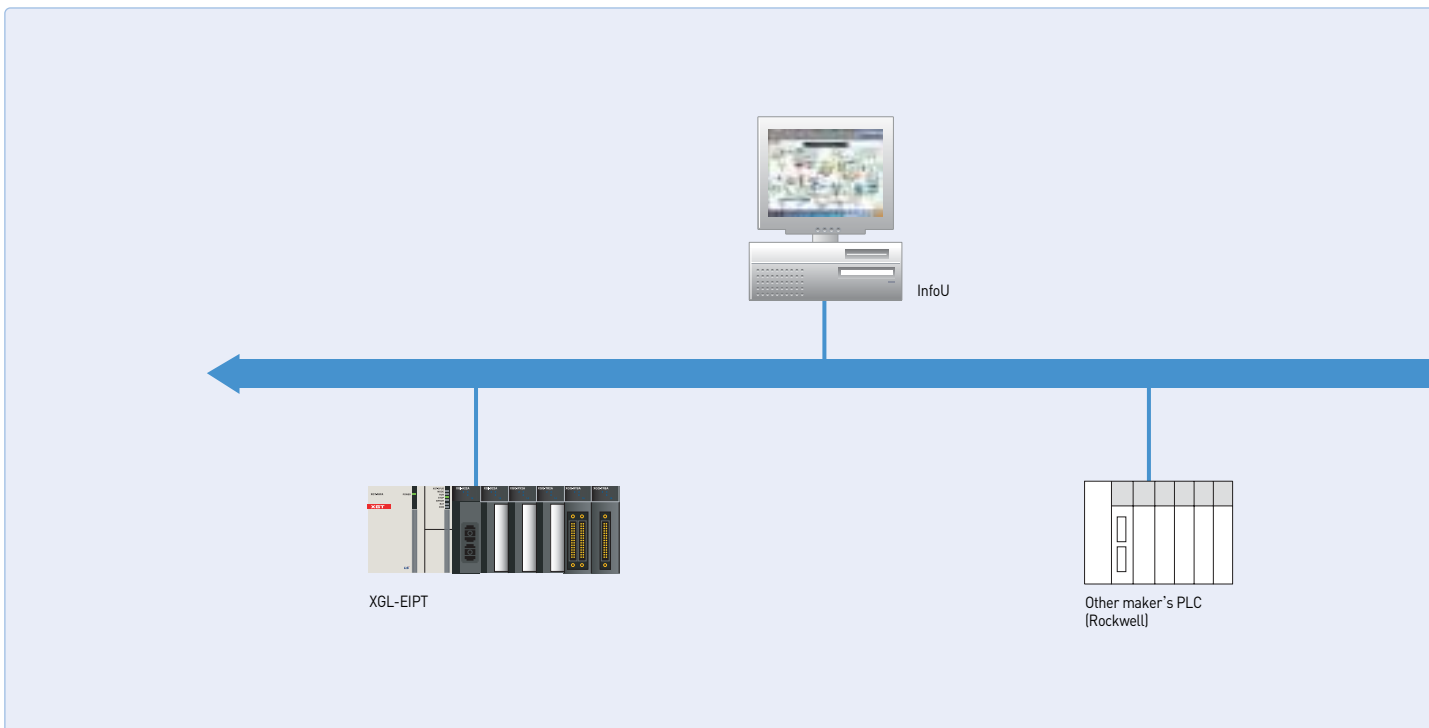



## Specification

Item		XGL-EIPT
Communication speed		100Mbps
Modulation method		Base band
Max. expansion length between nodes		100m
Access method		CSMA/CD(Full Duplex)
Topology		Line type (Built-in switch), Star type
Service	Periodic communication	Implicit IO Client
	Non-periodic communication	UCMM Client
	Periodic server	Implicit IO Server
Diagnostic function		Module information, Auto Scan, Media Information, Ring test
Number of connection (Client/Server)	TCP	64/128
	CIP (IO communication)	64/128
Max. number of service		8
Max. number of module		24
Media		UTP/STP Category 5
Dimension		98(H) × 27(W) × 90(D)
Current consumption (mA)		400mA
Weight (g)		102

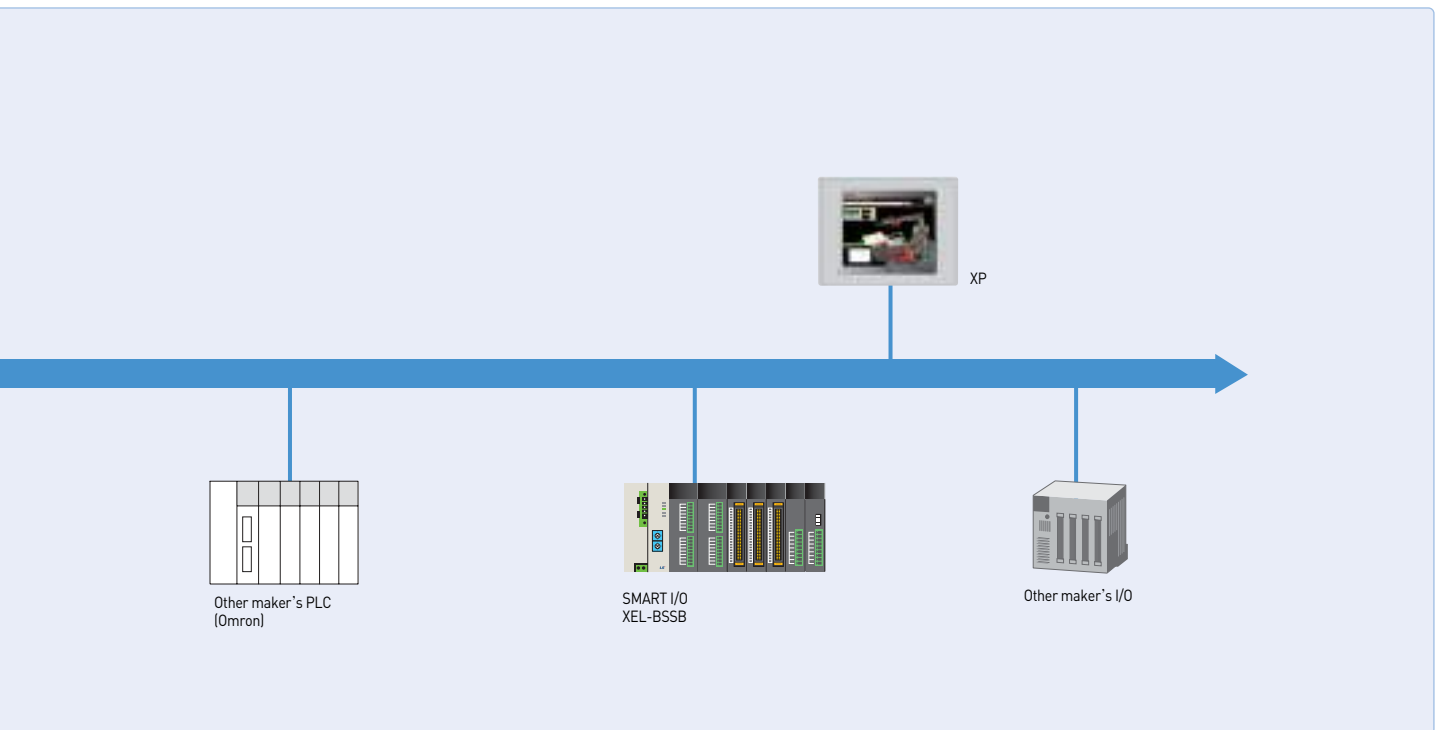

## Features

- Rack type: No external power
- Reliability for industrial standard
- Auto Crossover
- FG (Frame Ground) for RJ-45 connector
  - Decreased communication error by shielded FTP/STP cable



## Specification

Item		XGL-EH5T
Transmission	Communication speed	10/100Mbps
	Port type	10/100BASE-TX, TP cable, RJ-45 socket, 5ports
	Interface	Auto-Crossing, Auto-Nego., Auto-Polarity
	Distance	100m
	Diagnosis	LED (PWR, Link status, Data)
Current consumption (mA)		550
Weight (g)		90

## System configuration

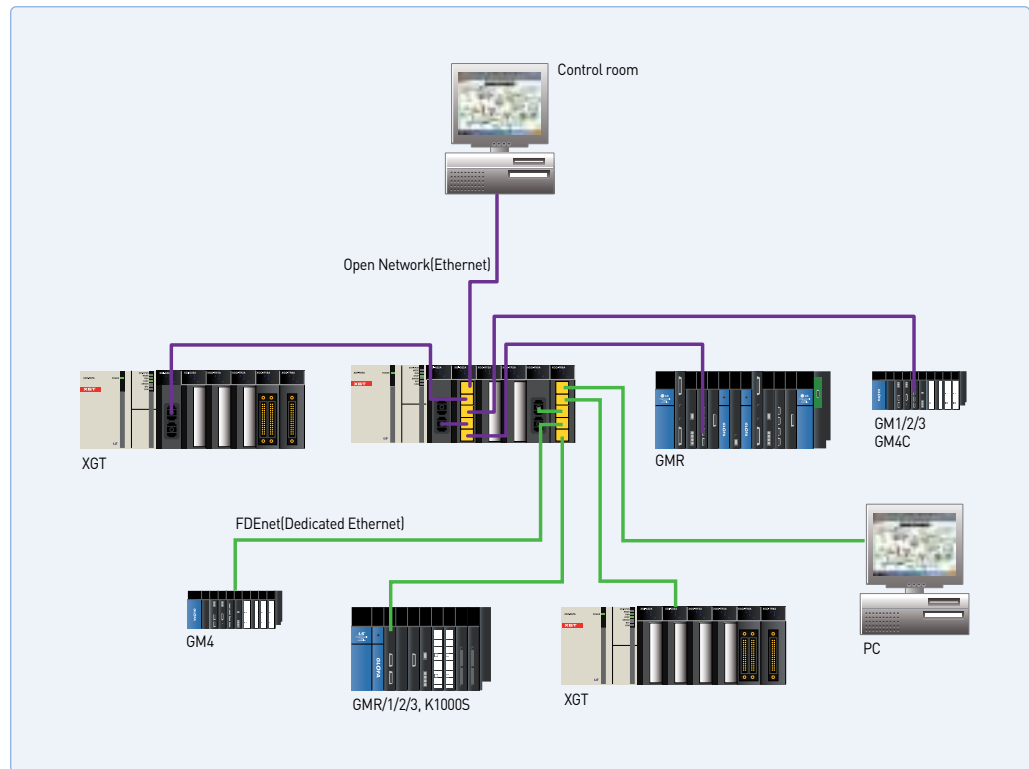

## Features

- Dedicated network for LS PLC
- Easy high-speed link parameter setup
- 1Mbps high-speed communication
- Max. 750m
- Max. 6ea repeater available (Max. expansion 5.25km)
- Network management through Auto scan
- Max. 12ea on 1ea base
- Deterministic Network through Token Passing & Broadcasting
- 3,840 Word for each station (Send 1920 Word /Receive 1920 Word)
- Max. number of block: Send 32blocks, Receive 64blocks, 60words for each block
- Max. communication points: 3840words (64block × 60word)
- Setup: Parameter download via XG5000
- Diagnosis by XG5000: Communication module information, High speed link fault, Auto scan



## Specification

Item	Description
Communication speed	1Mbps
Encoding method	Manchester Biphase-L
Transmission length (for one segment)	Max. 750m
Transmission length (via repeater)	Max. 750m × (6ea repeaters+1)=5.25km
Transmission cable	Twisted pair shield cable
Max. number of connection	64stations (32stations /segment, 64stations for repeater)
Max. protocol size	256 bytes
Access method	Circulated Token Passing
Frame error check	CRC 16 check
Max. number of installation	12ea
Installation base	Main base or expansion base
Current consumption (mA)	410
Weight (g)	120



## System configuration

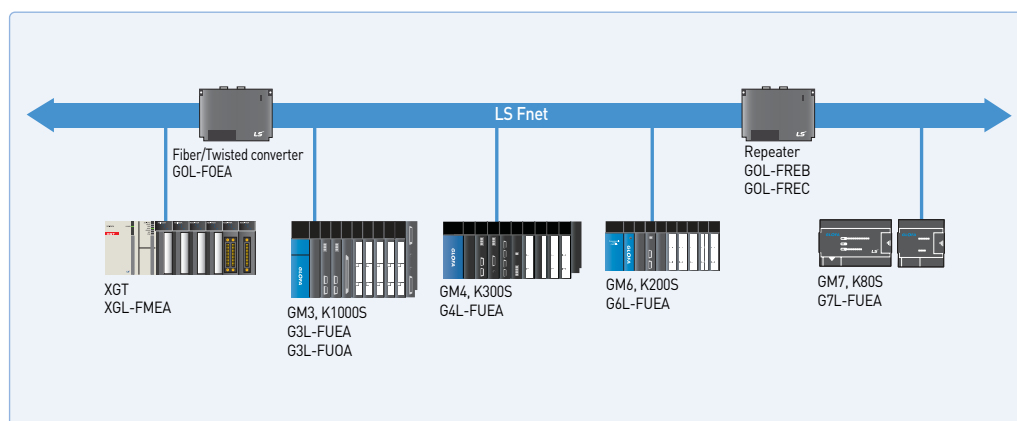

## Features

- Smart server recognizes the protocol (XGT dedicated communication or Modbus RTU/ASCII) automatically and operates.
- Repeater mode is able to use as an insulated repeater or convert RS-232C to RS422/485.
- Contains built- in termination resistor and it can be set in the basic parameter window.
- Easy protocol editing and communication parameter setting: XG5000
- Long-distance communication via modem connection
- Dedicated protocol for multi-drop configuration connectable up to 32 units
- RS-232C/422 communication port
- Flexible communication speed setting (300~115,200bps)
- Supporting full duplex and half duplex communication
- Max. 12 modules available in one CPU
- P2P service: User-defined communication and XGT/ Modbus master
- Various connection to MMI S/W (XGT, Modbus RTU, Modbus ASCII)
- Various diagnosis functions using XG5000 (I/O, link status, service status)
- Communication service information (Dedicated service, P2P service)
- Supporting simultaneously dedicated service in remote connection
- Communication without additional setting when replacing communication module



## Various independent operation mode

- Operation mode
- Dedicated protocol mode (Simultaneous support)
- Program upload/download by XG5000 protocol (RS-232C)  
Communication using LSIS dedicated protocol
- User-defined communication of P2P mode and XGT/Modbus master

## Communication via RS-232C/422

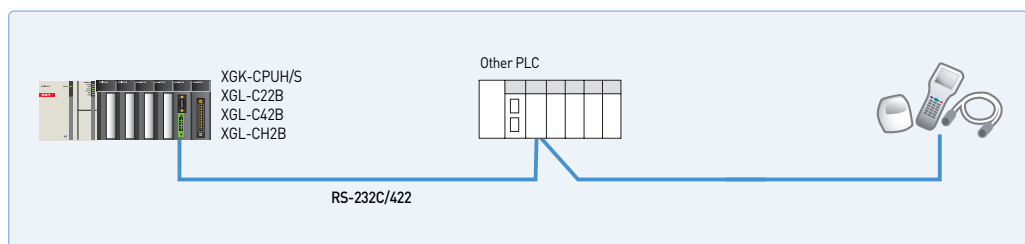

## 1: N and N: M connection (LSIS and other)

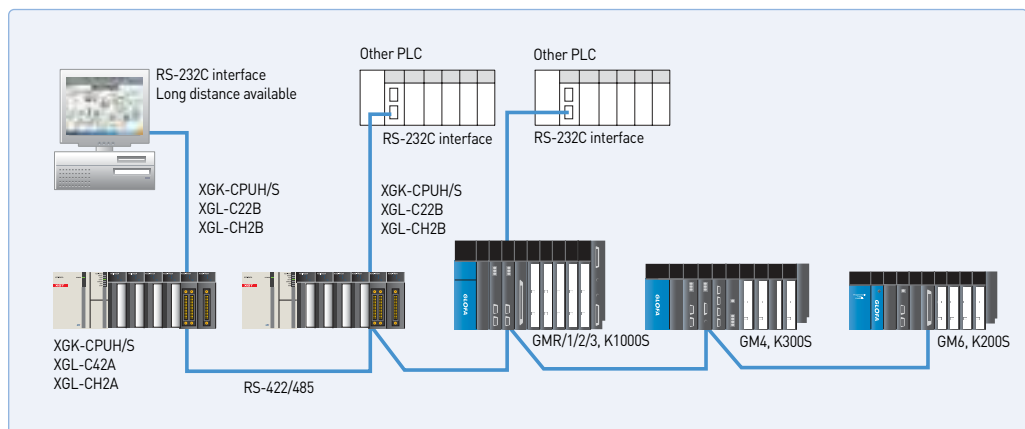

## Specifications

Item		Specification		
		XGL-C22B	XGL-CH2B	XGL-C42B
Serial communication channel	RS-232C	2 channels	1 channel	-
	Line config	Conforms to RS-232C standard		
	RS-422/485	-	1 channel	2 channels
	Line config	Conforms to RS-422/485 standards		1:1, 1:n, n:1
Modem connection function		Remote communication with external devices is available via public telephone line by connecting external modem to the module.		-
Operating mode (specified per port)	P2P	XGT client, Modbus ASCII/RTU client, Use defined communication		
	SERVER	XGT server, Modbus ASCII/RTU server		
Data type	Start Bit	1		
	Data Bit	7 or 8		
	Stop Bit	1 or 2		
	Parity	Even/Odd/None		
Synchronization type		Asynchronous type		
Detecting error		BYTE SUM, WORD SUM, BYTE XOR, DLE AB, DLE SIEMENS, LSI CRC, CRC 16, BYTE SUM 2' COMP, BYTE SUM 1's COMP 7BIT SUM, 7BIT XOR, CRC 16 IBM, CRC 16 CCITT		
Transmission speed (bps)		300/600/1,200 / 1,800 / 2,400 / 3,600 / 4,800 / 7,200 / 9,600/19,200 / 38,400 / 57,600 / 64,000 / 76,800 / 115,200 bps		
Station No. setting		Setting range : 0-31, Max. station No. : 32 stations		
Transmission Distance(m)		RS-232C: Max.15 (extendible if modem used)		-
		-	RS-422/485: Max. 1,200m	
Diagnosis function		Status LED diagnosis XG5000 diagnosis service(Frame monitor, Status by service, Loop-Back diagnosis) History, Saving history		
Appearance size(mm)		98(H) X 27(W) X 90(D)		
Current consumption(mA)		420	480	520
Weight(g)		121	119	116

\* XGL-CH2A / C42A and XGL-CH2B / C42B differ from RS-422 / 485 communication connector wiring, you refer to the operation manual.

## Modbus

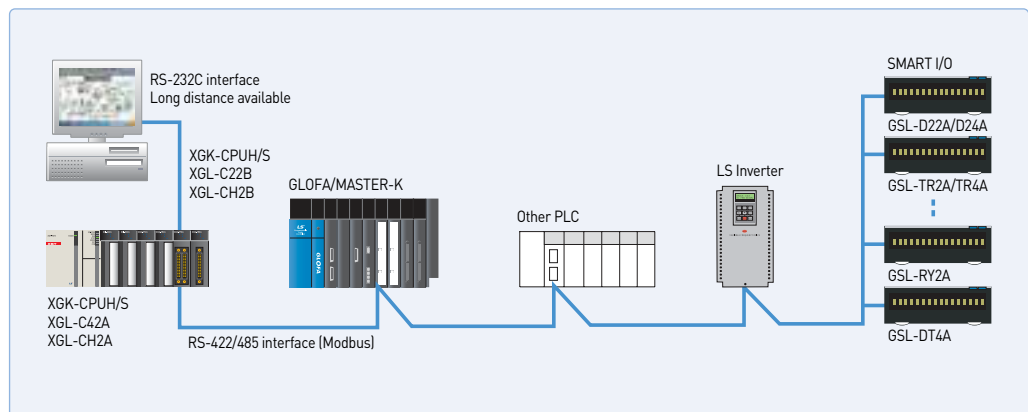

## Cnet cable connection

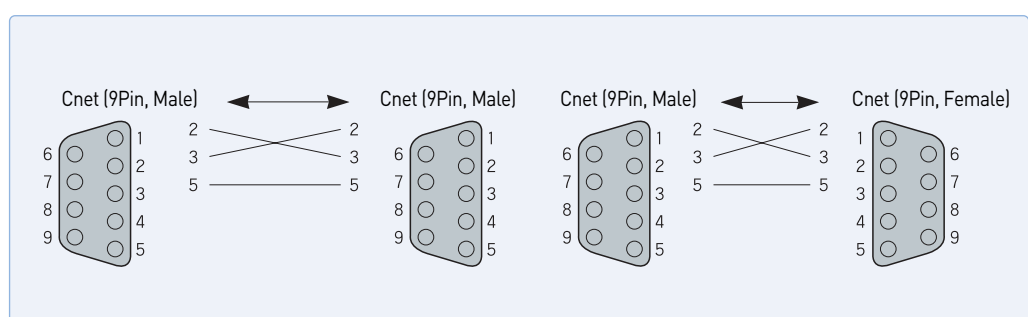

## Features

- Communication speed: 1Mbps
- Communication distance: Max. 750m
- Available to use max. 6 repeaters (Up to 5.25Km)
- Network management using Auto-scan (Slave module information)
- Multi-drop network with smart I/O
- Network diagnosis and monitoring by XG5000
- Max. 63 stations of slave modules controlled by one master module



## System configuration

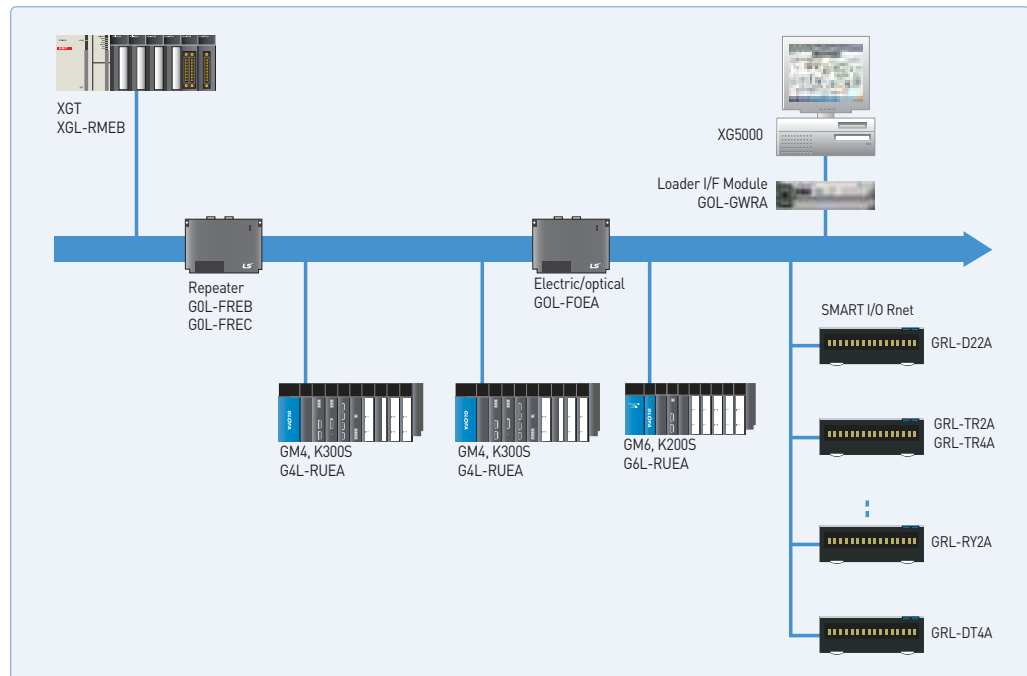

## Specifications

Item		Specifications
Transmission Speed		1Mbps (Rnet I/F modules common)
Max. Tx distance		Max. 750m
Connection Cable		Twisted pair shielded cable - LIREV-AMESB 1Px22AWG (7/0.254):LS Cables
Maximum stations connected	Network	Master station 1[station no:0(fixed)] + Slave station 31[station no:1~63] = Max. 32 stations (In case of 32 stations, you have to use repeater.) - Only 1 master is available in the network.
Diagnostic function		XG5000 : High Speed Link Monitoring
System characteristic		Available detachment and attachment of slave module during communication
Terminal resistance(Ω)		110(5%, 1/2W)
Master/Slave operation		Only available as Master
XG5000 (HS Link)	Data Processing unit	Byte
	Tx/Rx cycle	Selection among 20ms, 50ms, 100ms, 200ms, 500ms, 1s, 5s, 10s(default :200ms)
	Max. Communication points.	3,720bytes(slave 31stations * 120bytes/station)
	Max. Block number	63(setting range : 0~62)
	Max. points by Block	120 Byte(60words)
	Max. Tx. Block number	32 Blocks
	HS Link number	Max. 12
Specification	Max. module mounted	12 modules(Main Base + Extension Base)
	Internal current consumption(mA)	410
	Weight(g)	115

## SMART I/O

- Reduction of wiring and real-time control of distributed I/O
- Various I/O module (16/32 points)



## Repeater specifications

Item	Specifications
Type	G0L-FREB: AC110V ~ AC220V, G0L-FREC: DC 24V
Communication speed	1Mbps
Transmission method	Twisted pair shield cable
Transmission distance	Max. 750m per repeater
Max. number of installation between stations	Max. 6 repeaters
Max. distance between stations	5.25Km (when 6 repeaters are installed)
Fault data reception	Error data transmission
Frame error check	CRC 16 check

## Network cable and peripheral devices

Item	Specifications	Remarks
Twisted pair electric cable	LIREV-AMESB, 2 × 1mm, 18AWG	LS cable
RF terminator	110 Ω, 1/2 W	-



## Features



- DeviceNet protocol
- Direct control of various I/O devices via Dnet system
- Max. 63 slave modules controlled by one master module
- Flexibility in network configuration: Multi-drop and T branch connection
- Connectable to other master module and various slave modules
- Providing 'Auto Network Scan' function and various information with configuration tool (N Configurator)
- Communication using High-speed link parameter
- Connectable to various slave I/O including other module  
[Common I/O, Actuator, Switch, Optical switch, Valve, Inverter, A/D module, Position controller etc.]
- Automatic monitoring of slave modules in the network: Auto-scan (XG5000)
- Easy expansion: up to 12 master modules
- Network setting by N Configurator/XG5000(Parameter setting, diagnosis and monitoring)

## System configuration with LSIS products

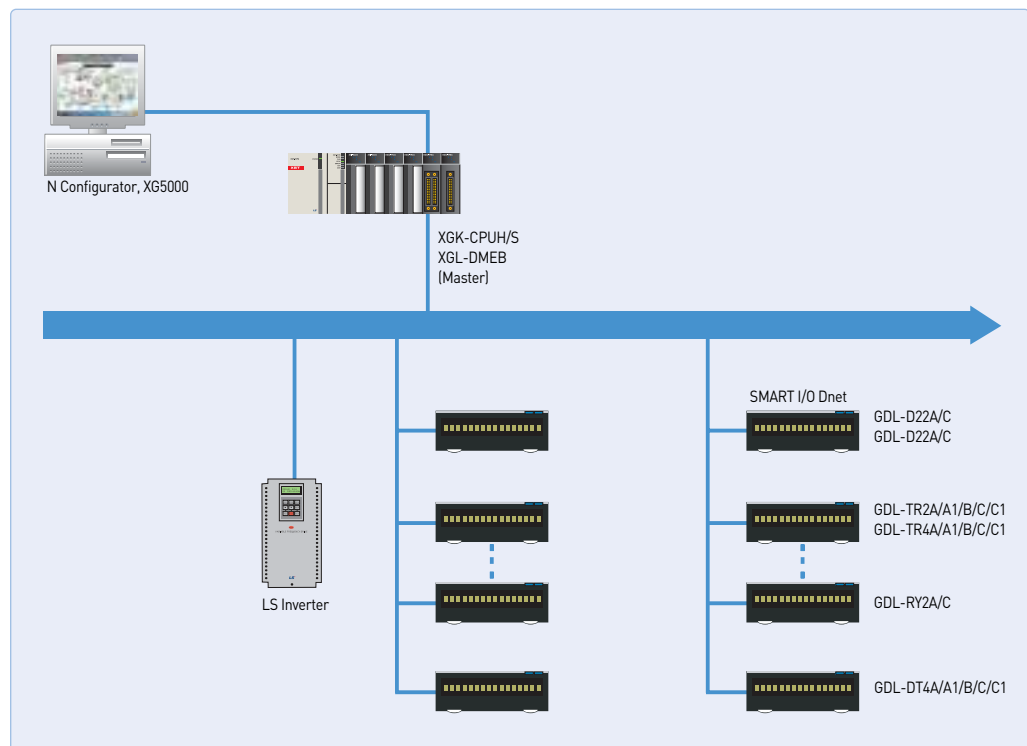



## Specifications

Item		Performance Specifications	
Transmission Specification	Transmission Speed (kbps)	125/250/500	
	Transmission Type	I/O Connection	G2, UCMM
		I/O Communication	Poll, Bit strobe, COS, Cyclic
	Communication distance(m)	Thick Cable	500 (125kbps)/250 (250kbps)/100 (500kbps)
		Thin Cable	100 (125/250/500kbps)
	Terminal resistance (W)	121 (1%, 1/4W)	
	Max.drop length(m)	125 kbps	6 (Max. extended length 156)
		250 kbps	6 (Max. extended length 78)
		500 kbps	6 (Max. extended length 39)
	Data Packet	0-8 Bytes	
	Message Access Control	CSMA/NBA	
	Network Structure	Trunk/drop line Power/Signal cable inside the identical network cable	
	Bus Type	Poll type	
	Max. number of nodes	Up to 64 (including master) MAC IDs (MAC Identifier)	
	System Features	Insertion and removal of node available in voltage On status	
Operation Voltage	DC 24V		
Diagnosis Function	Module: Checks duplicated station/ Checks CRC error N Configurator: Detects defective station/Checks BusOff/Auto-scan function XG5000: Monitors High-speed link		
Master/Slave Operation	Available only in master		
Parameter setting		1) N Configurator (CONFIG Port of Dnet I/F) 2) Setting to High-speed link of XG5000 (RS-232C of CPU module or USB port)	
XG5000 (high-speed link)	Data process unit	Byte	
	Send/Receive period	Select among 20ms, 50ms, 100ms, 200ms, 500ms, 1s, 5s and 10s - Default : 20ms	
	Max. communication point	Send 128,520points, Receive 128,520 points, 16,065 bytes respectively	
	Max. block number	63 (Setting range: 0-62)	
	Max. point number per block	2040 points (255 bytes)	
Basic Specification	Max. modules installed	Up to 12 (available on basic base and added base)	
	Internal-consumed current (mA)	350mA	
	Weight (g)	81g	

NETWORK

## System configuration with other products

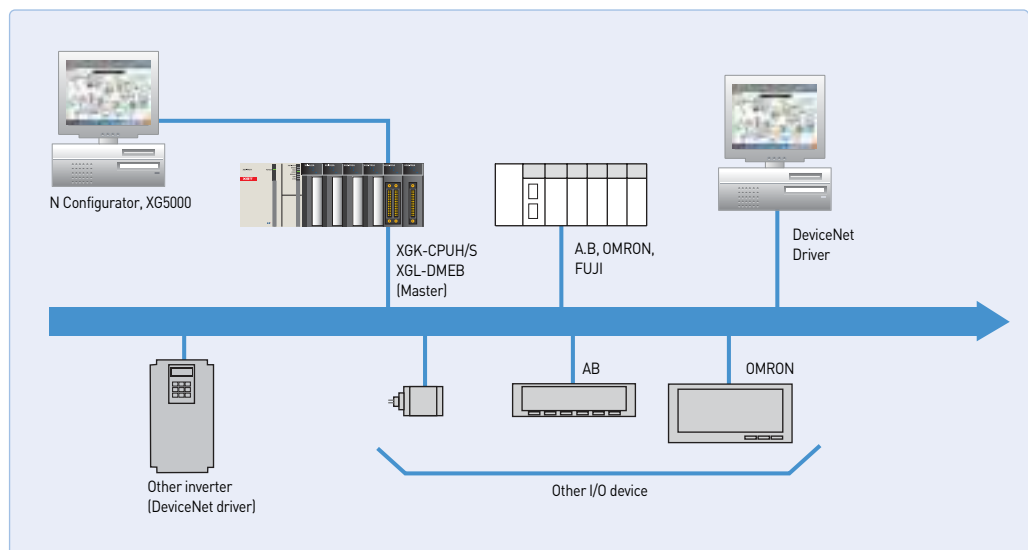

## Features

- Profibus-DP protocol
- Proper to communicate among a master automation device and distributed slave I/O devices.
- Fast slave communication without application layer
- Transmission speed: 9.6Kbps ~ 12Mbps
- Transmission distance: Max. 1,200m
- Max. 126 slave stations available (32 stations per segment)
- Network setting using N Configurator / XG5000 (Parameter setting, diagnosis and monitoring)
- I/O data of master station: 7kbytes
- Automatic monitoring of slave modules in the network: Auto-scan (XG5000)
- Multi master
- Easy configuration tool : N Configurator / XG5000



## System configuration with LSIS products

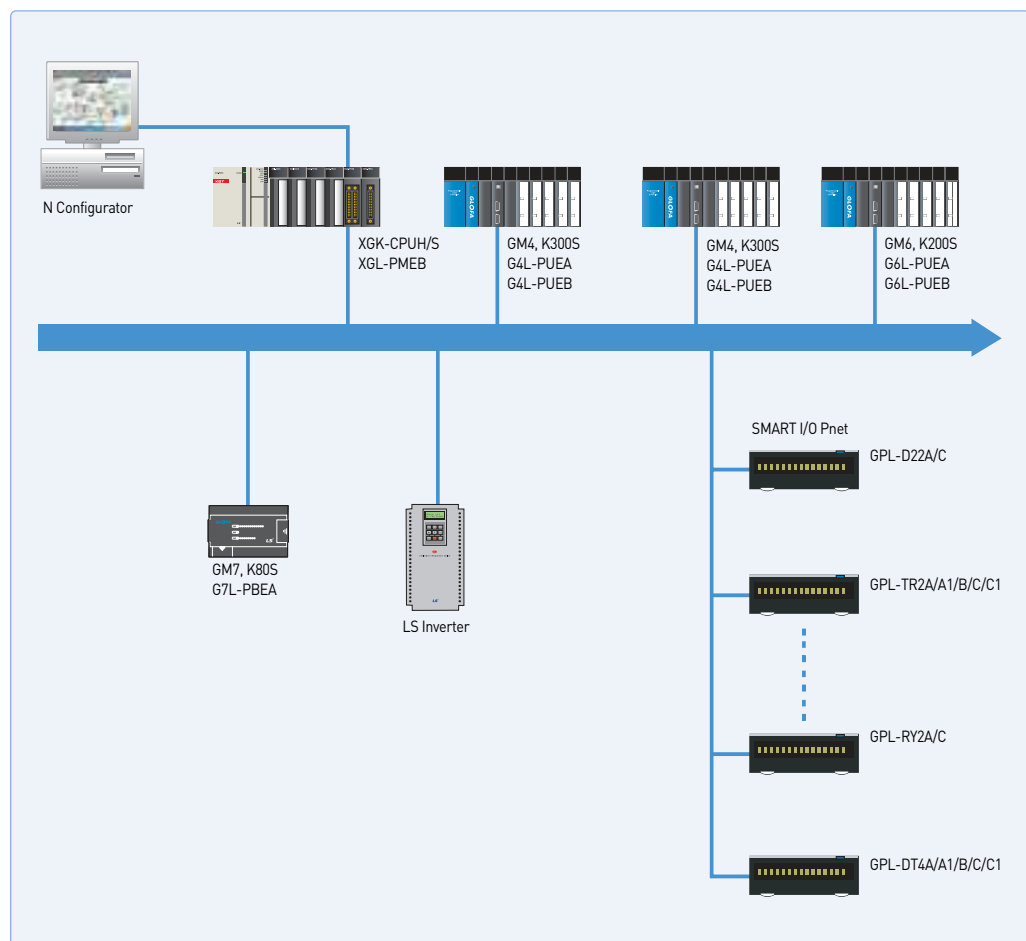

## Specifications

Item	XGL-PMEB	
Module Type	Master	
Network Type	Profibus-DP	
Standard	EN50170/DIN19245	
Interface	RS-485 (Electric)	
Transmission Route	Bus type	
Modulation Type	NRZ	
MAC	Local Token Ring	
Max. Distance & Transmission Speed	Distance (m)	Transmission Speed (bps)
	1,200	9.6k/19.2k/31.25k/45.45k/93.7k
	1,000	187.5k
	400	500k
	200	1.5M
100	3M/6M/12M	
Max. number of stations per network	126	
Max. number of stations per segment	32 (including master & repeater)	
Max. number of modules per node	24 modules	
Cable used	Electric-twist shielded pair cable	
Max. communication size	7 KB	
Max. size per slave	244 bytes	
Max. number of units to be installed	XGK-CPUH/XGI-CPUU	XGK-CPUS/CPUA/CPUE
	12	12
Installation Position	XGK-CPUH/XGI-CPUU	XGK-CPUS/CPUA/CPUE
	Basic base ~ expansion stage 7	Basic base ~ expansion stage 3
Communication Parameters to set	XG5000 , SyCon (XGL-PMEA Dedicated Configuration Tool), N Configurator (XGL-PMEB/C Dedicated Configuration Tool)	
Internal-consumed current(mA)	500	
Weight (g)	88	

## System configuration with other products

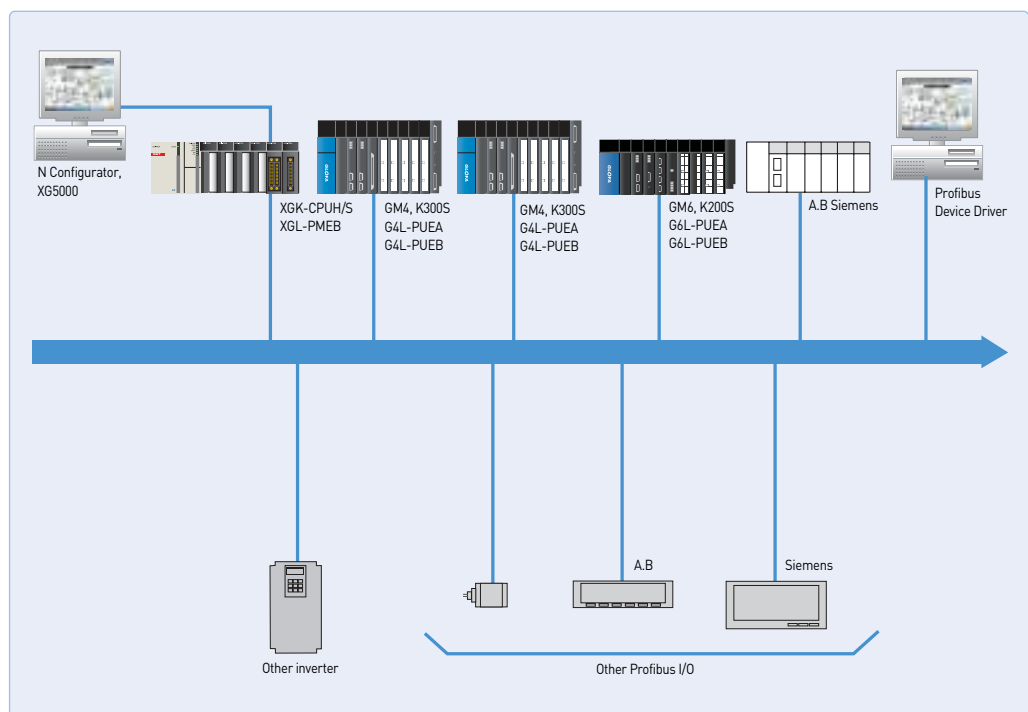



## Features

- Profibus-DP
- Max. 98 stations available
- Other product Master <-> Pnet Slave I/F Module connect
- I/O configuration through XG5000 high-speed link parameter
- Provides online network status monitoring
- Global Command
  - Sync, Unsync, Freeze, Unfreeze

## System configuration with other products

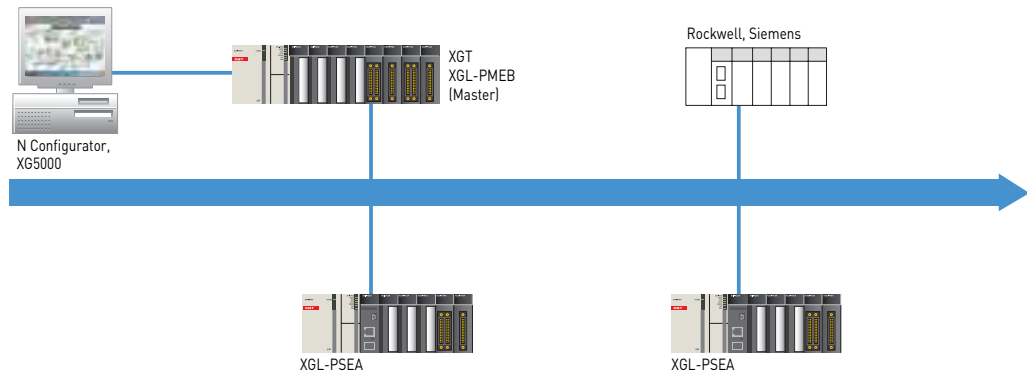

## Specifications

Item	XGL-PSEA					
Standard	EN50170 / DIN 19245					
Interface	RS-485(Electric)					
Media access	Polling					
Topology	Bus					
Modulation	NRZ					
Network Interface	Auto baud rate					
Master / Slave	Slave					
Max. number of slave per network	99					
Max. number of slave per segment	32					
Cable	Shield twisted pair cable					
Max. I/O data	244 byte					
Configuration tool	XG5000					
Transmission distance and speed	Trans. speed(kbps)	9.6	19.2	93.75	187.5	500
	Max. network length (m)	1200	1200	1200	1000	400
	Trans. speed(kbps)	1500	3000	6000	12000	-
	Max. network length (m)	200	100	100	100	-
Max num. of node	99(0~98)					
Max num. of transmission block	24					
Max num. of installation	12ea (XGR: Max. 6ea)					
Installation	XGK-CPUU/H, XGI-CPUU			Main base ~ 7 <sup>th</sup> Expansion base		
	XGK-CPUE, XGI-CPUE			Main base ~ 1 <sup>st</sup> Expansion base		
	XGK-CPUA/S, XGI-CPUH/S			Main base ~ 3 <sup>rd</sup> Expansion base		
	XGR-CPUH/F, XGR-CPUH/T			Main base		
Current consumption (mA)	410					
Weight (g)	103					

# Profibus-DP [Pnet] Remote I/F system

## Features

- Profibus-DP
- Remote base implementation
- Max. 98 stations available
- Various I/O module
  - DI/DO module
  - AI/AO/RTD/TC module
- Provides online network status monitoring
- Hot swap function



## System configuration with other products

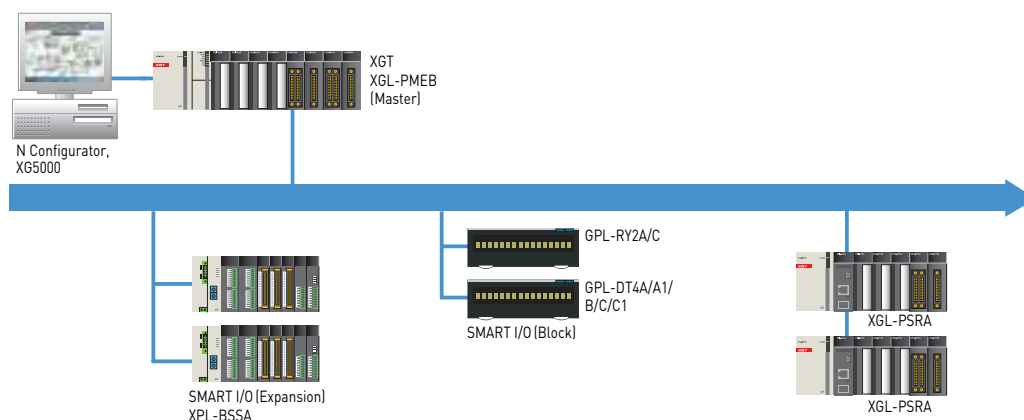

## Specifications

Item	XGL-PSRA					
Standard	EN50170 / DIN 19245					
Interface	RS-485 (Electric)					
Media access	Polling					
Topology	Bus					
Modulation	NRZ					
Network Interface	Auto baud rate					
Master / Slave	Slave					
Max. number of slave per network	100					
Max. number of slave per segment	32					
Cable	Shield twisted pair cable					
Max. number of communication points	244 byte					
Transmission distance and speed	Trans. speed(kbps)	9.6	19.2	93.75	187.5	500
	Max. network length(m)	1200	1200	1200	1000	400
	Trans. speed(kbps)	1500	3000	6000	12000	-
	Max. network length(m)	200	100	100	100	-
Max num. of node	100 (0-99)					
Max. number of installation	12					
Max. digital I/O	768					
Max Analog I/O Channel	Input : 122ch. / Output : 96ch					
Current consumption (mA)	600					
Weight (g)	114					



## Features

- Compatibility: compatible with ANSI/ASHRAE 135-1995
- Provides 100BASE-TX media, and supports 100Mbps/Full Duplex.
- Up to 24 modules can be equipped per CPU module, and can be installed on main base or augmenting base. However, they can be installed only on main base in XGR system.
- With its internal switch function, it requires no switch or HUB, which reduces wires and provides flexibility in terms of installation.
- Makes cable works easier with its auto cross-over function.
- Provides various diagnosis functions and status information for modules and networks.



## System configuration

XGL-BIPT module can be connected to BACnet Network using client/server, XGL-BIPT module is used as BACnet server, and sub-device can be controlled by being connected with exclusive power line communication (PLC).

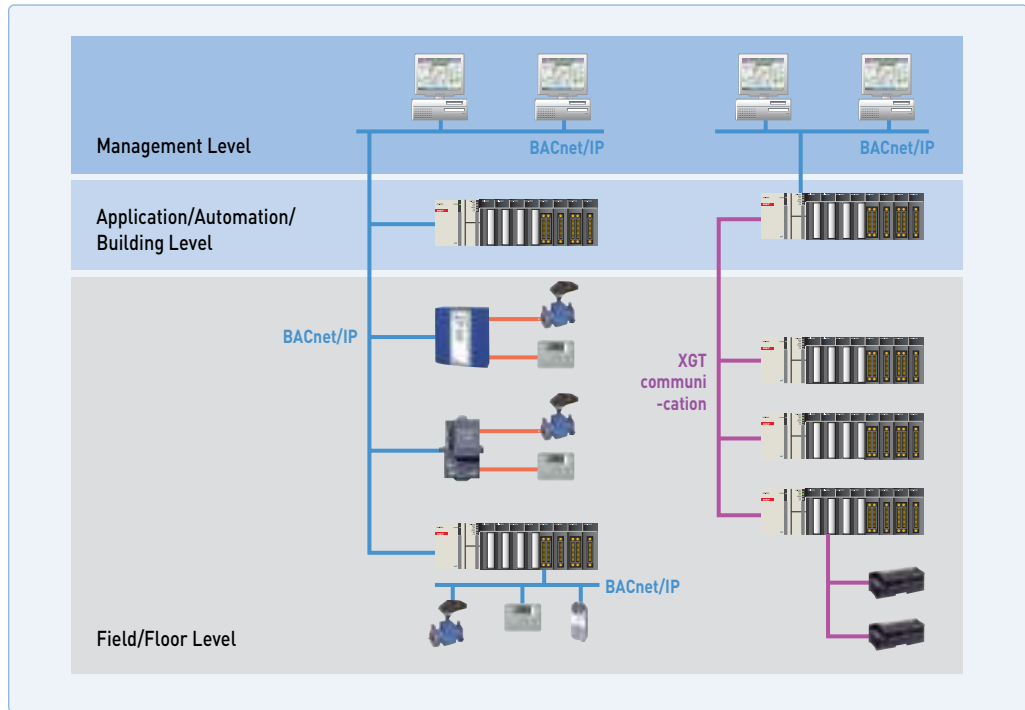

Device Profile	B-ASC + Client
Data Sharing	DS-RP-A, B DS-RPM-A, B DS-P-A, B DS-WPM-A, B
Device & Network Management	DM-DDB-B DM-DOB-B DM-DCC-A, B

## Specifications

Item		Specification
Transmission standards	Transmission speed	100Mbps
	Transmission method	Base hand
	Maximum extension distance between nodes	100m
	Maximum size of protocol	1,536 bytes
	Communication access method	CSMA/CD
	Frame error check method	CRC 32 = $X^{32}+X^{28}+X^{25}+ \dots +X^2+X+1$
	Maximum number of units installed	24 units
Service	Service type	P2P/Server
	Maximum communication data	1,400 bytes
	Support object(Server)	Device Object Binary Input Object Binary Output Object Analog Input Object Analog Output Object
	Diagnostic function	Communication module information Service status information Media information Ping test Auto scan DCC(Device Communication Control) System log
Basic standards	External dimensions(mm)	90(H) × 27(W) × 90(D)
	Current consumption(mA)	400
	Weight(g)	102



## Communication among PLCs

This is a system configuration communicating between XGT PLCs by serial communication. In this case, PLC 1 is the master (Client) and other PLC should be slaves (Server). It is called Master/Slave communication. Master PLC is defined by comm. basic parameter and P2P setting. And slave PLC is defined by basic parameter and driver setting.

## Configuration

PLC1 reads present value, C0000 of PLC 2's up-counter and then saves it in M0200 of PLC1.

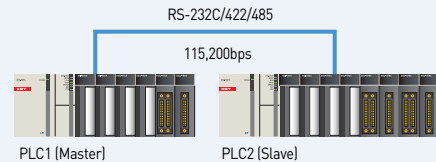

## Data memory

PLC station	PLC memory	Setting Item
PLC 1	M0100	1. XG5000 parameter setting, 2. XG5000 programming
PLC 2	C0000	1. XG5000 parameter setting, 2. XG5000 programming

## XG5000 setting

### PLC setting 1 (Master)



**Communication basic parameter setting**  
Setting up station number, communication speed, etc. And setting up the operation mode as P2P



**P2P channel setting**  
Setting up channel 01 as [XGT client]



**P2P setting**  
Setting up P2P block (READ)



**Enable Link**  
Enabling P2P for communication start



**Parameter writing**  
Downloading parameters to PLC after online connection



**Communication data setting**  
Setting up Read area, Save area, etc.

### PLC setting 2 (Slave)

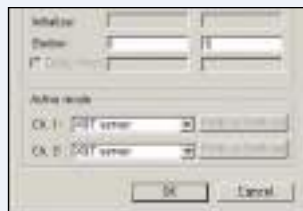

**Communication parameter setting**  
Setting up station number and channel 01 mode as 1 and XGT server



**Parameter writing**  
Downloading parameters to PLC after online connection

\* For basic parameter setting and SyCon setting/change, reset the module (Online reset).

## XG5000 programming

### PLC station 2 setting

Make up-counter program using CTU command

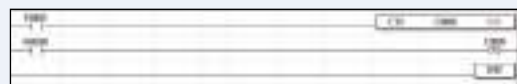

### PLC station 1 setting

Check out the counter value of M0100 is transmitted.

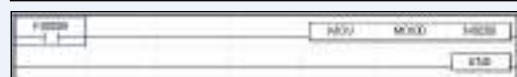



## HMI communication configuration

This is a system configuration to monitor and control PLC (XGT) by XP (HMI). In this case, PLC is the slave (Server) and XP should be the master (Client). PLC is defined by comm. basic parameter and driver setting.

### configuration

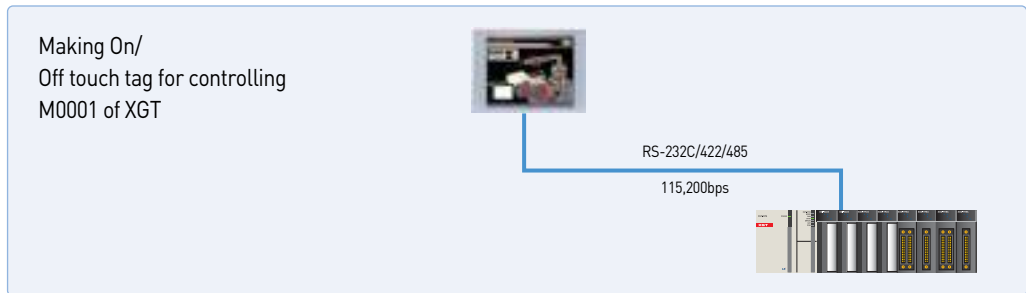

## Data memory

PLC memory	Setting item	PMU
M0001	1. XG5000 parameter setting	Using touch tag
	2. XG5000 programming	

## XG5000 setting

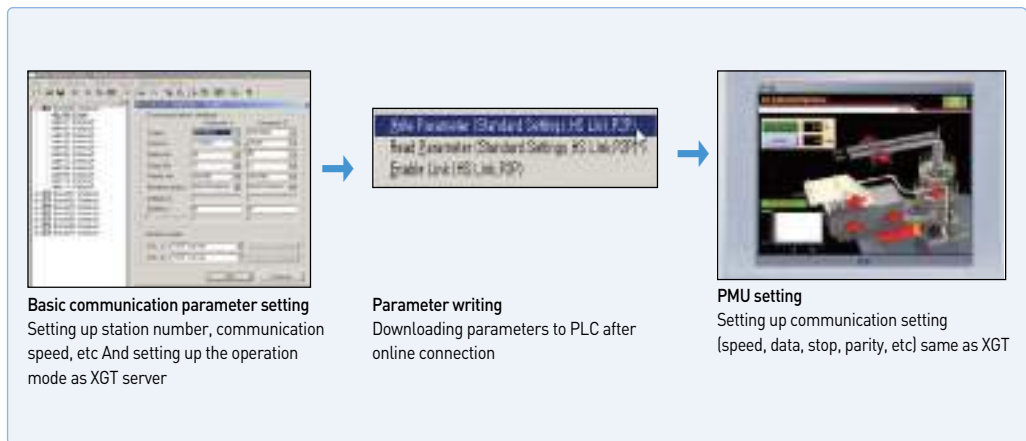

NETWORK

## XG5000 programming

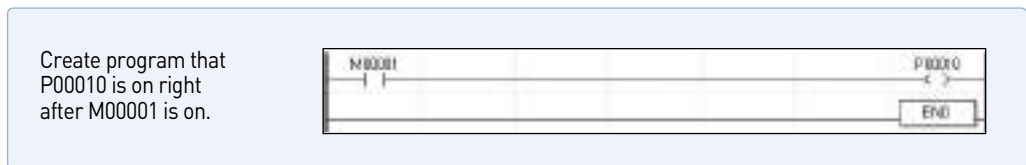

## HMI communication configuration

This is a data communication system configuration among XGT PLCs via Ethernet network. In this case, communication is possible by HS link among PLCs. It just needs basic parameter setting and HS link item setting.

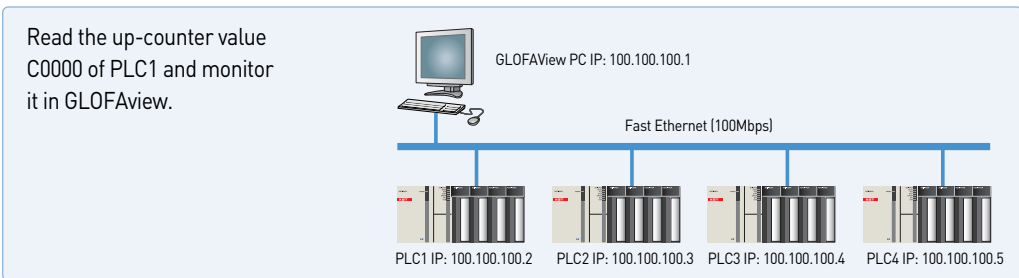

## Data memory

PLC station	Setting item	GLOFAView
C0000	1. XG5000 parameter setting	Using analog tag
	2. XG5000 programming	

## XG5000 setting

**PLC setting 1 (Master)**

**Basic communication parameter setting**  
Specifying IP address and Subnet mask of PLC as above

**Parameter writing**  
Downloading parameters to PLC after online connection

**Communication test**  
Checking online and system diagnosis

**System Diagnosis**  
Selecting Ping Test

**Ping Test**  
Starting diagnosis after inputting IP address of PLC

\* For basic parameter setting and SyCon setting/change, reset the module (Online reset).

## XG5000 programming

Make the up-counter program using CTU command. Check out if the counter value of CTU value is transmitted.

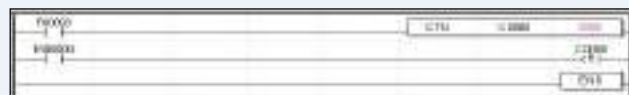

## High-speed link communication configuration

This is a configuration for XGT to communicate each other via Ethernet. It just needs communication basic parameter setting and High-speed link item setting.

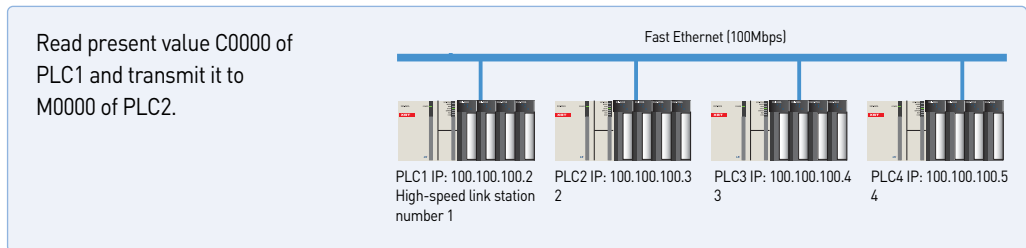

## Data memory

PLC station	PLC memory	Setting Item
PLC 1	C0000	1. XG5000 parameter setting, 2. XG5000 programming
PLC 2	M0100	1. XG5000 parameter setting, 2. XG5000 programming

## XG5000 setting

### PLC station 1 (setting)

**Basic communication parameter setting**  
Specifying HS link station, IP address and Subnet mask of PLC as above

**Communication data setting**  
Setting up communication data in HS link item as above

**Parameter writing**  
Downloading parameters to PLC after online connection

**Enable Link**  
Enabling link for communication start

### PLC station 2 (setting)

**Basic communication parameter setting**  
Specifying HS link station, IP address and Subnet mask of PLC as above

**Communication data setting**  
Setting up communication data in HS link item as above

**Parameter writing**  
Downloading parameters to PLC after online connection

**Enable Link**  
Enabling link for communication start

\* For basic parameter setting and SyCon setting/change, reset the module (Online reset).



## XG5000 programming

**PLC1 setting**  
Make the up-counter program using CTU command

**PLC2 setting**  
Check out if the counter value of M0100 is transmitted.

# Communication example (Rnet)

## Remote I/O configuration

LSIS developed communication method is Rnet which is 'Distributed Control System' using Smart I/O. In this case, PLC is the master and the other Smart I/O are slaves. It just needs basic parameter setting for communication and High-speed link setting.

## configuration

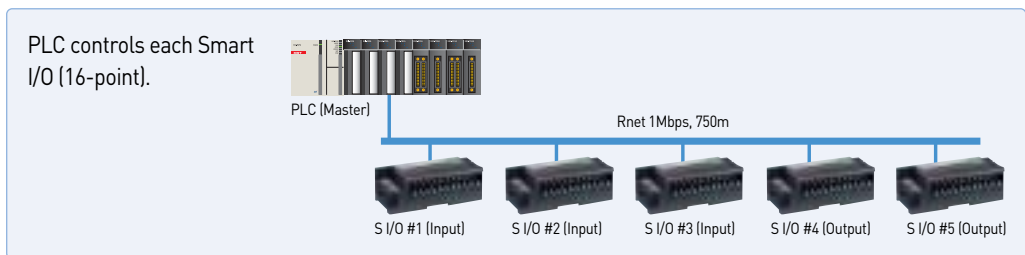

## Data memory

Smart I/O #	Smart I/O address	PLC address	Setting item
1	P0000	P0010 (P00100~P0010F)	1. XG5000 parameter setting, 2. XG5000 programming
2	P0000	P0011 (P00110~P0011F)	
3	P0000	P0012 (P00120~P0012F)	
4	P0000	P0013 (P00130~P0013F)	
5	P0000	P0014 (P00140~P0014F)	

## XG5000 setting

### Communication data setting

Setting up type name, station number, address of each station's Smart I/O in HS link item as following example.

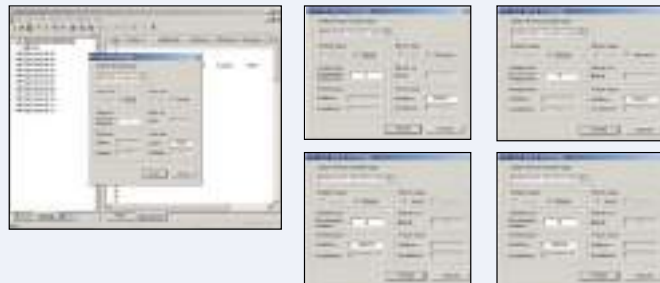

HS link registration completed



Parameter writing  
Downloading parameters to PLC after online connection



Enable Link  
Enabling link for communication start

\* For basic parameter setting and SyCon setting/change, reset the module (Online reset).

## XG5000 programming

Write a program using I/O address of Smart I/O.

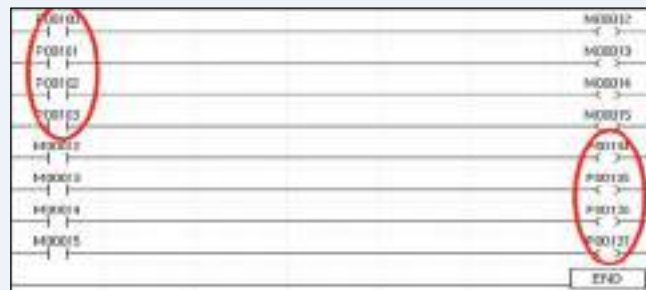

## High-speed link communication among PLCs

XGT can create 'Distributed Control System' with Smart I/O, Inverter, pneumatic device via Profibus-DP. In this case, PLC is the master and the other devices such as Smart I/O are slaves. It just needs SyCon, basic parameter and High-speed link setting.

### configuration

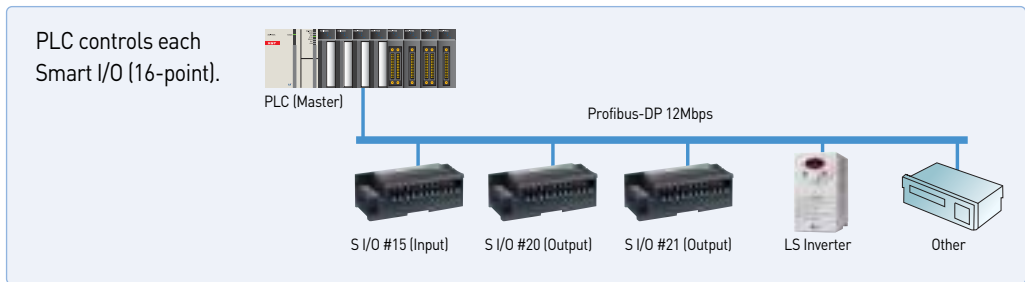

### Data memory

Smart I/O #	Smart I/O address	PLC address	Setting item
15	P0000	P0010 (P00100-P0010F)	1. SyCon setting 2. XG5000 parameter setting, 3. XG5000 programming
20	P0000	P0011 (P00110-P0011F)	
21	P0000	P0012 (P00120-P0012F)	

### XG5000 setting

**SyCon setting**  
For detailed setting instruction, refer to page 43 (SyCon setting)

**HS link setting**  
Uploading SyCon and setting up each Smart I/O station as following example

**Parameter writing**  
Downloading parameters to PLC after online connection

**Enable Link**  
Enabling link for communication start

**NETWORK**

\* For basic parameter setting and SyCon setting/change, reset the module (Online reset).

### XG5000 programming

Write a program using I/O address of Smart I/O Pnet

The screenshot shows a ladder logic diagram with several rungs. The addresses for the Smart I/O Pnet are highlighted with red circles: P0010, P0011, P0012, P0013, P0014, P0015, P0016, P0017, P0018, P0019, P0020, P0021, P0022, P0023, and P0024. The diagram ends with an END instruction.

## High-speed link communication among PLCs

XGT can create 'Distributed Control System' with Smart I/O, Inverter, pneumatic device via Dnet. In this case, PLC is the master and the other devices such as Smart I/O are Slaves. It just needs SyCon, basic parameter and High-speed link setting.

## configuration

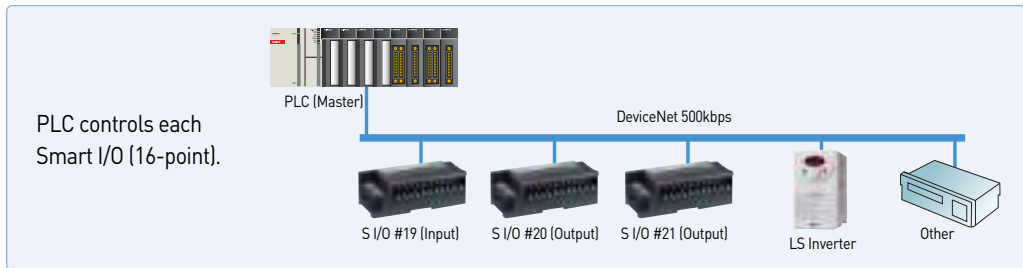

## Data memory

Smart I/O #	Smart I/O address	PLC address	Setting item
19	P0000	P0010 (P00100~P0010F)	1. SyCon setting 2. XG5000 parameter setting, 3. XG5000 programming
20	P0000	P0011 (P00110~P0011F)	
21	P0000	P0012 (P00120~P0012F)	

## XG5000 setting

**SyCon setting**  
For detailed setting instruction, refer to page 43 (SyCon setting)

**HS link setting**  
Uploading SyCon and setting up each Smart I/O station as following example

**Parameter writing**  
Downloading parameters to PLC after online connection

**Enable Link**  
Enabling link for communication start

\* For basic parameter setting and SyCon setting/change, reset the module (Online reset).

## XG5000 programming

Write a program using I/O address of Smart I/O Dent.

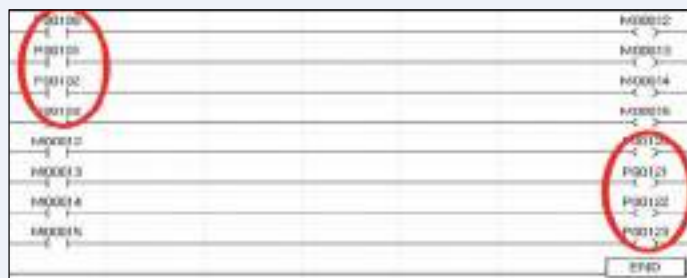

SyCon is the dedicated software that help user set up the communication environment for Profibus-DP and DeviceNet more easily and conveniently.

## Example of application

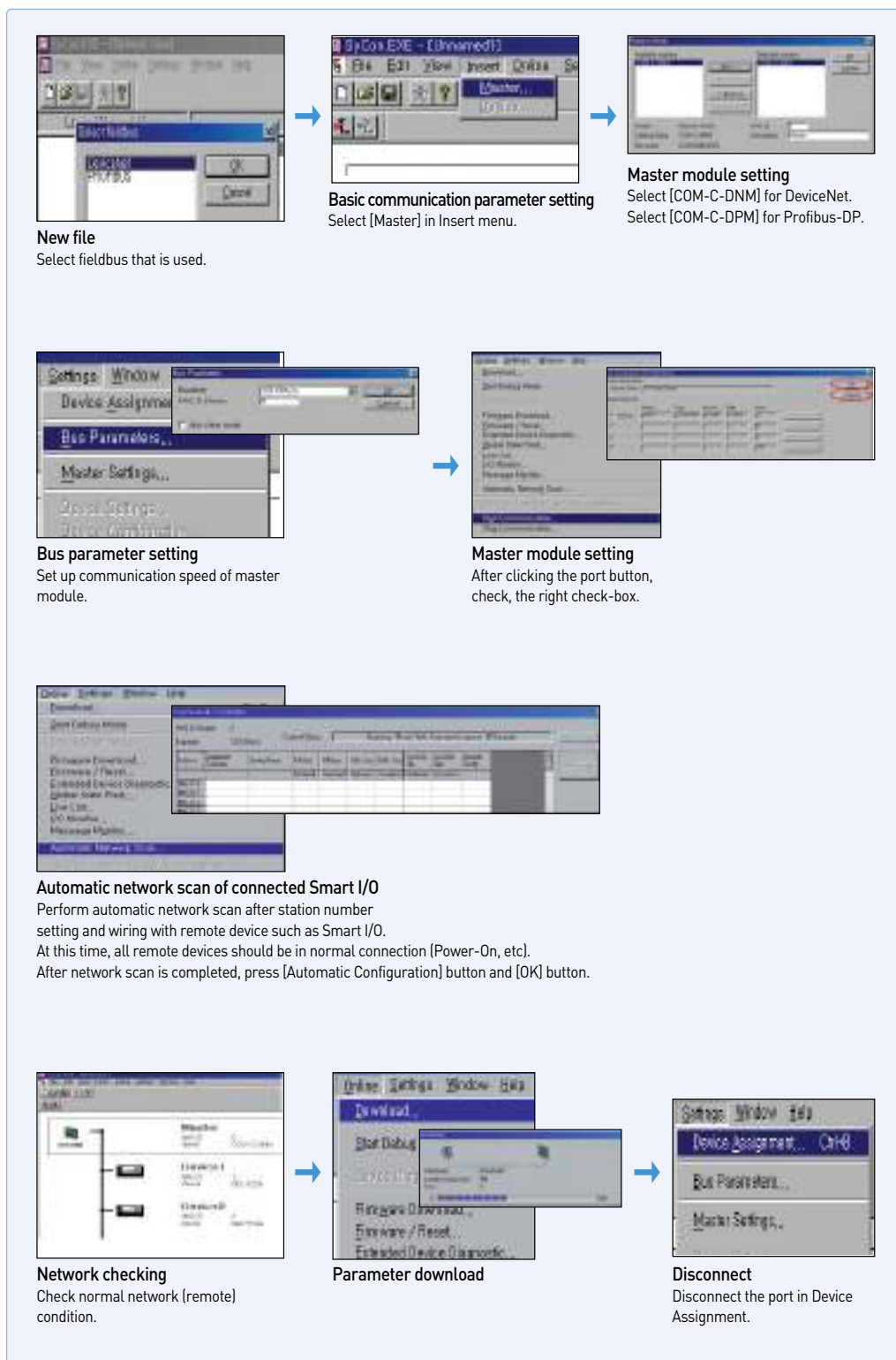

## Features

- Wiring reduction and real time control of distributed I/O
- Supporting Rnet, DeviceNet, Profibus-DP, Modbus (RS-422/485), RAPIEnet
- Various I/O (DC/TR/Relay) modules with the unit of 16/32 points



## Digital I/O specifications

Item	Input		Output			Mixed module	
	DC (Sink/Source)		Transistor (Sink)	Relay	DC (Sink/Source)	Transistor (Sink)	
No. of point	16	32	16	32	16	16	
Rated input (Load voltage)	DC 24 V		DC 24 V		DC 24 V/AC 110 V/220 V		
Input current (Load current)	7 mA		0.1 A/2 A, 0.5 A/3 A		2 A/5 A		
Response time	Off →On	3 ms or less	3 ms or less	3 ms or less	3 ms or less	3 ms or less	
	On →Off	3 ms or less	3 ms or less	3 ms or less	3 ms or less	3 ms or less	
Common	16 points/COM		16 points/COM		16 points/COM		
Current consumption	200 mA	300 mA	280 mA	380 mA	550 mA	350 mA	
Network	Rnet	GRL-D22C	GRL-D24C	GRL-TR2C1	GRL-TR4C1	GRL-RY2C	GRL-DT4C1
	Profibus-DP	GPL-D22C	GPL-D24C	GPL-TR2C/TR2C1	GPL-TR4C/TR4C1	GPL-RY2C	GPL-DT4C/DT4C1
	DeviceNet	GDL-D22C	GDL-D24C	GDL-TR2C/TR2C1	GDL-TR4C/TR4C1	GDL-RY2C	GDL-DT4C/DT4C1
	Modbus	GSL-D22C	GSL-D24C	GSL-TR2C1	GSL-TR4C1	GSL-RY2C	GSL-DT4C1
RAPIEnet	-	GEL-D24C	-	GEL-TR4C1	GEL-RY2C	-	GEL-DT4C1

Note1) C Source, Rated current: 0.5A, terminal separated type  
C1 Sink, Rated current: 0.5A terminal separated type

## Analog I/O specifications

Item	GPL-AV8C/GEL-AV8C	GPL-AC8C/GEL-AC8C	Item	GPL-DV4C/GEL-DV4C	GPL-DC4C/GEL-DC4C
Input channels	8 channels		Output channels	4 channels	
Analog input	DC 1-5 V, 0-5 V, 0-10 V,	0-20 mA, 4-20 mA,	Digital input	0-4000, 0-8000, -8000-8000	0-8000
	-10~+10 V	-20-20 mA		DC 1-5 V, 0-5 V, 0-10 V,	0-20 mA, 4-20 mA
Digital output	0-4000, 0-8000, -8000-8000	0-4000, -8000-8000	Analog output	-10~+10 V	
Input impedance	1 M $\Omega$	250 $\Omega$		Load impedance	1 K $\Omega$ or more (0-5 V or 1-5 V) 2 K $\Omega$ or more (0-10 V or -10-10 V)
Max. resolution	$\pm 15$ V	$\pm 30$ mA	Resolution	1.25 mV	2.5 $\mu$ A
	1.25 mV	2.5 $\mu$ A		Accuracy	$\pm 0.3%$ (full scale, Ta=0-55 °C)
Accuracy	$\pm 0.3%$ (full scale, Ta=0-55 °C)	$\pm 0.3%$ (full scale, Ta=23 °C $\pm 5$ °C)	Accuracy	$\pm 0.3%$ (full scale, Ta=0-55 °C)	$\pm 0.4%$ (full scale, Ta=0-55 °C)
		$\pm 0.4%$ (full scale, Ta=0-55 °C)		Conversion speed	10 ms or less/4 channel
Conversion speed	10 ms or less/8 channel		Response period	10 ms or less/8 channels + Transmission period (ms)	
Response period	10 ms or less/8 channels + Transmission period (ms)			Analog input/output terminal with FG →Insulation	
Insulation method	Analog input/output terminal with Communication terminal →Insulation		Insulation method	Analog input/output terminal with Communication terminal →Insulation	
	Analog input/output terminal with each channel →No insulation			Analog input/output terminal with each channel →No insulation	
External power supply	DC 24 V (21.6 ~ 26.4)		External power supply	insulation DC 24 V (20.4 ~ 28.8)	
External current consumption	DC 24 V : 220 mA		External current consumption	210 mA	240 mA
Weight (kg)	0.313	0.313	Weight (kg)	0.314	0.322

## Communication specifications

Item	Rnet (LS dedicated network)	Profibus-DP	DeviceNet	MODBUS	RAPIEnet(RJ-45)
Protocol	LSIS dedicated protocol (Fnet for Remote)	Profibus-DP (RS-485/EN50170)	DeviceNet (CAN)	MODBUS (RS-422/485)	Fast Ethernet
Transmission speed	1 Mbps	9.6 Kbps ~ 12 Mbps	125/250/500 Kbps	2.4 Kbps ~ 38.4 Kbps	100Mbps
Transmission distance	750 m/segment	100 m ~ 1.2 km	500/250/125 m (Thin cable: 100 m)	500 m	100M
Topology	Bus Token	Bus	Trunk & Drop	Bus	CRC32
Transmission	Pass & Broadcast	Token Pass & Master/Slave (Poll)	CSMA/NBA (Poll, Cyclic, COS, Bit Strobe)	Master/Slave (Poll)	CSMA/CD
No. of stations	32/segment (Input: 32, Output: 32)	32/segment, 99/network	64	32	64



# (Modbus TCP/IP, Ether Net/IP Adapter) 80 / 81

## Features

- IEEE 802.3 standard
- Modbus TCP/IP, EtherNet/IP
- 10/100BASE-TX media
- Ethernet Twisted pair 2ports (RJ-45)
- 2channels Ethernet MAC
- Auto-Negotiation/Auto-Crossover
- Various system configuration



## Specification

Items		XEL-BSSA	XEL-BSSB
I/F	Protocol	Modbus TCP	EtherNet/ IP
	Transmission speed	10 /100Mbps	
	Connector	RJ-45(2ports)	
	Topology	Software(BootpServer)	
	IP setup	Bus, Star	
Max. expansion module		8ea	
Max. digital I/O point		256 points	
Max. analog I/O channel		32ch (Input 16ch, Output 16ch)	
Operating power	Rated voltage	DC 24V	
	Range	DC19.2 ~ 28.8V	
	Rated current	1.5A	
	Insulation	Non-Insulation, Comm. Part insulation	

## System configuration

Items	Description	Max. I/O point	
Digital I/O	XBE-DC08A	DC24V input 8pt	Max. 256 points
	XBE-DC16A	DC24V input 16pt	
	XBE-DC32A	DC24V input 32pt	
	XBE-RY08A	Relay output 8pt	
	XBE-RY16A	Relay output 16pt	Max. 256 points
	XBE-TN08A	Tr output 8pt, Sink	
	XBE-TP08A	Tr output 8pt, Source	
	XBE-TN16A	Tr output 16pt, Sink	
	XBE-TP16A	Tr output 16pt, Source	
	XBE-TN32A	Tr output 32pt, Sink	
	XBE-TP32A	Tr output 32pt, Source	
	XBE-DN16A	DC24V input 8pt, Tr output 8pt	
Analog, Temperature	XBF-AD04A	Current/Voltage input 4Ch	Input Max. 16ch Output Max. 16ch
	XBF-AD04C	4-channel analog input (current / voltage, resolution : 1/16000)	
	XBF-DC04A	Current output 4Ch	
	XBF-DV04C	4-channel analog input (voltage, resolution : 1/16000)	
	XBF-DV04A	Voltage output 4Ch	
	XBF-DV04C	4-channel analog input (voltage, resolution : 1/16000)	
	XBF-RD04A	RTD input 4Ch	
XBF-TC04S	TC input 4Ch		

\* When Digital input and Analog input is used together or Digital output Analog output is used, configure the system within 32bytes  
 (Ex) If 4ch analog input is used, Digital input can be used max. 192points

## Externals and inscriptions

Item	LED status
RUN	Operation status
	On: Normal operation Off: Abnormal operation
I/O ERROR	Interface status of expansion module
	On: Expansion module error Off: Normal operation
TX	Data send status to master
	On: Under transmission Off: No data
RX	Data receive status from master
	On: Under receiving Off: No data

## Dimension

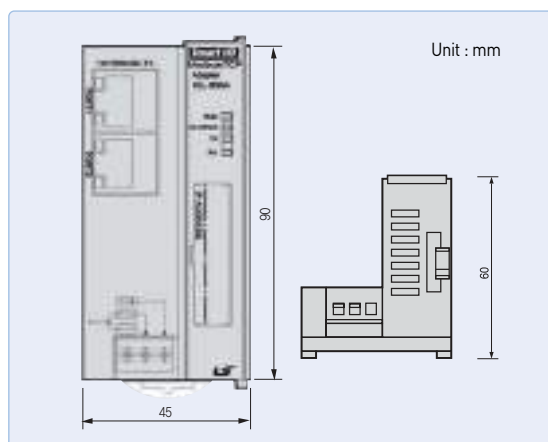

## Features

- Max. 63 stations
- Flexible connection via DeviceNet
- Utilize same I/O modules with XGB
  - Max. 512 I/O points
  - Max. 32 channels analog input/output



## Specification

Items		Description		
Communication Specification		Poll, Bit-strobe, COS/Cyclic		
		Group 2 only slave		
		Auto baud rate		
Module's Type		Slave		
Max. Node Number [MAC ID]		64[0-63]		
Number of Expansion I/O Slots		8		
Max. DC I/O Data Size		Input:32bytes / Output:32bytes		
Max. Analog Channels		Input : 16Channels / Output : 16Channels		
Speed & Distance	Comm. Speed	125 kbps	250 kbps	500 kbps
	Distance	500 m	250 m	100 m
Input Power	System Power	DC 24V		
	Range	19.2V ~ 28.8V(11V operate)		
	Output Voltage/Current	5V(±20%) /1.5A		
Weight[g]		100		

\* When I/O module is installed, check the current consumption  
(Max. Current: 1.5A)

## System configuration

Items		Description	Max. I/O point
Digital I/O	XBE-DC08A	DC24V input 8pt	256points
	XBE-DC16A	DC24V input 16pt	
	XBE-DC32A	DC24V input 32pt	
	XBE-RY08A	Relay output 8pt	
	XBE-RY16A	Relay output 16pt	
	XBE-TN08A	Tr output 8pt, Sink	
	XBE-TP08A	Tr output 8pt, Source	
	XBE-TN16A	Tr output 16pt, Sink	
	XBE-TP16A	Tr output 16pt, Source	
	XBE-TN32A	Tr output 32pt, Sink	
	XBE-TP32A	Tr output 32pt, Source	
	XBE-DN16A	DC24V input 8pt, Tr output 8pt	
Analog, Temperature	XBF-AD04A	Current/Voltage input 4Ch	16channels
	XBF-AD04C	4-channel analog input (current / voltage, resolution : 1/16000)	
	XBF-DC04A	Current output 4Ch	
	XBF-DV04C	4-channel analog input (voltage, resolution : 1/16000)	
	XBF-DV04A	Voltage output 4Ch	
	XBF-DV04C	4-channel analog input (voltage, resolution : 1/16000)	
	XBF-RD04A	RTD input 4Ch	
XBF-TC04S	TC input 4Ch		

\* When Digital input and Analog input is used together or Digital output Analog output is used, configure the system within 32bytes  
(Ex) If 4ch analog input is used, Digital input can be used max. 192points

## Externals and inscriptions

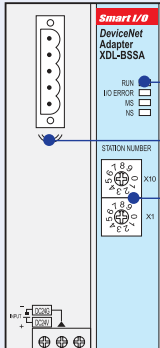

XDL-BSSA LED

DeviceNet port

Station switch

Item	LED status
RUN	ON : Normal
	OFF : Module error
I/O ERROR	ON : I/O module error
	OFF : Normal
MS	Green ON: Normal
	Green blink: Normal
	Red ON: Module error
NS	Green ON: Normal
	Green blink: Waiting
	Green off: Comm. stop
	Red ON: Network error
	Red blink: Disconnect

## Dimension

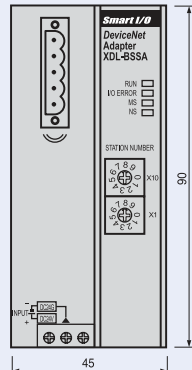

Unit : mm

90

45

80

# SMART I/O (Profibus-DP adapter)

## Features

- Max. 100 stations (32stations per segment)
- Flexible connection via Profibus
- Utilize same I/O modules with XGB
  - Max. 512 I/O points
  - Max. 32 channels analog input/output



## Specification

Item		Performance Specification					
Transmission	Standard	EN50170 / DIN 19245					
	Interface	RS-485(Electric)					
	Media Access	Polling					
	Topology	BUS					
	Encoding Method	NRZ					
	Interface	Sync mode , Freeze mode Auto baud rate					
	Master/Slave	Slave					
	Cable Type	Twisted Pair Shielded Cable					
	Comm. Distance	Kbps	9.6	19.2	93.75	187.5	500
			m	1200	1200	1200	1000
		kbps	1500	3000	6000	12000	-
			m	200	100	100	100
	Max. Node Number	100 ( 0 ~ 99 )					
Number of Expansion I/O Slots	8						
IO Data Size	64bytes (Input:32bytes/Output:32bytes)						
Number of Analog Channels	32Channels (Input : 16Channels/Output :16Channels)						
Input Power	System Power	Supply Voltage : DC 24Vdc 19.2 ~ 28.8Vdc					
	Output Voltage/Current	5V( ± 20% ) / 1.5A					
Weight(g)	100						

\* When I/O module is installed, check the current consumption (Max. Current: 1.5A)

## System configuration

Items	Description	Max. I/O point	
Digital I/O	XBE-DC08A	DC24V input 8pt	256points
	XBE-DC16A	DC24V input 16pt	
	XBE-DC32A	DC24V input 32pt	
	XBE-RY08A	Relay output 8pt	
	XBE-RY16A	Relay output 16pt	
	XBE-TN08A	Tr output 8pt, Sink	
	XBE-TP08A	Tr output 8pt, Source	
	XBE-TN16A	Tr output 16pt, Sink	
	XBE-TP16A	Tr output 16pt, Source	
	XBE-TN32A	Tr output 32pt, Sink	
	XBE-TP32A	Tr output 32pt, Source	
	XBE-DN16A	DC24V input 8pt , Tr output 8pt	
Analog, Temperature	XBF-AD04A	Current/Voltage input 4Ch	16channels
	XBF-AD04C	4-channel analog input (current/ voltage, resolution : 1/16000)	
	XBF-DC04A	Current output 4Ch	
	XBF-DV04C	4-channel analog input (voltage, resolution : 1/16000)	
	XBF-DV04A	Voltage output 4Ch	
	XBF-DV04C	4-channel analog input (voltage, resolution : 1/16000)	
	XBF-RD04A	RTD input 4Ch	
	XBF-TC04S	TC input 4Ch	

\* When Digital input and Analog input is used together or Digital output Analog output is used, configure the system within 32bytes  
(Ex) If 4ch analog input is used, Digital input can be used max. 192points

## Externals and inscriptions

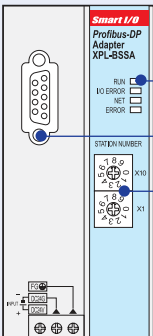

XDL-BSSA LED

Profibus-DP port

Station switch

Item	LED status
RUN	ON : Normal
	Blink: Waiting or comm. error
	OFF : Module error
I/O ERROR	ON : I/O module error OFF : Normal
NET	ON : Data send/receive OFF : Disconnection
ERROR	ON : Comm. error
	OFF : Normal

## Dimension

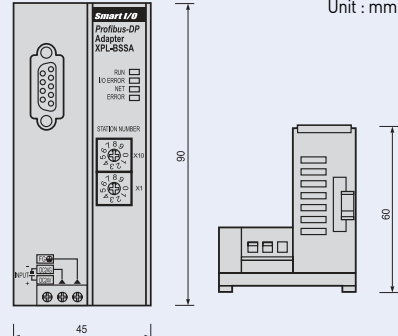

Unit : mm

## Features

- Max. 63 stations
- LS dedicated protocol (Rnet)
- Utilize same I/O modules with XGB
  - Max. 512 I/O points
  - Max. 32 channels analog input/output



## Specification

Item	Performance Specification	
Transmission	Tran. Rate	1Mbps
	Transmission Path	Bus type
	Method	750m
	Max. Cable Length	5 pin connector
	Connector type	Twisted Pair Shielded Cable
	Cable type	32(non-used repeater),
	No. of Station	64(used repeater)
	(Included Master)	512(Input : 256, Output: 256)
	Max. Digital I/O points	96
	Max. Analog I/O points	Digital I/O 8
	Number of I/O Slots	Analog I/O 4
	Selection of Latch/Clear	handling of mode change switch
Rated Voltage/current	DC24V/0.55A	
Weight (g)	100	

\* When I/O module is installed, check the current consumption  
[Max. Current: 1.5A]

## System configuration

Items	Description	Max. I/O point	
Digital I/O	XBE-DC08A	DC24V input 8pt	256points
	XBE-DC16A	DC24V input 16pt	
	XBE-DC32A	DC24V input 32pt	
	XBE-RY08A	Relay output 8pt	
	XBE-RY16A	Relay output 16pt	
	XBE-TN08A	Tr output 8pt, Sink	
	XBE-TP08A	Tr output 8pt, Source	
	XBE-TN16A	Tr output 16pt, Sink	
	XBE-TP16A	Tr output 16pt, Source	
	XBE-TN32A	Tr output 32pt, Sink	
	XBE-TP32A	Tr output 32pt, Source	
	XBE-DN16A	DC24V input 8pt, Tr output 8pt	
	Analog, Temperature	XBF-AD04A	
XBF-AD04C		4-channel analog input (current /voltage, resolution : 1/16000)	
XBF-DC04A		Current output 4Ch	
XBF-DV04C		4-channel analog input (voltage, resolution : 1/16000)	
XBF-DV04A		Voltage output 4Ch	
XBF-DV04C		4-channel analog input (voltage, resolution : 1/16000)	
XBF-RD04A		RTD input 4Ch	
XBF-TC04S		TC input 4Ch	

\* When Digital input and Analog input is used together or Digital output Analog output is used, configure the system within 32bytes  
(Ex) If 4ch analog input is used, Digital input can be used max. 192points.

## Externals and inscriptions

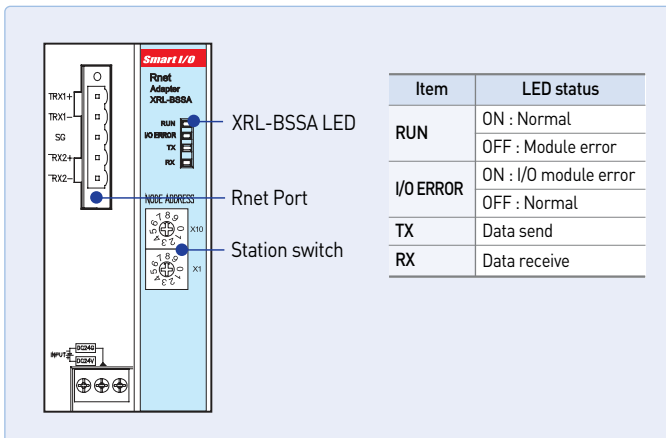

## Dimension

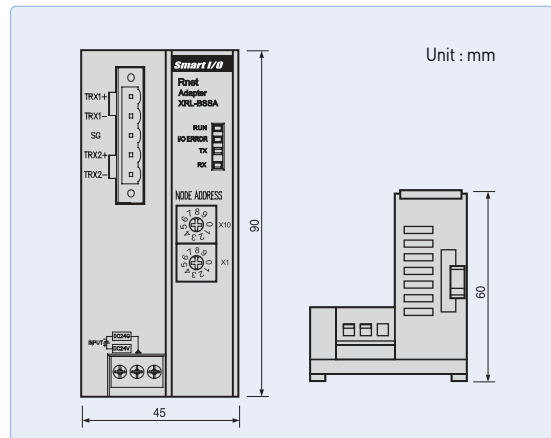

# SMART I/O (Features)

## Smart I/O Rnet system

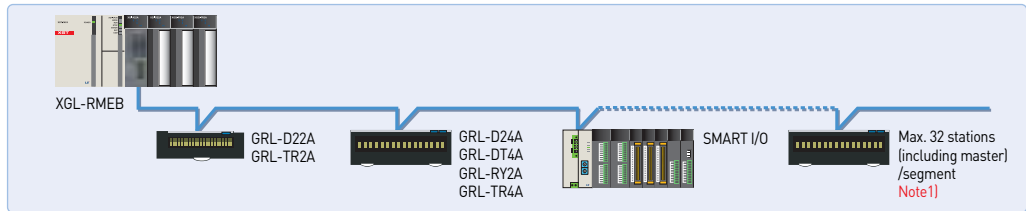

## Smart I/O Modbus system

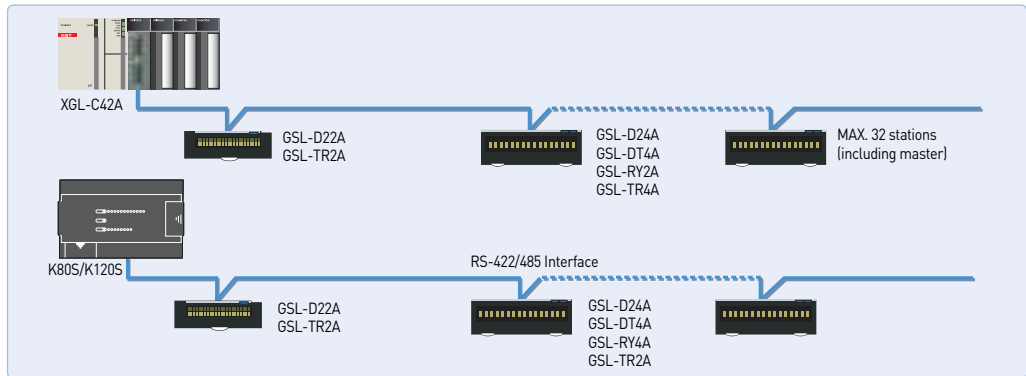

## Smart I/O Profibus-DP system

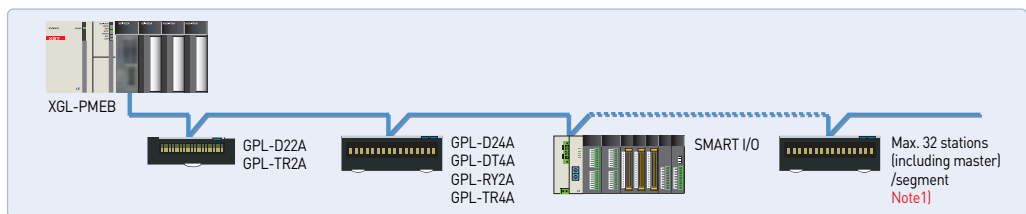

## Smart I/O DeviceNet system

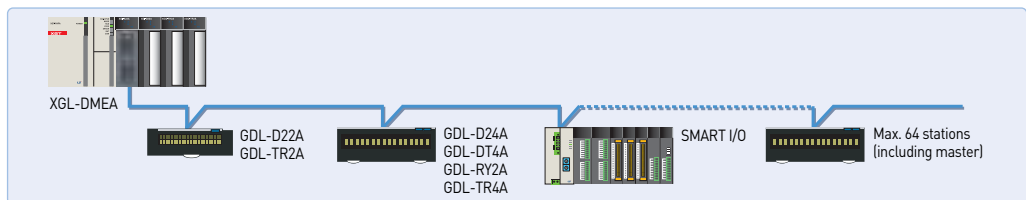

**Note1)** Segment: Communication section that does not use repeater or second master.

## Dimensions

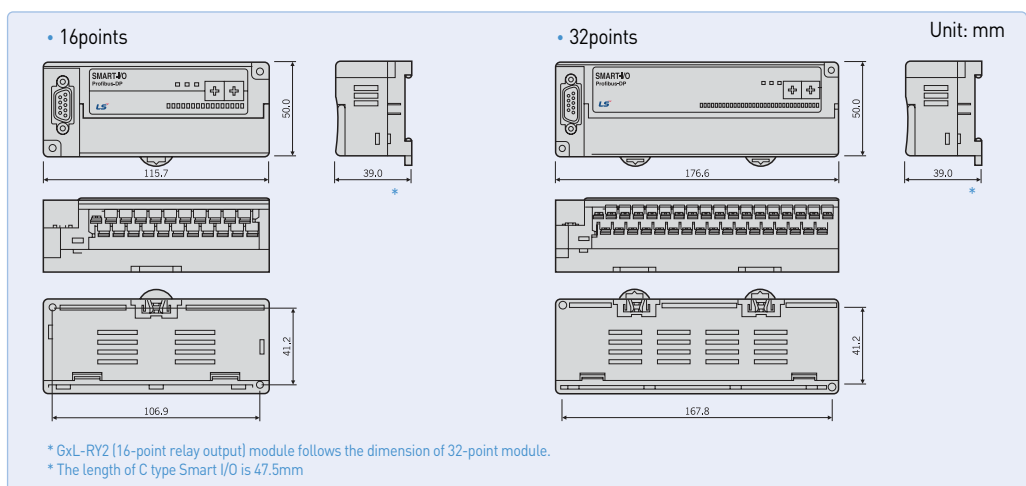

## Network Standard

Item	Rnet (LS dedicated network)	Profibus-DP	DeviceNet	MODBUS	RAPINet (RJ-45)
Protocol	LSIS dedicated protocol (Fnet for Remote)	Profibus-DP (RS-485/EN50170)	DeviceNet (CAN)	MODBUS (RS-422/485)	Fast Ethernet
Transmission speed	1 Mbps	9.6 Kbps ~ 12 Mbps	125/250/500 Kbps	2.4 Kbps ~ 38.4 Kbps	100Mbps
Transmission distance	750 m/segment	100 m ~ 1.2 km	500/250/125 m (Thin cable: 100 m)	500 m	100M
Topology	Bus Token	Bus	Trunk & Drop	Bus	CRC32
Transmission	Pass & Broadcast	Token Pass & Master/Slave (Poll)	CSMA/NBA (Poll, Cyclic, COS, Bit Strobe)	Token Pass & Master/Slave (Poll)	CSMA/CD
No. of stations	32/segment (Input: 32, Output: 32)	32/segment, 99/network	64	32	64

NETWORK





# Special

XGT series offer diverse special modules such as analog, HSC, and positioning to satisfy complicated industrial needs

## Contents

88	XGT special module
90	Analog input module
92	2Wire Analog input module
93	Analog input module [Isolated]
94	Analog input module [Example]
95	Analog output module
96	Analog output module [Example]
97	Analog input/output module
98	HART interface analogue/digital conversion module
99	High-speed counter module
102	8-Channel high speed counter module
103	High-speed counter module [Example]
106	Positioning module [APM]
108	Positioning module (XPM)
110	Positioning module (Network Type)
112	XG5000
113	Motion Module [EtherCAT]
114	RTD input module
115	Thermocouple module
116	Temperature controller
118	Event input module
119	Datalog module

## Revolution of easy to use ... XGT Special module

### Fast processing of parameter and data of special module

- Continually refreshing operation data of special module by CPU module
- Including contact points such as conversion data of AD/DA module and command of HSC & positioning module



### Easy- to-use(Easy operation parameter setting and data monitoring)

- Convenient parameter setting available through XG5000
- Providing useful functions that can monitor and test operation data and contact points through XG5000

### Simple maintenance (Changing online module)

- Without turning off and holding CPU, users can change special module with ease.

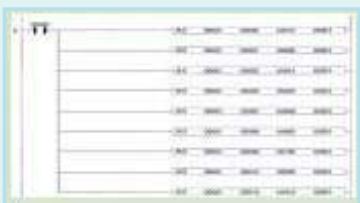
Before

Example of programming

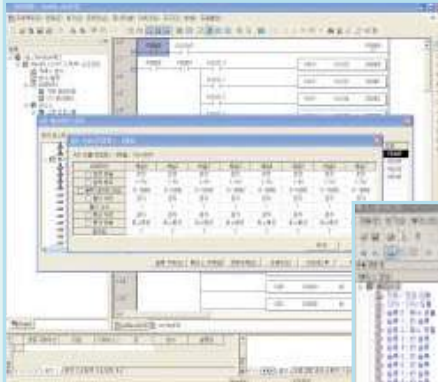

Monitoring of special module



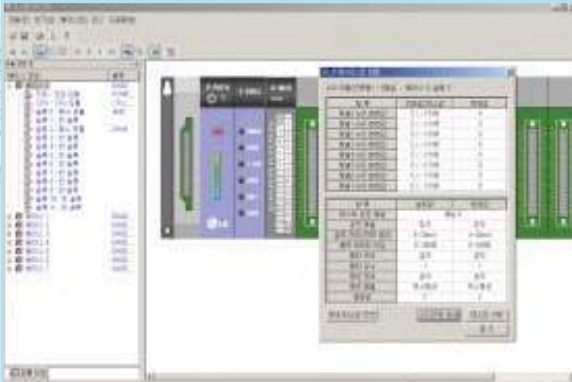

## Analog input/output module



### Analog input module

XGF-AV8A	8 channels, voltage
XGF-AC8A	8 channels, current
XGF-AD8A	8 channels, voltage/current
XGF-AD4S	4 channels, voltage/current
XGF-AD16A	16 channels, voltage/current
XGF-AW4S	2-wire, Voltage/ Current input, 4Ch (Isolated)



### Analog output module

XGF-DV4A	4 channels, voltage
XGF-DC4A	4 channels, current
XGF-DV8A	8 channels, voltage
XGF-DC8A	8 channels, current
XGF-DV4S	4 channels, voltage, Isolated
XGF-DC4S	4 channels, current, Isolated

### Analog input/output module

XGF-AH6A	Input: 4ch, Voltage/ Current Output: 2Ch Voltage/ Current
----------	--

## Temperature module



### Temperature input module

XGF-TC4S	4 channels, thermocouple input, Isolated
XGF-RD4A	4 channels, RTD input
XGF-RD4S	4 channels, RTD input, Isolated



### Temperature controller

XGF-RD8A	8 channels input: RTD
XGF-TC4UD	4 channels input: voltage/current/TC/RTD 8 channels output: current/TR
XGF-TC4RT	4 channels input: RTD 4 channels output: TR Control: 4loop

## Positioning module/Motion controller



### Positioning module

XGF-PO1A-PO3A	Open collector, 1~3axis
XGF-PD1A-PD3A	Line drive, 1~3axis
XGF-PO1H-PO4H	Open collector, 1~4axis
XGF-PD1H-PD4H	Line drive, 1~4axis

## Motion module



### Motion module

XGF-M32E	Standard EtherCAT Net, 32 axes
----------	--------------------------------

## High speed counter module



### High-speed counter module

XGF-H02A	2 channels, Open collector
XGF-HD2A	2 channels, Line driver
XGF-H08A	8-channels high speed counter module, 8Ch

## Event input module



### High-speed counter module

XGF-S0EA	DC24V, 32points
----------	-----------------



## Features

- Fast conversion processing
- High resolution
- Setting and monitoring the special module parameter through XG5000
- Supporting 4 types of digital output data format

## Specifications

Item	XGF-AV8A (Voltage input)	XGF-AC8A (Current input)	XGF-AD4S (Voltage/Current input)						
No. of input channel	8 channels		4 channels						
Analog input	DC 1-5V, 0-5V, 0-10V, -10-10V	DC 4-20mA, 0-20mA	DC 1-5V, 0-5V, 0-10V, -10-10V DC 4-20mA, 0-20mA						
Digital output	Selection of input range in program or S/W package (Available to be set per channel)								
	XGF-AV8A	Analog input		1-5V	0-5V	0-10V	-10-10V		
		Digital output	Unsigned value		0-16,000				
			Signed value		-8000-8,000				
			Precise value	1,000-5,000	0-5,000	0-10,000	-10,000-10,000		
	Percentile value		0-10,000						
	XGF-AC8A	Analog input		4-20mA		0-20mA			
		Digital output	Unsigned value		0-16,000				
			Signed value		-8,000-8,000				
			Precise value	4,000-20,000		0-20,000			
	Percentile value		0-10,000						
	XGF-AD4S	Analog input		1-5V	0-5V	0-10V	-10-10V	4-20mA	0-20mA
Digital output		Signed value		-32,000-32,000					
		Precise value	1,000-5,000	0-5,000	0-10,000	-10,000-10,000	4,000-20,000	0-20,000	
		Percentile value		0-10,000					
Resolution	1/16,000				1/64,000				
	1-5V	0.250mV	4-20mA	1.0μA	1-5V	62.5μV	4-20mA	250nA	
	0-5V	0.3125mV			0-5V	78.1μV			
	0-10V	0.625mV	0-20mA	1.25μA	0-10V	156.3μV	0-20mA	312.5nA	
-10V-10V	1.250mV	±10V			312.5μV				
Accuracy	±0.2% or less (Ambient temperature 25°C) ±0.3% or less (Range of operation temperature)				±0.05% or less (Ambient temperature 25°C) Temp. coefficient ±16.7ppm/°C (Range of operation temperature)				
Conversion speed	250μs/channel								
Max. absolute input	15V	±30mA		Voltage: ±15V, Current: ±30mA					
Insulation method	Photo-coupler Insulation between input terminal and power supply								
	No insulation between channels				Insulation between channels				
Connection terminal	18 points								
No. of occupied	Fixed type (Setting in basic parameter): 64 points								
I/O points	Variable type (Dissolving in basic parameter): 16 points								
Current consumption	420mA				610mA				
Weight [Kg]	0.14								

## Configuration

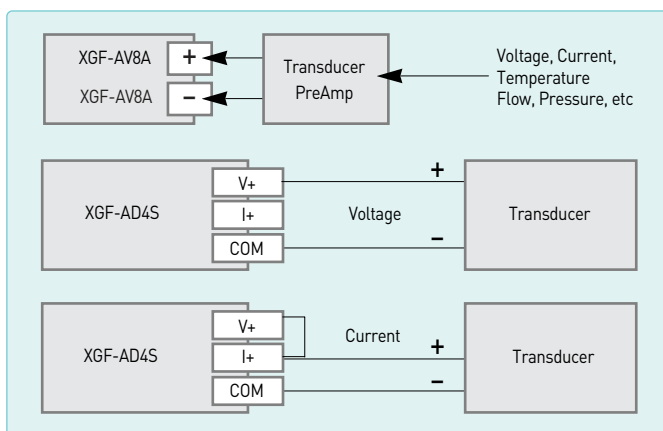

## A/D conversion characteristics

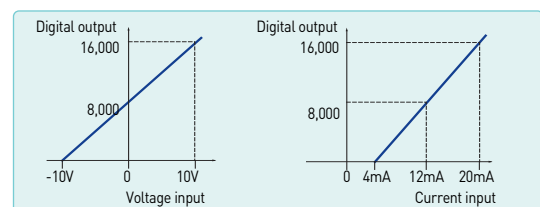

## Insulation type

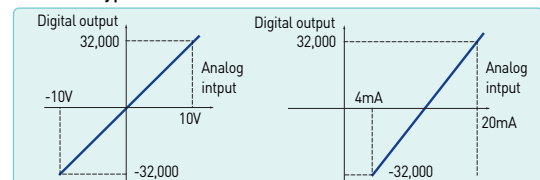



## Features

- Fast conversion processing
- High resolution
- Setting and monitoring the special module parameter through XG5000
- Supporting 4 types of digital output data format

## Specifications

Item	XGF-AD16A				XGF-AD8A	
No. of input channel	16 channels				8 channels	
Analog input	Voltage input					
	DC 1-5V, DC 0-5V, DC 0-10V, DC -10-10V (Input resistance: 1M $\Omega$ )					
	Current input					
	DC 4-20mA, DC 0-20mA (Input resistance: 250 $\Omega$ )					
	Dip switch					
Range selection	Selection of input range in the program or S / W package (Available to set per each channel)					
Input type	Voltage input				Current input	
	DC 1-5V	DC 0-5V	DC 0-10V	DC -10-10V	DC 4-20mA	DC 0-20mA
Digital output	Unsigned value					
	0-16,000					
	Signed value					
	-8,000-8,000					
	Precise value					
	0-10,000					
Percentile value	1,000-5,000	0-5,000	0-10,000	-10,000-10,000	4,000-20,000	0-20,000
Resolution(1/16000)	0.2500mV	0.3215mV	0.6250mV	1.250mV	1.00 $\mu$ A	1.25 $\mu$ A
Range selection	Selection of input type by program or parameter (Available to be set per each channel)					
Resolution	$\pm 0.2\%$ or less (Ambient temperature 25 $^{\circ}$ C), $\pm 0.3\%$ or less (Range of operation temperature)					
Max. absolute input	$\pm 15V$				$\pm 30mA$	
Conversion speed	500 $\mu$ s/channels				250 $\mu$ s/channels	
Insulation method	Photo-coupler insulation between terminal and power supply					
Terminal	32 points				18 points	
No. of occupied I/O points (XGK)	Fixed type (Setting in basic parameter): 64 points				Variable type (Dissolving in basic parameter): 16 points	
Current consumption	DC 5V : 420mA					
Wight	140g					

## Configuration

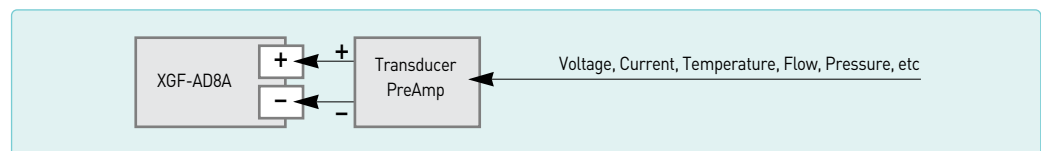

## A/D conversion characteristics

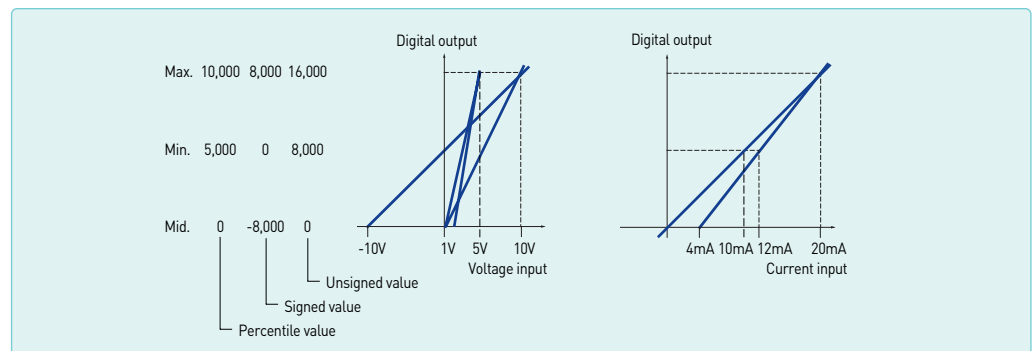

SPECIAL



## Features

- 2Wire sensor (transmitter) input
- 1/64000 resolution
- Channel insulation
- Various additional functions

## Specifications

Item		XGF-AW4S		
No. of input channel		4channels		
Voltage input		DC 1-5V(Input resistance: 11M $\Omega$ )		DC 4-20mA(Input resistance : 250 $\Omega$ )
Digital output	Signed value	-32,000-32,000		-32,000-32,000
	Precise value	1,000-5,000		4,000-20,000
	Percentile value	0-10,000		0-10,000
	Resolution(1/64000)	0.25mV		1 $\mu$ A
	Range selection	Selection of input range in program or S/W package (Available to be set per channel)		
Resolution		$\pm$ 0.05% or less (Ambient temperature 25 $^{\circ}$ C), Temp. coefficient $\pm$ 70ppm/ $^{\circ}$ C(Range of operation temperature)		
Max. absolute input		$\pm$ 6V		$\pm$ 30mA
Conversion speed		10ms/4channels		
Insulation	Item	Method	Withstand voltage	Resistance
	Channel	Transformer	500VAC, 50/60Hz, 1min, Leakage current: 10mA or less	500VDC, 10M $\Omega$ or more
	Terminal - Power	Photo-coupler		
Transmitter	Voltage	DC 24V $\pm$ 15%		
	Max. current	30mA		
	Short circuit protection	Limit current: 25 ~35mA		
External power		DC 24V + 20%, -15%		
Terminal		18 point terminal		
No. of occupied I/O points (XGK)		Fixed type (Setting in basic parameter): 64 points, Variable type (Dissolving in basic parameter): 16 points		
Current	DC 5V	180mA		
consumption	DC 24V	480mA		
Wight		140		

## Configuration

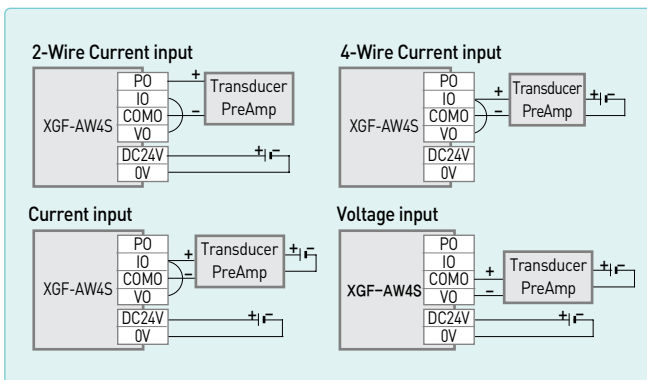

## A/D conversion characteristics

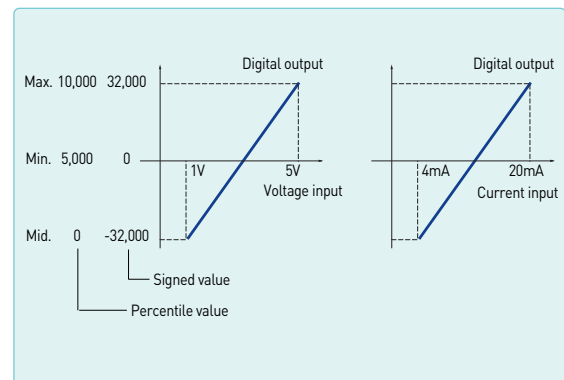

# Analog input module(Isolated)

## Features

- Channel isolation
- 1/64000 resolution
- $\pm 0.05\%$ (25°C) fixed density
- Setting and monitoring the special module parameter through XG5000



## Specifications

Item		XGF-AD4S					
No. of input channel		4 channel					
Analog input	Voltage input	DC 1-5V, DC 0-5V, DC 0-10V, DC -10-10V (Input resistance: 1M $\Omega$ )					
	Current input	DC 4-20mA, DC 0-20mA (Input resistance: 250 $\Omega$ )					
	Input selection	Dip switch			-		
	Range selection	Selection input range in the program or S/W package(Available to set per each channel)					
	Input type	Voltage input				Current input	
		DC 1-5V	DC 0-5V	DC 0-10V	DC -10-10V	DC 4-20mA	DC 0-20mA
Digital output	Signed value	-32,000-32,000					
	Precise value	0-10,000					
	Percentile value	1,000-5,000	0-5,000	0-10,000	-10,000-10,000	4,000-20,000	0-20,000
	Resolution(1/64,000)	0.2500mV	0.3215mV	0.6250mV	1.250mV	1.00 $\mu$ A	1.25 $\mu$ A
	Range selection	Selection input range in the program or S/W package(Available to set per each channel)					
Resolution		$\pm 0.2\%$ or less(Ambient temperature 25°C), $\pm 0.3\%$ or less(Range of operation temperature)					
Max. absolute input		$\pm 15V$				$\pm 30mA$	
Conversion speed		10ms/4 channel					
Isolation Standards	Item	Isolation Method		Isolation withstand voltage		Isolation resistance	
	Channels	Transformer isolation		500VAC, 50/60Hz		10M $\Omega$ or more	
	Input-PLC Power	Photo-coupler isolation					
Terminal		18 points					
No. of occupied I/O points (XGK)		Fixed type(Setting in basic parameter):64points, Variable type(Dissolving in basic parameter): 16points					
Current consumption		DC 5V: 610mA					
Wight		140					



# Analog input module (Example)

## System Configuration

This is a simple example to start Analog input module setting. For more details, refer to user's manual.

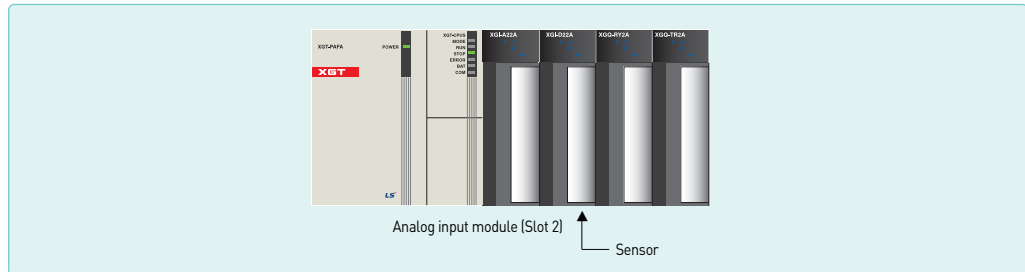

## Wiring

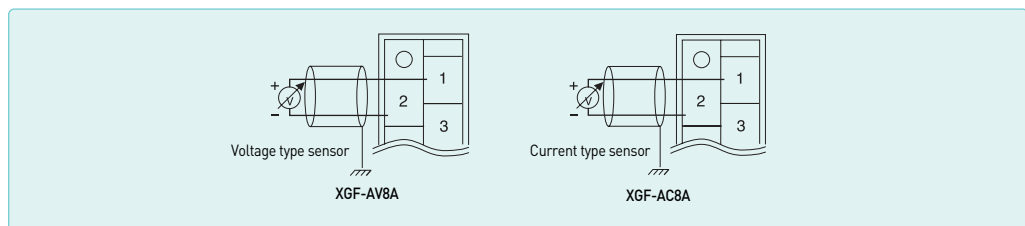

## Parameter setting

In the parameter setting box, select slot and analog module that you want to use. (This example shows to select '0' channel of voltage input type.)

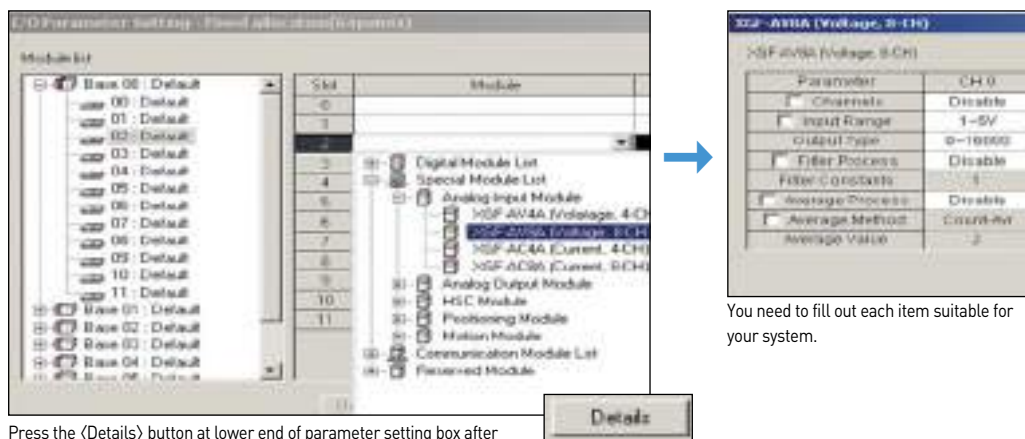

You need to fill out each item suitable for your system.

Press the <Details> button at lower end of parameter setting box after selecting the module.

## Programming

Create a program for A/D conversion (0~10V to 0~16,000).

### Special devices for programming

Refer to user's manual for more details.

U02.0.0: Error

U02.11.0: Requesting error-clear

U02.02: Memory of channel A/D value

Uxy.aa.bb

x: Base number

y: Slot number

aa,bb: Refer to user's manual.

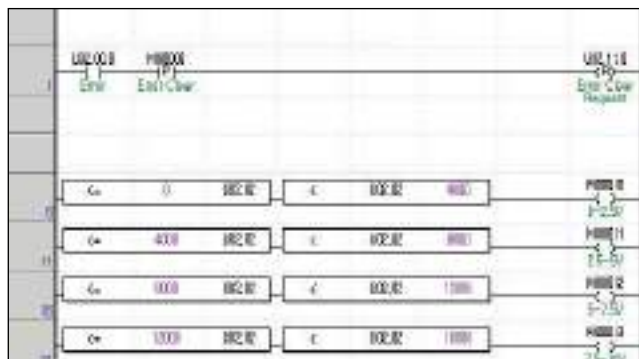

# Analog output module



## Features

- Fast conversion processing
- High resolution
- Setting and monitoring the special module parameter through XG5000
- Supporting 4 types of digital input data format

## Specifications

Item	XGF-DV4A, XGF-DV8A, XGF-DV4S (Voltage output type)				XGF-DC4A, XGF-DC8A, XGF-DC4S (Current output type)					
No. of output channel	XGF-DV4A/4S, XGF-DC4A/4S : 4 channels / XGF-DV8A, XGF-DC8A : 8 channels									
Analog output range	DC 1-5V, 0-5V				DC 4-20mA					
	DC 0-10V, -10-10V				DC 0-20mA					
Selection of input range in the program or S/W package (Available to set per each channel)										
Digital input range	Analog output	Voltage type		1-5V	0-5V	0-10V	-10-10V			
		Digital input	Unsigned value		0-16,000					
			Signed value		-8,000-8,000					
			Precise value		1,000-5,000	0-5,000	0-10,000	-10,000-10,000		
	Percentile value		0-10,000							
	Analog output	Current type		4-20mA		0-20mA				
		Digital input	Unsigned value		0-16,000					
			Signed value		-8,000-8,000					
			Precise value		4,000-20,000		0-20,000			
			Percentile value		0-10,000					
16-bit binary value: selection of input type by program or parameter (Available to be set per each channel)										
Max. resolution	1/16,000 (Per each input range)									
	1-5V		0.250mV		4-20mA		1.0μA			
	0-5V		0.3125mV							
	0-10V		0.625mV		0-20mA		1.25μA			
Accuracy	XGF-DV4A/8A, DC4A/8A : ±0.2% or less (Ambient temperature 25°C), ±0.3% or less (Range of operation temperature)									
	XGF-DV4S/DC4S : ±0.1% or less (Ambient temperature 25°C), temp coefficient: ±80ppm/°C									
Conversion speed	250μs/channel									
Max. absolute output	±15V				±24mA					
Insulation method	Photo-coupler insulation between terminal and power supply XGF-DV4A/8A, XGF-DC4A/8A: No insulation between channels XGF-DV4S, XGF-DC4S (Insulation type): Insulation between channels									
Connection terminal	18 point terminal									
No. of occupied points	Fixed type (Setting in basic parameter): assign 64 points									
	Variable type (Dissolving in basic parameter): assign 16 points									
Current consumption (mA)		DV4A	DV8A	DV4S	DC4A	DC8A	DC4S			
	Internal	190	190	200	190	190	200			
External	140	180	150	210	300	220				
Weight (Kg)	0.15									

## Output wiring

XGF-DV4A/4S/8A  
XGF-DC4A/4S/8A

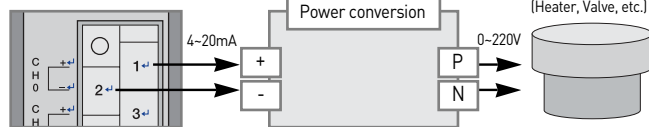

## I/O conversion characteristics

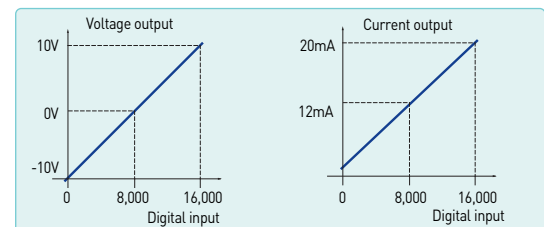

## Insulation type

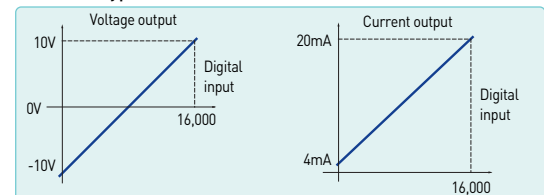

## System Configuration

This is a simple example to start Analog output module setting. For more details, refer to user's manual.

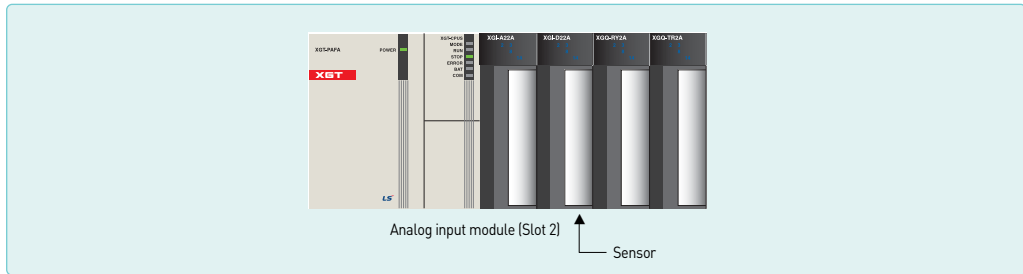

## Wiring

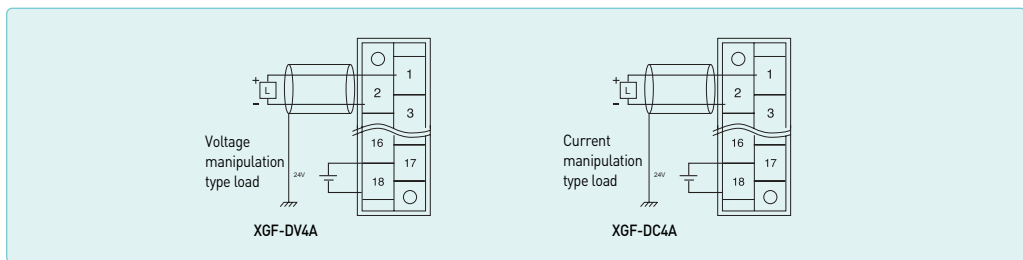

## Parameter setting

In the parameter setting box, select slot and analog module that you want to use. (This example shows to select '0' channel of voltage output type.)

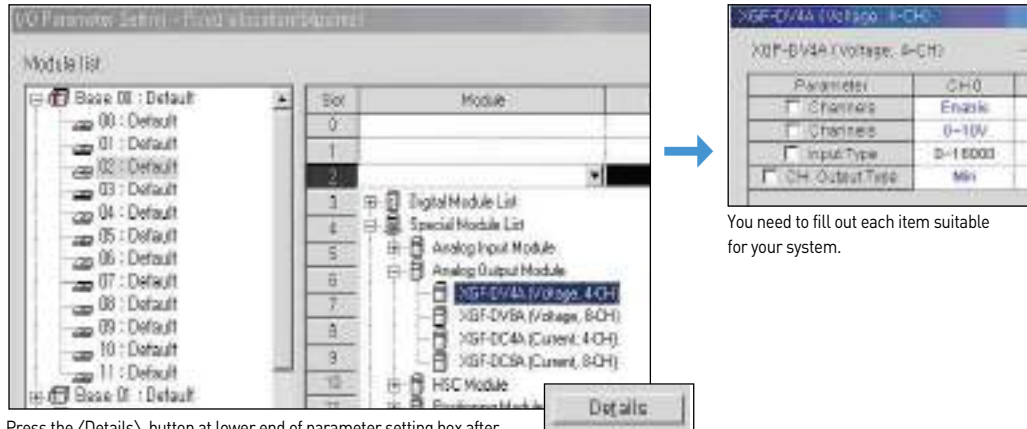

Press the <Details> button at lower end of parameter setting box after selecting the module.

You need to fill out each item suitable for your system.

## Programming

Create a program for D/A conversion (0~16000 to 0~10V).

### Special devices for programming

Refer to user's manual for more details.  
U02.02.0: Admitting Channel 0 output  
U02.03: Output data of channel 0

Uxy.aa.bb  
x: Base number  
y: Slot number  
aa,bb: Refer to user's manual.

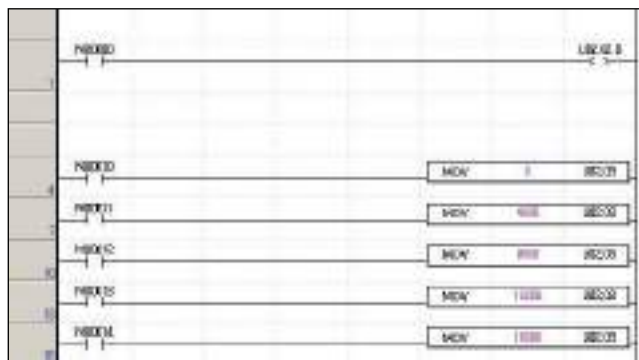



# Analog input/output module

## Features

- Input 4channels Output 2channels
- 4channels, 1/8000 resolution
- Parameter setting and monitoring by XG5000



## Specifications

Item		XGF-AH6A					
Input	No. of input channel	4channels					
	Analog output	Range	DC1-5V	DC0-5V	DC0-10V	DC-10-10V	DC4-20mA
		Resistance	1MΩ				
		Selection	V+ and COM				
	Digital output	Unsigned value	0-8,000				0-8,000
		Signed value	-4,000-4,000				-4,000-4,000
		Precise value	0-10,000				
		Percentile value	1,000-5,000	0-5,000	0-10,000	-10,000-10,000	4,000-20,000
		Resolution(1/8000)	0.5mV	0.625mV	1.25mV	2.5mV	2.0uA
	Range selection	Selection of input range in program or S/W package (Available to be set per channel)					
	Resolution	±0.2% or less (Ambient temperature 25°C), ±0.3% or less (Range of operation temperature)					
	Max. absolute input	±15V				±30mA	
Conversion speed	500ms/channels						
Output	No. of input channel	2channels					
	Analog output	Range	DC1-5V	DC0-5V	DC0-10V	DC-10-10V	DC4-20mA
		Resistance	1kΩ or more				600Ω or less
		Selection	V+ and COM				
	Digital output	Unsigned value	0-8,000				0-8,000
		Signed value	-4,000-4,000				-4,000-4,000
		Precise value	0-10,000				
		Percentile value	1,000-5,000	0-5,000	0-10,000	-10,000-10,000	4,000-20,000
		Resolution(1/8000)	0.5mV	0.625mV	1.25mV	2.5mV	2.0uA
	Range selection	Selection of input range in program or S/W package (Available to be set per channel)					
	Resolution	±0.2% or less (Ambient temperature 25°C), ±0.3% or less (Range of operation temperature)					
	Max. absolute input	±15V				±24mA	
Conversion speed	500us/channels						
Insulation method	Photo-coupler insulation between terminal and power supply						
Terminal	18 point terminal						
No. of occupied I/O points (XGK)	Fixed type (Setting in basic parameter): 64 points, Variable type (Dissolving in basic parameter): 16 points						
Current consumption (DC5V)	770mA						
Wight	140						

## Wiring

Voltage input

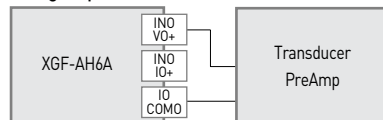

Voltage output

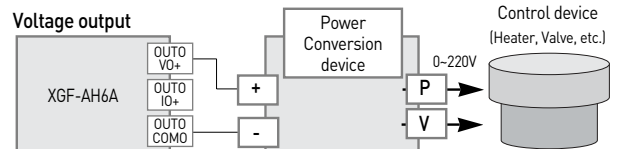

Current input

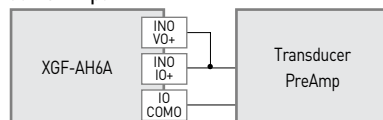

Current output

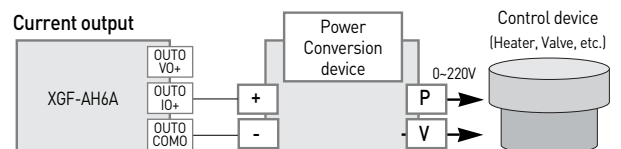

## Features

- It supports HART protocol  
In the input range of 4 ~ 20mA, bi-directional digital communication is available by using analog signal wiring. If analog wiring is currently used, there is no need to add wiring for HART communication (HART communication is not supported in the range of 0 ~ 20mA)
- High accuracy
- Operation parameters setting/monitoring
- Input disconnection detection function



## Specifications

Item		XGF-AC4H		XGF-DC4H	
No. of Channels		4channels		4channels	
Analog input/output range		DC4~20mA,DC 0~20mA, (Input Resistance 250Ω )		DC 4~20mA,DC 0~20mA, (Load resistance 600Ω or less)	
Digital input/output	Analog output/Digital input	DC4~20mA	DC0~20mA	DC4~20mA	DC0~20mA
	Signed value	-32000~32000		-8000~8000	
	Unsigned value	-		0~1600	
	Precise value	4000~2000	0~2000	4000~2000	0~2000
	Percentile value	0~10000			
Max. resolution		0 / 64000		0 / 64000	
		4~20mA:250.0nA, 0~20mA:312.5nA		4~20mA:1.00nA, 0~20mA:1.25nA	
Accuracy		±0.10% or less (when ambient temperature is 25°C±5°C)		±0.10% or less (when ambient temperature is 25°C±5°C)	
		±0.25% or less (when ambient temperature is 0°C~55°C)		±0.3% or less (when ambient temperature is 0°C~55°C)	
Conversion speed		10ms/4channels			
Absolute Max. input/output		±3mA		DC 24mA	
Analog input points		4 channels / 1module			
Isolation specification		Photo-coupler isolation between input terminal and PLC power (no isolation between channels)			
Terminal connected		18-point terminal			
I/O points occupied		Fixed type: 64 points, Non fixed type : 16 points			
HART communication method		Mono drop only Primary master only			
Internal-consumed current		DC5V:340mA		DC5V:200mA, DC24V:220mA	
Weight (g)		145		150	

# High-speed counter module

## Features

- Parameter setting and monitoring using XG5000
- Incremental encoder available
- Supporting various pulse input (5V, 12V, 24V)
- Various multiplication (1/2 phase pulse input)
- External present input
- Providing function to prevent from counting external signal
- Supporting HTL-level incremental encoder in the line-drive input type



## Specifications

Item		XGF-H02A			XGF-HD2A
No. of command	Signal	A Phase, B Phase			
	Input type	Voltage input (Open Collector)			Differential input (Line Driver)
	Signal level	DC 5/12/24V			RS-422 Line Drive/HTL LEVEL Line Drive
	Input voltage	24V DC (17.0V ~ 26.4V)	12V DC (9.8V ~ 13.2V)	5V DC (4.5V ~ 5.5V)	Line Driver
	Input current	7~11mA	7~11mA	7~11mA	RS-422 Line Drive HTL Level Line Drive
	Min. On guaranteed voltage	17.0V	9.8V	4.5V	
	Max. Off guaranteed voltage	4.5V	3.0V	1.7V	
Counter enable	Set by program (Count only in 'Enable')				
Max. counting speed	200Kpps			500Kpps (HTL input: 250Kpps)	
No. of channels	2 channels				
Counting range	Signed 32 Bit (-2,147,483,647 ~ 2,147,483,647)				
Counting type (Program setting)	Linear count (Generating Carry/Borrow when exceeding counting range, Max/Min value)				
Input mode (Program setting)	1 Phase input				
	2 Phase input				
	CW/CCW input				
Signal type	Voltage				
Up/Down counter setting	1-phase input	Program or B-phase			
	2-phase input	Phase difference			
	CW/CCW	A-phase input: Up count B-phase input: Down count			
Multiplication	1-phase input	1/2 multiplication (Programming)			
	2-phase input	1/2/4 multiplication (Programming)			
	CW/CCW	1 multiplication			
Control input	Signal	Preset signal, Signal to admit additional signal (Setting by terminal block or programming)			
	Signal level	DC 5V/12V/24V input type (Selecting terminal)			
	Signal type	Voltage			
External output	No. of output point	2 points/channel: Terminal output available			
	Type	Single comparison (>,>=,<=<) or section comparison			
	Output type	Open Collector (Sink)			
Operating status display	Input signal	A-phase, B-phase, Preset signal, Signal to admit additional signal			
	Output signal	OUT1, OUT2			
	Operation status	Module Ready, Pulse input status of A, B phase			
Addition functions (Program setting)	<ul style="list-style-type: none"> <li>• Count clear, Count latch</li> <li>• Section count (Set time value:1~60000ms)</li> <li>• Measuring counting number per a unit time (Set time value:1~60000ms)</li> <li>• Preventing from counting (Setting by internal/external input during counting)</li> <li>• Pulse frequency count (Each input channel)</li> </ul>				
No. of occupied	Fixed type (Setting in basic parameter): 64 points				
I/O points	Variable type (Dissolving in basic parameter): 16 points				
Terminal block	40-pin connector				
Current consumption	270			330	
Weight (Kg)	0.09				

## Terminal block configuration

### XGF-H02A

Pin layout	Pin number		Signal name	
	CH0	CH1		
	1	17	A12V	A phase DC12V input
	2	18	A24V	A phase DC24V input
	3	19	A_C	A phase COM
	4	20	A5V	A phase DC5V input
	5	21	B12V	B phase DC12V input
	6	22	B24V	B phase DC24V input
	7	23	B_C	B phase COM
	8	24	B5V	B phase DC5V input
	9	25	P12V	Preset DC12V input
	10	26	P24V	Preset DC24V input
	11	27	P_C	Preset COM
	12	28	P5V	Preset DC5V input
	13	29	G12V	Gate DC12V input
	14	30	G24V	Gate DC24V input
	15	31	G_C	Gate COM
	16	32	G5V	Gate DC5V input
	33	35	OUT1	Comparison output OUT1
	34	36	OUT0	Comparison output OUT0
	37	38	24V	External power supply
	39	40	24G	DC24V

## Configuration

CPU	Setting preset value	H02A/HD2A
	Setting set value	CH0
	Writing operation status	CH0
	Counter admission, Reset, Output admission	CH0
	Reading operation status	CH1
	Reading counting value	CH1

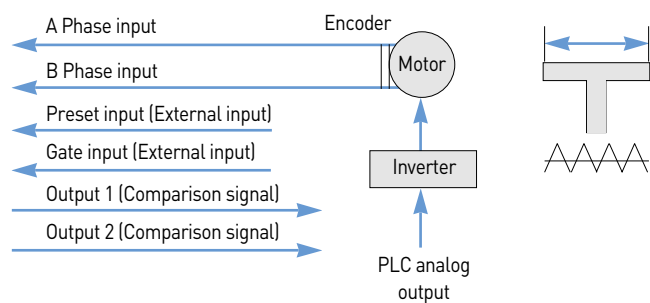

**XGF-HD2A**

Pin layout	Pin number		Signal name		
	CH0	CH1			
		1	17	AI-	AI-Input (LINEDRIVETTL LEVEL Input)
		2	18	AI+	AI+Input (LINEDRIVETTL LEVEL Input)
		3	19	AII-	AII-Input (LINE DRIVEHTL LEVEL Input)
		4	20	AII+	AII+Input (LINEDRIVEHTL LEVEL Input)
		5	21	BI-	BI- Input (LINEDRIVETTL LEVEL Input)
		6	22	BI+	BI+Input (LINE DRIVETTL LEVEL Input)
		7	23	BII-	BII-Input (LINEDRIVEHTL LEVEL Input)
		8	24	BII+	BII+Input (LINEDRIVEHTL LEVEL Input)
		9	25	P12V	Preset DC12V input
		10	26	P24V	Preset DC24V input
		11	27	P_C	Preset COM
		12	28	P5V	Preset DC5V input
		13	29	G12V	Gate DC12V input
		14	30	G24V	Gate DC24V input
		15	31	G_C	Gate COM
		16	32	G5V	Gate DC5V input
		33	35	OUT1	Comparison output OUT1
		34	36	OUT0	Comparison output OUT0
		37	38	24V	External power supply
		39	40	24G	DC24V

**Configuration**

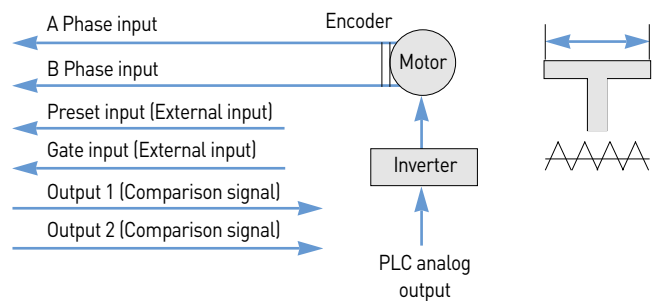
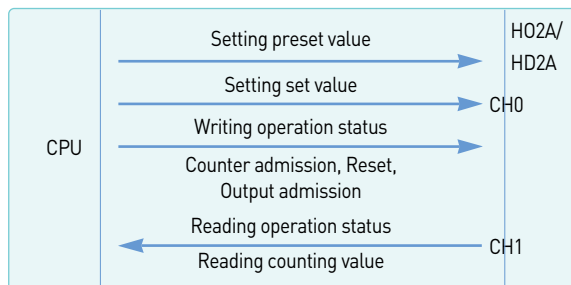



## Features

- Multiple high-speed counter input support(8ch, 80-pin connector)
- Only improve performance and safety caused by the use of FPGA enhanced
- Program controlled by the preset function
- Per 1 channel output 1 point(Program setting)
- Input filter can be set (100kpps, 10kpps, 1kpps, 0.1kpps)
- The output signal through the operation status display

## Specifications

Item		XGF-H08A
No. of Channels		8 channels
Phase		1-phase input, 2-phase input
Signal level		5V DC (7 to 11mA), 24V DC (7 to 11mA)
Input type		1/2/4 multiplication, CW/CCW
Max. counting speed		200 kpps
Input filter		None, 100kpps, 10kpps, 1kpps, 0.1kpps
Counting range		Signed 32bit (-2147483648 ~ 2147483647)
Counting type		Linear counter, Ring counter
Up/Down Counter setting	1-phase input	B-phase : Up/Down count
	2-phase input	Phase difference
	CW/CCW	A-phase : Up count, B-phase : Down count
Multiplication	1-phase input	1/2 multiplication(Programming)
	2-phase input	1/2/4 multiplication(Programming)
	CW/CCW	1 multiplication
External output	Comparison detection	Single comparison(→,→=,=←,←) or Section comparison
	Output points	1 point/channels : Internal or External output (programming)
	type	Open collector output(Sink)
Operating status display	Input signal	A-phase, B-phase
	Output signal	OUT
	Operating condition	Module ready
Addition functions(Program setting)		Counter clear, Count latch
		Section count(Set time value : 1 ~ 60000ms)
		Pulse frequency(Each input channel)
		Measuring counting number per a unit time (Set time value : 1 ~ 60000ms)
		Preventing from counting
Power		DC5V (600mA)
Terminal block		80-pin connector

This is a simple example of high-speed counter module setting.  
For more details, refer to user's manual.

## System Configuration

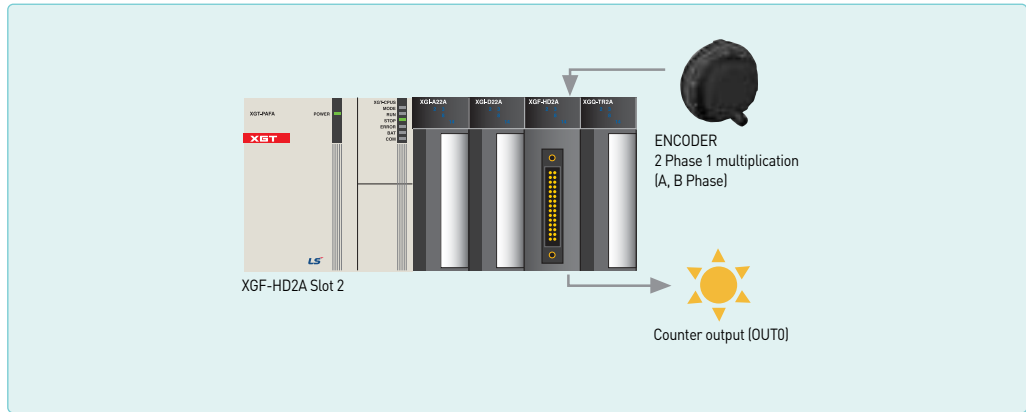

## Wiring

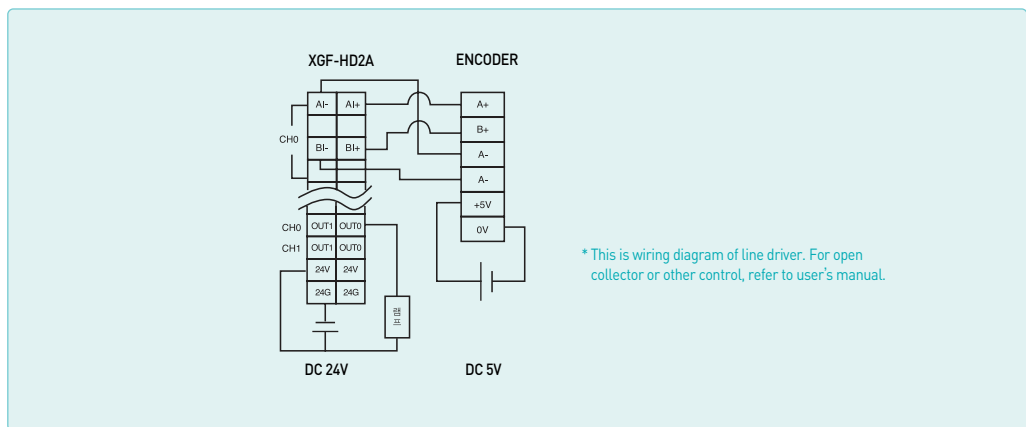

## Control configuration

- Light a lamp of output when present value reaches 1000 of pulse input counted by encoder.
- Current value of pulse is saved in D100-D101 and is monitored.

## Module test (Online)

- Module test function of XGT enables to monitor operation status of high-speed counter module and to test-run.



Select [Monitor] → [Special Module Monitoring] in menu and appoint high-speed counter.



After pressing the button for [Start Monitoring], press the button [FLAG monitor].



Change [Counter Enable] status to ON.

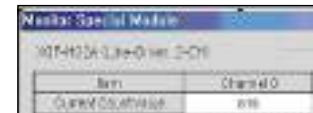

Check current counting value in 'Monitor Special Module' screen box.

## Parameter setting

- In I/O parameter setting box, select slot and analog module that you want to use. (This example shows to select 2-channel line driver.)

Press the <Details> button at lower end of parameter setting box after selecting the module.

Input 1000 as Max. and Min. comparison output.

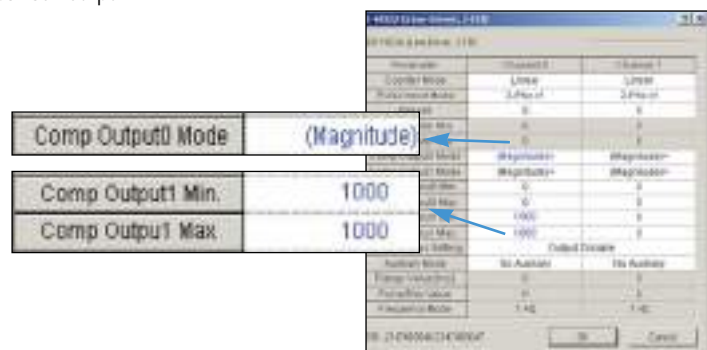
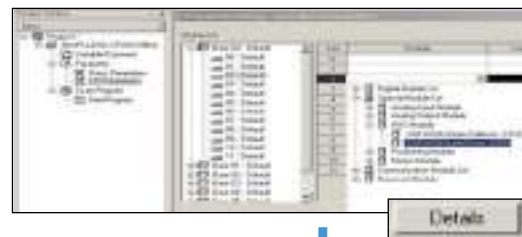



## programming

- After completing programming like following figure, download it to PLC and check operation status.

Special devices for programming

Refer to user's manual for more details.

U02.23.0: Count operation admission

U02.23.1: Count preset

U02.23.4: Consistent output admission

U02.23.5: Output external terminal admission

U02.23.6: OUT0 consistent signal reset

U02.00.6: Contact for checking external output

(Practically effective output is  
outputted through OUT0 terminal)

U02.02-U02.03: Counter present value

Uxy.aa.bb  
x: Base number  
y: Slot number  
aa,bb: Refer to user's  
manual

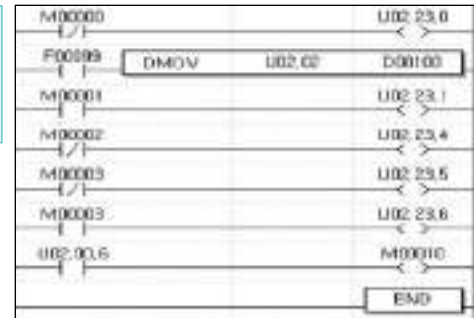

After downloading, monitor operation status.

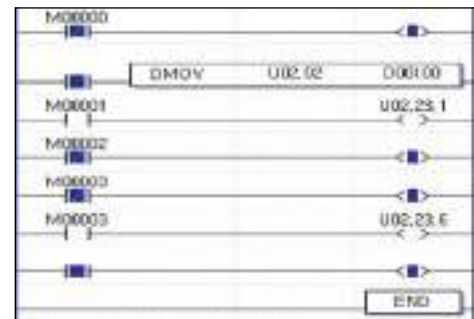

For monitoring just present value, follow the example.

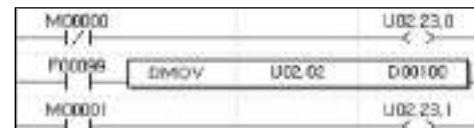

## Features

- Highly reliable position control with LSIS ASIC-embedded processor
- Enhanced control with fast control processing speed
- High-speed motor control (Max. pulse output: 1Mbps)
- Circular/linear interpolation, separate/synchronous operation
- Trapezoidal & S-curve acceleration/deceleration
- Easy and quick control through external input (JOG operation included)
- Encoder input support
- High-speed processing of command (4ms)
- Easy to set positioning parameters (Windows)
- Monitoring/Tracking/Simulation
- Available to edit operation parameter data in EXCEL
- Self-diagnosis
- Real-time information and solution for each error



## Specifications

Item	Specifications			
	XGF-P01A, XGF-PD1A	XGF-P02A, XGF-PD2A	XGF-P03A, XGF-PD3A	
Number of axis	1	2	3	
Interpolation		2-axis linear interpolation, 2-axis circular interpolation	2/3-axis linear interpolation, 2-axis circular interpolation	
Control method	Position control, speed control, speed/position control, position/speed control			
Setting unit	Pulse, mm, inch, degree			
Positioning data	Each axis has 400 data items (Operation step number 1~400). It is available to set with software package or programming.			
Software package	Available (Connected with RS-232C Port of CPU module)			
Data backup	Flash memory (No battery)			
Positioning	Positioning method	Absolute / relative method		
	Position address range	mm	-214748364.8 ~ 214748364.7 (μm)	
		Inch	-21474.83648 ~ 21474.83647	
		Degree	-21474.83648 ~ 21474.83647	
		Pulse	-2147483648 ~ 2147483647	
	Type	XGF-PO□A: Open collector, XGF-PD□A: Line Driver		
	Position speed range	mm	0.01 ~ 20000000.00 (mm/min)	
		Inch	0.001 ~ 2000000.000 (inch/min)	
		Degree	0.001 ~ 2000000.000 (degree/min)	
		Pulse	XGF-PO□A: 1~200,000 (pulse/sec), XGF-PD□A: 1~1,000,000 (pulse/sec)	
Accel/Decel pattern	Trapezoidal & S-curve acceleration/deceleration			
Accel/Decel time	1 ~ 65,535ms			
Max. output pulse	XGF-PO□A: 200Kpps / XGF-PD□A: 1Mpps			
Max. distance	XGF-PO□A: 2m / XGF-PD□A: 10m			
Max. encoder input	200 Kpps			
Error display	LED			
Operation display	LED			
Connection connector	40 Pin connector			
Size of cable	AWG #24			
Occupied points of I/O	64 points (Fixed type), 16 points (Variable type)			
Current consumption (mA)	XGF-P01A: 340	XGF-P02A: 360	XGF-P03A: 400	
	XGF-PD1A: 510	XGF-PD2A: 790	XGF-PD3A: 860	
Weight (kg)	0.12	0.13	0.135	

\* XGF-PO□O: Open Collector type, □: Number of axis  
 XGF-PD□D: Line Drive type, □: Number of axis

## Terminal block configuration

Pin layout



1 axis

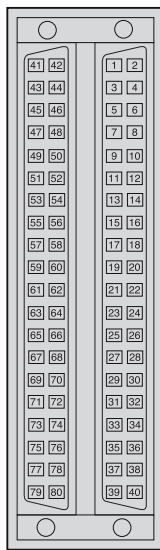

2/3 axes

For	Pin number			Signal name		Signal direction APM - Ext. device	Condition	
	X	Y	Z					
A x i s	21	41	61	FP+	Pulse output (Differential +)	→		
	22	42	62	FP-	Pulse output (Differential -)	→		
	23	43	63	RP+	Pulse sign (Differential +)	→		
	24	44	64	RP-	Pulse sign (Differential -)	→		
	25	45	65	OV+ *	High limit	←	┌	
	26	46	66	OV- *	Low limit	←	└	
	27	47	67	STOP	External stop signal	←	┌	
	28	48	68	DOG	Approximate origin	←	┌	
	29	49	69	VTP	Speed/Position switching signal	←	┌	
	30	50	70	ECMD	External command signal	Start	←	┌
						Skip	←	┌
						JOG+ (Forward)	←	┌
	31	51	71	JOG-	JOG reverse operation	←	┌	
	32	52	72	COM	Common(OV+, OV-, STOP, DOG, VTP, ECMD, JOG-)	↔		
	33	53	73	DR/INP	Imposition/Driver Ready signal	←	┌	
	34	54	74	DR/INP COM	Imposition/Driver Ready signal Common	↔		
	35	55	75	HOME +24V	Zero signal (+24V)	←	┌	
	36	56	76	NC	Not used			
	37	57	77	HOME +5V	Zero signal (+5V)	←	┌	
	38	58	78	HOME COM	Zero signal (+24V, +5V) Common	↔		
39	59	79	24V	24V Power supply (Not used in case of line drive output)				
40	60	80	P COM	External 24V GND (Not used in case of line drive output)				
C o m m o n	1			MPG A+	Manual pulse generator/Encoder A+ Input	←		
	2			MPG A-	Manual pulse generator/Encoder A- Input	←		
	3			MPG B+	Manual pulse generator/Encoder B+ Input	←		
	4			MPG B-	Manual pulse generator/Encoder B- Input	←		
	5			NC	Not used	←		
	6			NC	Not used	←		
	7			CON	External simultaneous start	←	┌	
	8			EMG *	Emergency stop	←	└	
	9			NC	Not used			
	10			COM	(CON, EMG) Common	↔		
	11~20			NC	Not used			



## Features

- Max 4Axis, Max pulse output 4Mpps
- Circular/linear/ellipse/helical interpolation
- Asymmetric acceleration and deceleration driving
- FRAM parameter
- XG5000 monitoring, simulation, trace
- CAM profile program



## Specifications

Item		XGF-P01H XGF-PD1H	XGF-P02H XGF-PD2H	XGF-P03H XGF-PD3H	XGF-P04H XGF-PD4H
Number of axis		1 axis	2 axis	3 axis	4 axis
Interpolation		—	Circular, linear, ellipse	Circular, linear, helical, ellipse	
Control method		Position control, speed control, speed/position control, position/speed control, FEED			
Positioning data		Each axis has 400 data items (Operation step number 1~400). It is available to set with XG5000 or programming.			
Configuration Tool		XG5000 (Connected with USB or RS-232C Port of CPU module)			
Data backup		FRAM (Parameter, Operation data), Flash memory (CAM Data), No battery			
Pulse output		XGF-POxH: Open collector, XGF-PDxH: line driver			
Positioning	Positioning method		Absolute / Incremental		
	Position address range	mm	-214,748,364.8 ~ 214,748,364.7(μm)		
		inch	-21,474.83648 ~ 21,474.83647		
		degree	-21,474.83648 ~ 21,474.83647		
		pulse	-2,147,483,648 ~ 2,147,483,647		
	Position address speed	mm	0.01 ~ 20,000,000.00(mm/min)		
		inch	0.001 ~ 2,000,000.000(inch/min)		
		degree	0.001 ~ 2,000,000.000(degree/min)		
		pulse	1 ~ 500,000(pulse/sec): Open collector, 1 ~ 4,000,000(pulse/sec): line driver		
		RPM	0.1 ~ 100,000.0(RPM)		
Accel/Decel pattern		Trapezoidal & S-curve acceleration/deceleration			
Accel/Decel time		0~2,147,483,647ms			
Max. output pulse		Open collector: 500kpps, line driver: 4Mpps			
Max. distance		Open collector: 5m, line driver: 10m			
Max. encoder input		500kpps			
Error display		LED			
Size of cable		AWG #24			
Occupied points of I/O		64 points (Fixed type), 16 points (Variable type)			
Connection connector		40Pin		80Pin	
Current consumption (mA)		XGF-P01H:400mA	XGF-P02H:410mA	XGF-P03H:420mA	XGF-P04H:430mA
		XGF-PD1H:520mA	XGF-PD2H:600mA	XGF-PD3H:850mA	XGF-PD4H:890mA
Weight (kg)		120		130	

### Terminal block configuration

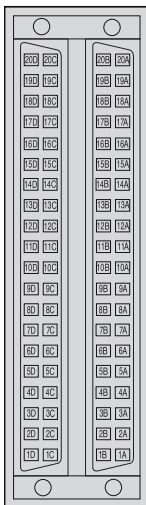

Pin number				Signal name	Remarks
AX1	AX2	AX3	AX4		
20A				MPG A+	Manual pulse generntor /Encoder A+ input
20B				MPG A-	Manual pulse generntor /Encoder A- input
19A				MPG B+	Manual pulse generntor /Encoder B+ input
19B				MPG B-	Manual pulse generntor /Encoder B- input
20C, 19C, 20D, 19D				NC	Not used
18A	18B	18C	18D	FP+	Foward pulse (‡)
17A	17B	17C	17D	FP-	Foward COM (-)
16A	16B	16C	16D	RP+	Backward pulse (‡)
15A	15B	15C	15D	RP-	Backward COM (-)
14A	14B	14C	14D	OV+	Max. signal
13A	13B	13C	13D	OV-	Min. signal
12A	12B	12C	12D	DOG	Appoximate orgin signal
11A	11B	11C	11D	EMG	Emergency stop
				STOP	External stop signal
10A	10B	10C	10D	VTP	Speed / Position switching signal
9A	9B	9C	9D	COM	Common (OV+,OV-,DOG,EMG,STOP,VTP)
8A	8B	8C	8D	DR	Drive ready signal
7A	7B	7C	7D	INP	In-position
6A	6B	6C	6D	DR/INP COM	Drive ready/ In-position Common
5A	5B	5C	5D	CLR	Deviation counter clear signal
4A	4B	4C	4D	CLR COM	Deviation counter clear signal Common
3A	3B	3C	3D	HOME +5V	Zero signal (+5V)
2A	2B	2C	2D	HOME COM	Zero signal (+5V) Common
1A, 1C				+24V	+24V
1B, 1D				+24V COM	+24V GND

\* Open collector type module : +24V (1A/1C: 24V, 1B/1D: 0V)

## Features

- XGF-PN8A : Dedicated LSIS EtherCAT Network Support (XGT Servo N series)
- XGF-PN8B : Standard EtherCAT Network Support(Standard EtherCAT Servo)
- Direct connect with servo driver Max 8
- 2~8 axis linear interpolation, 2axis circular interpolation, 3axis helical interpolation
- Position, speed, feed control is possible through the various operation
- Parameters, the operation data stored in the FRAM(without Battery)
- CAM for controlling up to eight different types of CAM data



## Specifications

Item		XGF-PN8A/PN8B	XGF-PN4B		
Number of axis		8 axis	4 axis		
Interpolation		2~8 axis linear, 2axis circular, 3axis helical interpolation			
Control method		Position, speed, Speed/position, position/speed position/torque, Feed control			
Setting unit		pulse, mm, inch, degree			
Positioning data		Each axis has 400 data items (Operation step number 1~400). It is available to set with software package or programming.			
XG5000	Port	RS-232C, USB			
	Data	Basic, expansion, manual, servo parameter, operation data, cam data, command information			
	Monitor	Operation, trace, input sort, error information			
Back-up		FRAM(parameter, operation data) no battery			
Positioning	Positoning method	Absolute/Incremental			
	Position address range		Absolute	Incremental	Speed/position, position/speed conversion control
		mm	-214748364.8 ~ 214748364.7(μm)	-214748364.8 ~ 214748364.7(μm)	-214748364.8 ~ 214748364.7(μm)
		inch	-21474.83648 ~ 21474.83647	-21474.83648 ~ 21474.83647	-21474.83648 ~ 21474.83647
		degree	-21474.83648 ~ 21474.83647	-21474.83648 ~ 21474.83647	-21474.83648 ~ 21474.83647
	Position speed range	pulse	-2147483648 ~ 2147483647	-2147483648 ~ 2147483647	-2147483648 ~ 2147483647
		mm	0.01 ~ 2000000.00(mm/Min)		
		inch	0.001 ~ 200000.000(inch/Min)		
		degree	0.001 ~ 200000.000(degree/Min)		
		pulse	1 ~ 20.000.000(pulse/Sec)		
RPM	0.1 ~ 10000.0(RPM)				
Accel/Decel pattern		Trapezoidal & S-curve acceleration/deceleration			
Accel/Decel time		1~2.147.483.647 ms			
Manual		Jog/MPG/ inching			
Homing method		Max+Z(Forward), Min+Z(Backward), Near-point+Z(Forward, Backward), Max+near-point+Z(Forward, Min+near-point+Z(Backward), Z(Forward, Backward), near-point(Forward, Backward)			
The ability to Change speed		Absolute/Percent			
Torque		Rated torque %			
Absolute position System		0 (Absolute encoder type servo)			
Encoder input	Channel	2 Channel			
	Max. Input	Max. 200 Kpps			
	Input method	line-drive input(RS-422A IEC), open collector output type			
	Type	CW/CCW, Pulse/Dir, Phase A/B			
	Connector	12 Pin connector			
Communication Cycle		800 μs			
Max. distance		100 m			
Cable		STP(Shielded Twisted pair) cable			
Error display		LED			
Operation display		LED			
Occupied points of I/O		64points(Fixed type), 16points(Variable type)			
Current consumption (mA)		500 mA			
Weight(kg)		115 g			

### Terminal block configuration

Pin layout	Pin Number	Signal name	
ENC1A+	1	ENC1A+	Encoder1 A +input
ENC1A-	2	ENC1A-	Encoder1 A - input
ENC1B+	3	ENC1B+	Encoder1 B +input
ENC1B-	4	ENC1B-	Encoder1 B - input
ENC1Z+	5	ENC1Z+	Encoder1 Z +input
ENC1Z-	6	ENC1Z-	Encoder1 Z - input
ENC2A+	7	ENC2A+	Encoder2 A +input
ENC2A-	8	ENC2A-	Encoder2 A - input
ENC2B+	9	ENC2B+	Encoder2 B +input
ENC2B-	10	ENC2B-	Encoder2 B - input
ENC2Z+	11	ENC2Z+	Encoder2 Z +input
ENC2Z-	12	ENC2Z-	Encoder2 Z - input

### External encoder wiring

	Pin Number	Signal	
<p>* Open collector type</p>	1	ENC1A+	Encoder1 A +input
	2	ENC1A-	Encoder1 A - input
	3	ENC1B+	Encoder1 B +input
	4	ENC1B-	Encoder1 B - input
	5	ENC1Z+	Encoder1 Z +input
	6	ENC1Z-	Encoder1 Z - input
<p>* line-drive type</p>	7	ENC2A+	Encoder2 A +input
	8	ENC2A-	Encoder2 A - input
	9	ENC2B+	Encoder2 B +input
	10	ENC2B-	Encoder2 B - input
	11	ENC2Z+	Encoder2 Z +input
	12	ENC2Z-	Encoder2 Z - input



**Features**

- Configuration tool with updated APM software package
- All models can be used for XGT Positioning module (APM, XPM)
- Simultaneous communications can be accessed with XG5000
- Powerful simulation, trace, monitoring



System View

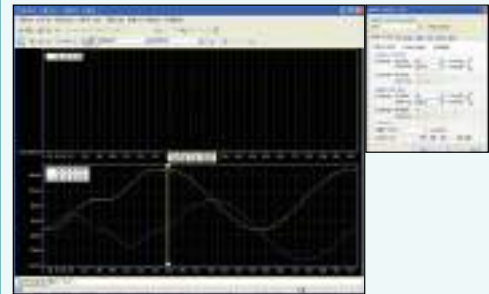

Data trace (trend graph)

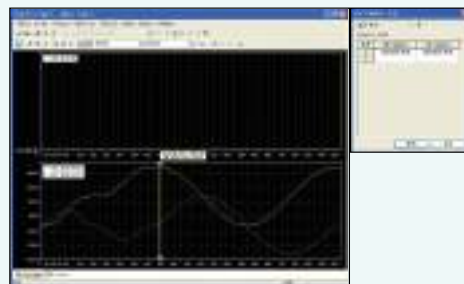

Data trace (XY graph)

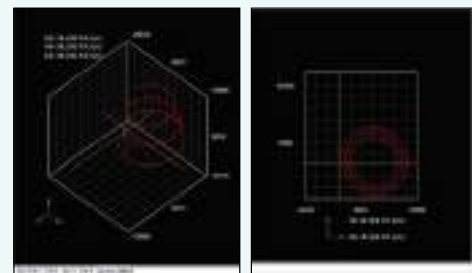
XYZ trend  
(3D View)XYZ monitor  
(2D View)

CAM control profile



Simulation



# Motion Module[EtherCAT]

## Features

- 32 axes (master) and 4 axes (virtual) control
- EtherCAT CoE supported servo drive
- Communication cycle : 1ms
- Built-in DI/DO 8 points each and EtherCAT I/O 512 points
- Program 2MB
- External encoder input 2ch (line drive)
- Max. transmission distance : 100m



## Specifications

Item		XGF-M32E
Communication		EtherCAT (CoE : CANopen over EtherCAT)
Number of axis	Real	32 axes
	Virtual	4axes
	I/O	Input/output 8 points each (built-in) EtherCAT I/O connection available
Control period		1ms, 2ms, 4ms (same as main task period)
Control unit		Pulse, mm, inch, degree
I/O	Internal	Input 8 points, output 8 points
	External	EtherCAT I/O 4 ea(max. 256 points)
Motion Program	No. of program	Max. 256 ea
	Capacity	Max. 2Mbyte
	Language	LD(FB), ST
	Position data	6400 points/all aixs
Control method		Position, Velocity, Torque(Servo drivers support) control, Synchronous control, Interpolation control
Range of position/velocity		± LREAL, 0
Acc. Dec. process		Trapezoid type, S-type (Setting to specify the Jerk at function block)
Acc. Dec. time		1 ~ 2, 147, 483, 647ms
Manual operation		JOG operation
Torque unit		Rated torque % designation
Encoder input	Channel	2 chennels
	Max. input	Max. 500Kpps
	Input method	Line drive input (RS-422A IEC specification) Open collector output type encoder
	Input type	CW/CCW, Pulse/Dir, Phase A/B
Max. distance		100m
Communication cable		Over CAT.5 STP(Shielded Twisted-pair) cable
Error indication		Indicated by LED
Communication status indication		Indicated by LED
Occupied point I/O		Variable: 16 point, Fixed: 64 point
Communication physical layer		100BASE-TX
Consumable current(mA)		900mA
Weight		122g

## System Configuration

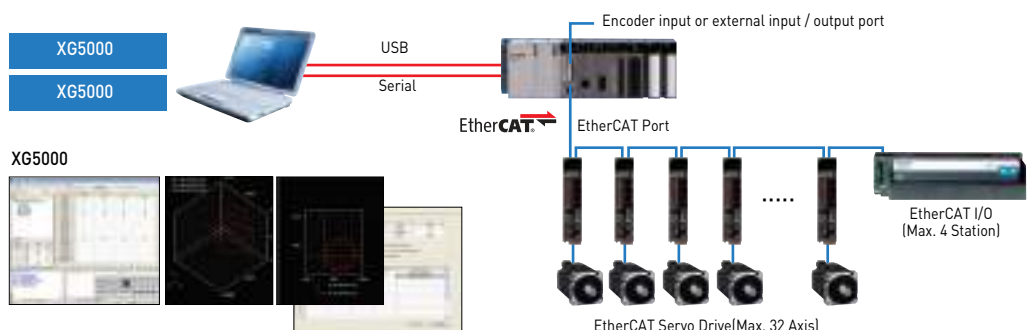



## Features

- Supports various additional functions (average, alarm, filter)
- Special module parameter setting and monitoring with XG5000
- Supports digital conversion, temperature display and user scaling
- Support Offset/Gain function(only RD8A)

## Specifications

Item		XGF-RD4A	XGF-RD4S	XGF-RD8A	
No. of input channel		4 channels	4 channels	8 channels	
Input sensor type	Pt100	JIS C1604-1997	JIS C1604-1997	JIS C1604-1997	
	JPt100	JIS C1604-1981, KS C1603-1991	JIS C1604-1981, KS C1603-1991	JIS C1604-1981, KS C1603-1991	
	PT1000	-	JIS C1604-1997	-	
	NI100	-	DIN 43760-1987	-	
Temperature input range	Pt100	-200.0 ~ 850.0°C	-200.0 ~ 850.0°C	-200.0 ~ 850.0°C	
	JPt100	-200.0 ~ 640.0°C	-200.0 ~ 640.0°C	-200.0 ~ 640.0°C	
	PT1000	-	-200.0 ~ 850.0°C	-	
	NI100	-	-60.0 ~ 180.0°C	-	
Digital output	Temperature display (unit: 0.1)	Pt100	-2,000 ~ 8,500	-2,000 ~ 8,500	-2,000 ~ 8,500
		JPt100	-2,000 ~ 6,400	-2,000 ~ 6,400	-2,000 ~ 6,400
		PT1000	-	-2,000 ~ 8,500	-
		NI100	-	-2,000 ~ 1,800	-
	Scaling display (Customize)	0 ~ 65535 -32768 ~ 32767			
Accuracy	Normal temp.[25°C]	±0.2%	±0.1%	±0.2%	
	Full temp.[0~55°C]	±0.3%	±70ppm/°C	±0.3%	
Conversion speed		40ms / channel			
Insulation	Channel to Channel	Non-insulation	Insulation	Non-insulation	
	Terminal to PLC Power	Photo-coupler			
Wiring method		3-wire	4-wire	3-wire	
Function	Average	Time average (320~64000ms)			
		Counting average(2~64000 count)			
		Moving average(2~100 samples)			
	Alarm	Process alarm			
		Input changing rate alarm			
Disconnection detection					
Offset / Gain	-	-	0		
Filtering	Digital filter (160~64000ms)				
Terminal block		18-point terminal block			
Current consumption		5V: 450mA	5V: 720mA	5V: 450mA	
Weight [g]		150g			

## Characteristics of temperature conversion

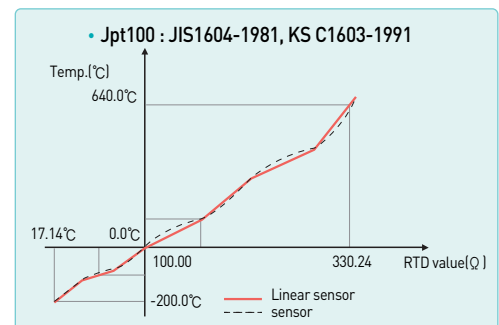
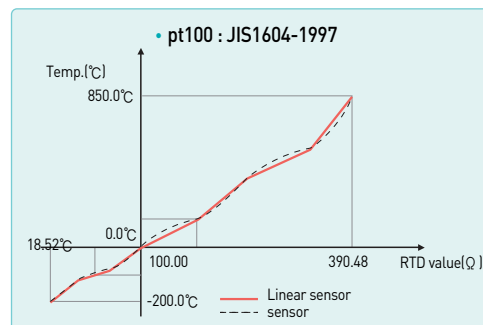

## Wiring

• Connection with 2-Wire type sensor

• Connection with 3-Wire type sensor

• Connection with 4-Wire type sensor

1) When sensor and compensating wire are shielded, shield-connection to FG terminal of the module is available.  
 2) The wiring of 4-wire type sensor is identical with the wiring of 3-wire type sensor. 3 wires is connected to the module. But the other wire is not connected with the module.

# Thermocouple module



## Features

- Insulation between channels
- $\pm 0.1\%$  (25°C) constant density
- Supports various input sensor (supporting C-type sensor)
- Various additional functions (average, filter, alarm, max/min value display)
- Special module parameter setting and monitoring with XG5000

## Specifications

Item	XGF-TC4S	
Input channels	4 channels	
Input sensor type	K, J, E, T, B, R, S, N, C	JIS C1602-1995ITS-90
Input temperature range	K	-250 ~ 1350°C
	J	-200 ~ 1200°C
	E	-250 ~ 1000°C
	T	-250 ~ 400°C
	B	400 ~ 1800°C
	R	-50 ~ 1750°C
	S	-50 ~ 1750°C
	C	-270 ~ 1300°C
Digital output	Temperature display (unit: 0.1)	Display down to the first decimal place (0.1°C)
	Scaling	0 ~ 65535
	(User range setting)	-32768 ~ 32767
Accuracy	Normal temp. (25°C)	$\pm 0.1\%$
	Temperature coefficient (Operating temp. range)	Some section can permit 0.5% $\pm 100\text{ppm}/^\circ\text{C}$
Conversion speed	40ms/ channel	
Insulation	Between channels Insulation	
	Between terminals and power	Insulation(Photo-Coupler)
Compensation	Automatic compensation by RJC sensing (PT100)	
	Compensation degree	$\pm 1.0\%$
Function	Average	Average time (320 ~ 6400ms)
		Average number (2 ~ 64000)
		Average move (2 ~ 100)
	Alarm	Process Alarm
		Change rate alarm
Filter	Digital filter (160 ~ 64000ms)	
Max./Min. values display	Max./Min. values display	
Terminal block	18-point terminal block	
Current consumption	5V : 610mA	
Weight (kg)	0.150	

## Input wiring

**terminal block for compensating wire extension**

- 1) When sensor and compensating wire are shielded, shield connection to FG terminal is available.
- 2) To minimize an error, overall temperature of block terminal need to be equal.
- 3) Compensating sensor should be the same type of sensor which is used for measurement.

## Characteristics of I/O conversion

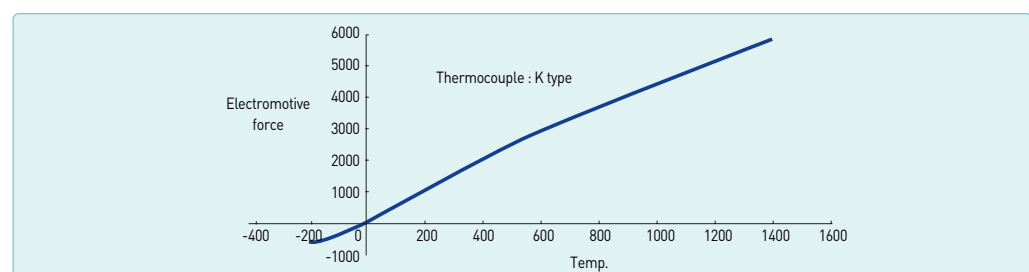

## Features

### XGF-TC4UD

- Optimum temperature control
- Universal input: TC, RTD, Voltage, Current
- Isolated input
- Output: Current/Transistor
- Parameter setting via dedicated software: TG-CON
- Variety of control types
  - PID control
  - Cascade control
  - On/ Off control
- Disconnection detection
- Various input functions: Bias, Filter, Square root
- Auto-tuning

### XGF-TC4RT

- Input RTD : Pt100, JPt100, Pt1000
- Control Type : PID, On / Off Control



## Specifications

Item	XGF-TC4UD		XGF-TC4RT	
No. of loop	4 loops		4 loops	
Input	Thermo couple	K	-200 ~ 1300 °C	-
			0 ~ 500 °C	
		J	-200 ~ 1200 °C	
			0 ~ 500 °C	
		E	-200 ~ 1000 °C	
		T	-200 ~ 400 °C	
		B	400 ~ 1800 °C	
		R	0 ~ 1700 °C	
		S	0 ~ 1700 °C	
		N	-200 ~ 1300 °C	
		C(W5Re/W26Re)	0 ~ 2300 °C	
		PL II	0 ~ 1300 °C	
	L	-200 ~ 900 °C		
	U	-200 ~ 600 °C		
	RTD	Pt100	-200 ~ 850 °C	-200 ~ 850 °C
		JPt100	-200 ~ 600 °C	-200 ~ 600 °C
		Pt1000	-200 ~ 800 °C	-200 ~ 800 °C
	Voltage	DC mV	0 ~ 10mV	-
			0 ~ 100mV	
		DC V	0 ~ 1V	
1 ~ 5V				
0 ~ 5V				
0 ~ 10V				
-5V ~ 5V				
10V ~ 10V				
Current	DC mA	4 ~ 20mA	-	
		0 ~ 20mA		
Input channel	4 channels(Input type selection per channel)		-	

## Specifications

Item	XGF-TC4UD		XGF-TC4RT		
<b>Resolution</b>	Resolution Refer to the user's manual (Resolution for each input type)				
<b>Cold junction compensation</b>	Compensation	Automatic compensation by RJC sensor			
	Precision	±0.2°C			
<b>Digital output</b>	Temperature display	0.1°C/1°C (Selection by software)			
	Linear display	0-1000			
	Scale display	Only for voltage/current input Range : -3,000-3,000 Setting range: 0-3000			
<b>Conversion speed</b>	200ms / module		400ms / 4loops		
<b>Control type</b>	PID, On/Off control				
<b>Parameter</b>	Set value (SV)	Selection per input type			
	Gain	0 : ON/OFF control, Real type			
	Integrated time	0 : No Differential control, Real type			
	Differential time	0 : No Integrated control, Real type			
<b>Output</b>	No. of output channel		8 channels (PWM or analog output)		
	PWM	Rated load voltage	DC 24V		
		Max. current point	0.1A points		
		On voltage drop	DC 0.3V or less		
		Off leakage current	0.1mA or less		
		Response time	ON⇒OFF	1ms or less	
			OFF⇒ON	1ms or less	
		Periodic	0.5-120.0sec (resolution: 0.5sec)		
	Time resolution	High value between 10ms or 0.5% of full scale			
	Analog output	Range	4-20mA		
		Resistance	600Ω or less		
Resolution		±1.0%, 25°C			
Precision		8μA			
<b>Insulation</b>	<b>Item</b>	<b>Insulation</b>	<b>Insulation withstand voltage</b>	<b>Insulation resistance</b>	
	Channel - Channel	Trans	500V AC, 50/60Hz 1min, Leakage 10mA or less	500V DC, 10MΩ or more	
	Input terminal - PLC	Photocoupler			
	Current output - Current output	Non insulation			
External power- Output					
<b>Warm-up</b>	20min or more			-	
<b>Terminal</b>	18 points terminal				
<b>Power</b>	5V, DC 24V (external)				
<b>Current consumption</b>	DC 5V : 900mA (Internal) DC 24V : 300mA (external)		DC 5V: 310mA DC 24V: 28mA		

### Example : Constant temperature

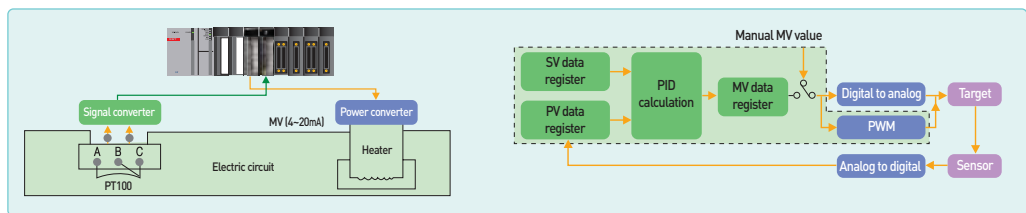

### XG-TCON

- The configuration tool for the temperature control module
- Easy parameter settings, data monitoring and trend-monitor support
- Auto-tuning operation command to speed up the system is set up and test operation



Data Monitor



Parameter setting(input parameter)



Trend monitor

SPECIAL



## Features

- SOE: Sequence Of Events Recorder
- I/O information collection to analyze the control system in Generation and Transformer
- Event collection in every 1ms
- Max. 300ea data available
- Data retain by built-in memory
- Max. installable module: 16ea
- Event monitoring of history through SOE Viewer

## Specifications

Item	XGF-SOEA
No. of input point	32 points
Insulation method	Photo-Coupler Insulation
Memory size	1Mbit
The first event setting time	CPU RTC : 1 ms (±2ms : delay between modules) RS-422 IRIG-B : 1 ms (±0.5ms : delay between modules)
Rated input voltage	DC24V
Rated input current	Approx. 4mA / points
Voltage range	DC20.4 ~ 28.8V(5% and lower ripple rate)
On voltage/On current	DC19V and higher / 3 mA and higher
Off voltage/ Off current	DC11V and lower/ 1.7 mA and lower
Input resistance	Approx. 5.6 kΩ
Response time (ms)	Off → On : 100us+Input filter time(User setting: 0~100ms) On → Off : 150us+Input filter time(User setting: 0~100ms)
Clock Synchronization	CPU RTC or RS-422 by IRIG-B format
Withstand voltage	AC560V rms / 3 Cycle (altitude 2000m)
Insulation resistance	10MΩ and higher (DC500V)
COMM method	32point / COM
Current consumption	0.4 A (MAX)
Operation display	LED On with Input On
External connection method	40point connector
Size(mm)	27x98x90
Weight	0.2 kg

## SOE Viewer



Monitoring window



Parameter setup



## Features

- Capable to easily save PLC device data without PC
- Capable to save PLC control data without missing any change
- Data can be saved whenever scanning is done or they can be saved at an interval of several ms(millisecons).
- Capable to save a large volume of data file
- Long-term data saving is available since CF card and USB memory with a large volume of up to 16GB can be used.

## Specifications

Item		XGF-DL16A				
CF Card	Voltage of power supply	3.3V ± 5%				
	Card Type	CF200I(Transcend 's Industrial CF card)				
	Compatibility Capacity	1, 2, 4, 8, 16Gbyte				
	Number of mountable cards	1				
	Caution	Use only industrial CF cards manufactured by Transcend				
USB Memory	Voltage of power supply	5.0V ± 5%				
	Memory Type	USB 2.0 (Host function)				
	Compatibility Capacity	1, 2, 4, 8, 16Gbyte (Please use USB capacity above CF card capacity)				
	Saving Method	Auto Saving through PnP function (Activation of PnP auto duplication: when USB is mounted, when power is supplied again)				
	Number of mountable memories	1(Unavailable to support USB extension cables)				
Data Type	BOOL	0 or 1				
	BYTE	00 ~ FF				
	WORD	0000 ~ FFFF				
	DWORD	00000000 ~ FFFFFFFF				
	LWORD	00000000 00000000 ~ FFFFFFFF FFFFFFFF				
	SINT	-128 ~ 127				
	INT	-32, 768 ~ 32, 767				
	DINT	-2, 147, 483, 648 ~ 2, 147, 483, 647				
	LINT	-576, 460, 752, 303, 423, 488 ~ 576, 460, 752, 303, 423, 487				
	USINT	0 ~ 255				
	UINT	0 ~ 65,535				
	UDINT	0 ~ 4,294,967,295				
	ULINT	0 ~ 1,152,921,504,606,846,975				
	REAL	-3.402823466e+038 ~ -1.175494351e-038 or 0 or 1.175494351e-038 ~ 3.402823466e+038				
LREAL	-1.7976931348623157e+308 ~ -2.2250738585072014e-308 or 0 or 2.2250738585072014e-308 ~ 1.7976931348623157e+308					
	STRING	Fixed letters (Maximum 8 letters)				
Data Saving	Number of Settings	Maximum 8				
	Number of Data	Maximum 32				
	Saving Kind	Saved by the ladder program				
	File Type	CSV file(Extension: csv)				
	Number of Saving Files	Total 800 (when using 16Gbyte CF memory)				
SavingSpeed	Processing Score(word)	4	16	64	256	1024
	Processing Speed(ms)	1	4	10	30	120
Time to Initialize CF card	Capacity(Gbyte)	1	2	4	8	16
	Time(s)	10	20	40	60	120
	Collection Interval	1 ~ 9999999 ms (In consecutive saving)				
	In/output Occupation Score	32 points 1 slot(Input 22 points, output 10 points)				
	Clock	Synchronized at PLC CPU time whenever it is scanned				
	DC5V Internal Consumption Current	0.53A				
	External Size	98(H)[mm] x 27(W)[mm] x 90(D)[mm]				
	Weight	0.13kg				

## System Configuration

CSV File

	A	B	C	D
1	Time	Index	DWORD	WORD
2	2011/07/04/09:22:35.038	1807154	05701D3C	1D3C
3	2011/07/04/09:22:35.058	1807155	05701D3D	1D3D
4	2011/07/04/09:22:35.079	1807156	05701D3E	1D3E
5	2011/07/04/09:22:35.098	1807157	05701D3F	1D3F

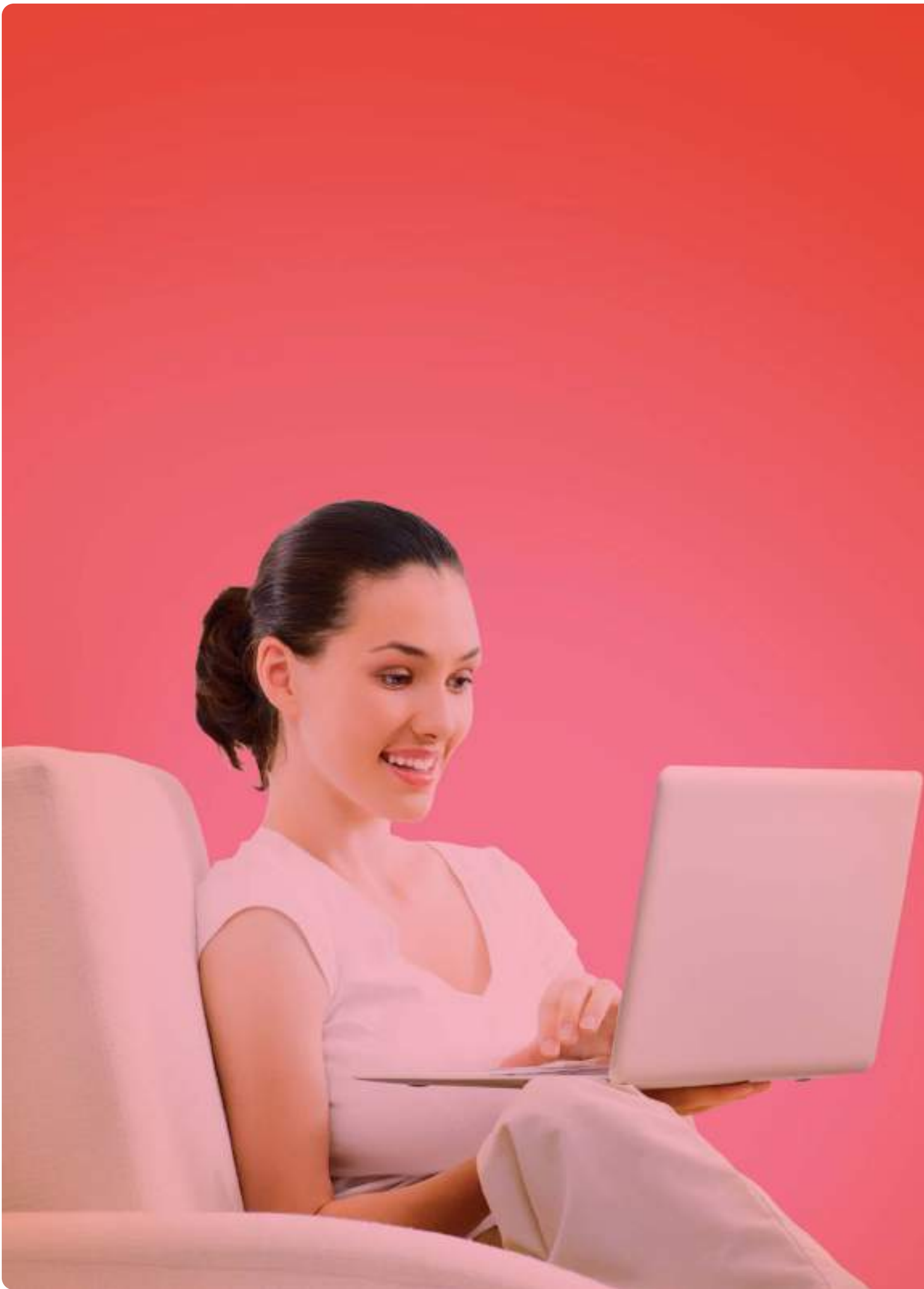





# Software

Software innovation for integrated solution.

**XG5000 is the optimum software which can cover various programming needs, debugging, and easy maintenance. Especially, XG5000 achieves customer satisfaction with useful maintenance tool by internet.**

Contents	122	XG5000 programming
	132	XG5000 Communication Parameters
	134	XGT Panel iXP Series
	135	XGT Panel XP Series
	138	APM[Positioning module] Software Package
	139	Product list
	141	Dimensions
	142	Worldwide Network

## Features



- Program editing & Engineering software
- Windows-based easy operation
- Multi-PLC, Multi-program, Multi-task in one project
- Various monitoring and diagnosis functions
- Windows 2000, XP, VISTA, Win7, Win8(32/64bits)  
(Limited use in Windows 98, ME)

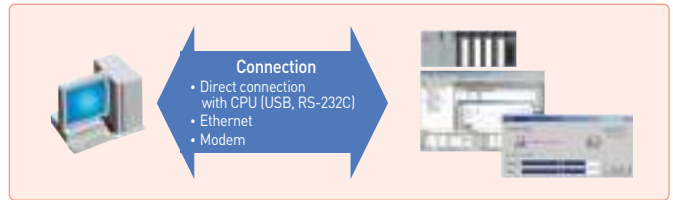
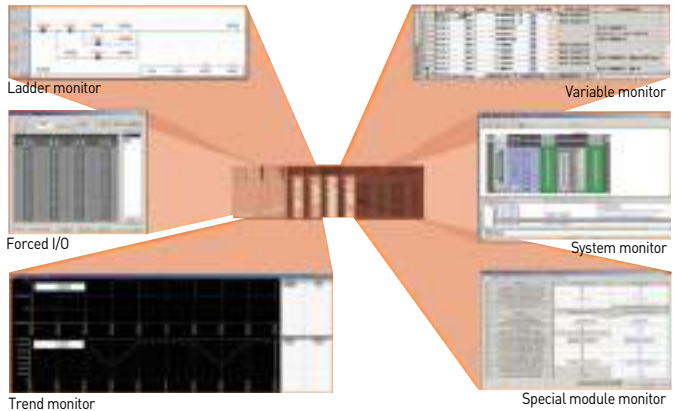

## Programming tools

**MPMP (Multi-PLC Multi-programming)**  
Different PLC systems can be edited, monitored, and managed simultaneously in one project.

**Drag & Drop**  
It is available in project, variable/comment, ladder diagram editing and monitoring.

**User-defined shortcut keys**  
User-defined shortcut keys increase editing convenience.

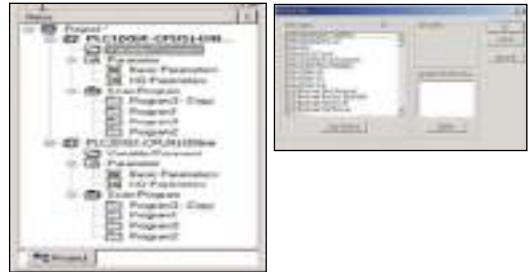

## Monitoring



**Special module monitoring**  
Monitoring and test-run of various special modules are available.



**Trend monitoring**  
The changing value of specific device can be monitored and saved as a file.



**System monitoring**

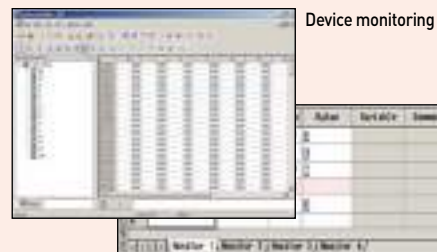

**Device monitoring**

**Variable monitoring**

### System requirement

Item	System requirement
O/S	Windows 2000, XP, VISTA, Win7, Win8(32/64bits) (Limited use in Windows 98, ME)
CPU	IBM compatible PC with Min. 200MHz Pentium processor
Memory	Min. 128M
HDD	100 MB (Free memory space)
Serial port	Communication port for program transmission (RS-232C, USB)
Printer	Compatible with Windows 98 or later
Mouse	Compatible with Windows 98 or later

### Variable and programming editing

- Data input like EXCEL
- Cell-unit edit
- Auto Fill function
- Compatible with Microsoft Excel
- Redo and Undo (Unlimited)
- Segment screen edit



### Improved diagnosis and maintenance



**Module exchange wizard**  
It supports safe module exchange during 'RUN' mode.



**User-defined event**  
By registering user-defined event, users can read the record of specified event and use it for PLC operation and debugging



**Forced I/O**  
The status of external output device can be checked without program. And when input device breaks down, forced input function specifies ON/OFF and can operate the system without interruption of equipment.



**I/O skip, Error Mask**  
I/O inspection and renewal can be set for specific module and continuous operation is available when an error is occurred.

## Program editing

- Start XG5000
- Select [New Project]
- Write project name and select CPU type

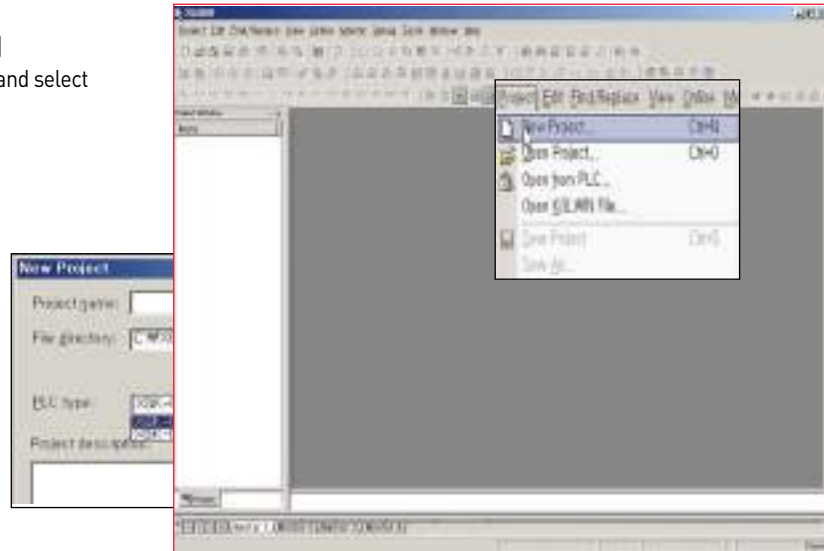

## Configure ladder lines as below with ladder input tool bar

- Select input point and command with ladder tool bar.

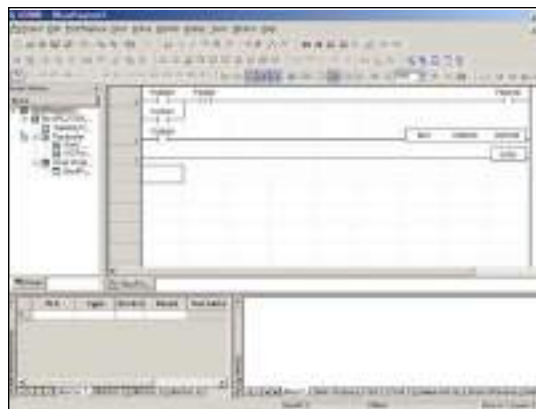

Icon	Description	Short key
	Arrow mode	ESC
	Normally open contact	F3
	Normally closed contact	F4
	Positive transition-sensing contact (On for 1 scan when Off → On)	Shift+F1
	Negative transition-sensing contact (On for 1 scan when On → Off)	Shift+F2
	Horizontal line	F5
	Vertical line	F6
	Fill horizontal line	Shift+F8
	Coil	F9
	NOT instruction contact	Shift+F9
	Negated coil	F11
	SET coil	Shift+F3
	RESET coil	Shift+F4
	Positive transition-sensing coil (On for 1 scan when Off → On)	Shift+F5
	Negative transition-sensing coil (On for 1 scan when On → Off)	Shift+F6
	Function	F10

## Note) Addition of 'EDGE' detection instructions

Develop user-friendly programming through adding D, D NOT instructions (Rising EDGE, dropping EDGE) to contact and output coil.

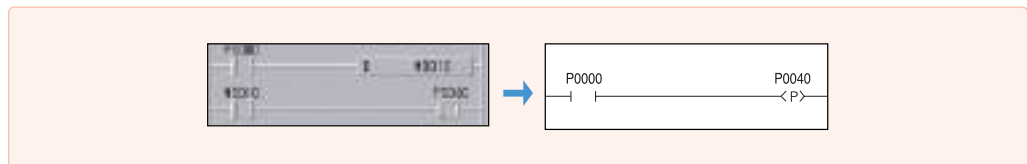

## Program download

### Connection setting

- Check a setting for connection between XGT and XG5000
- XGT supports USB and RS-232C

Set up communication port and download speed

\* using "USB TO RS-232C" converter, 115,200bps connection may be unavailable depending on characteristics of converter. In this case, change the communication speed to 38,400bps.

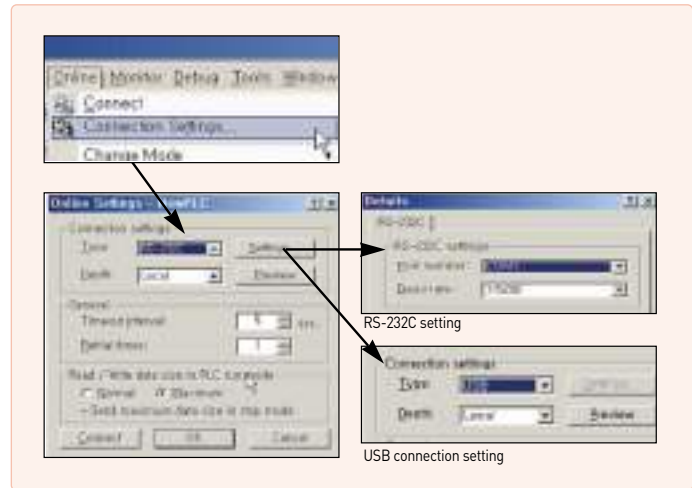

### Connection

Connect to PLC and download the program as below.

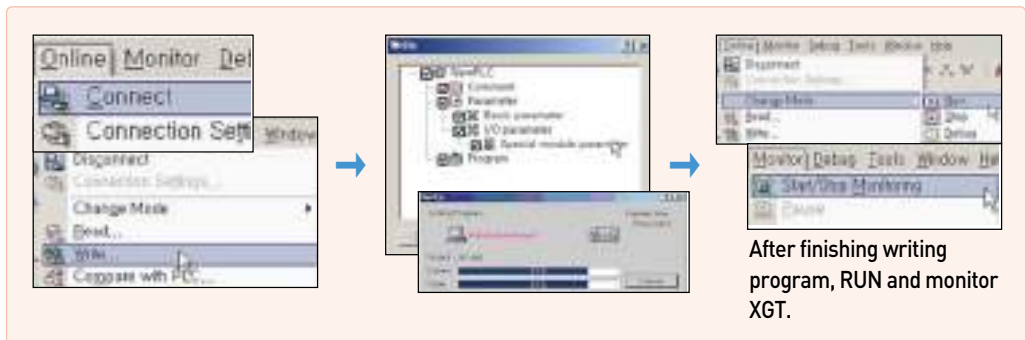

### Short icon

\* XGT doesn't support collective-writing monitoring for system safety.

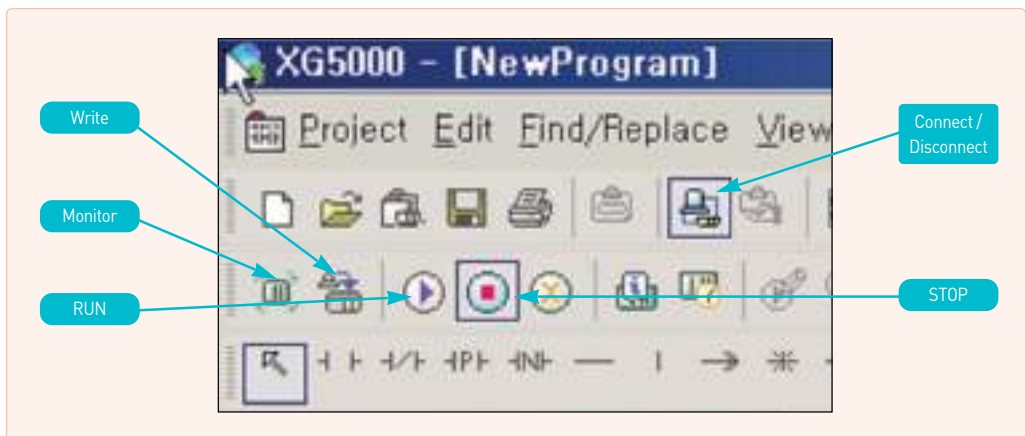

## Online Editing

Select [Start Online Editing] in Online menu.



When starting Online Editing, the screen color becomes blue.

Modify the program.

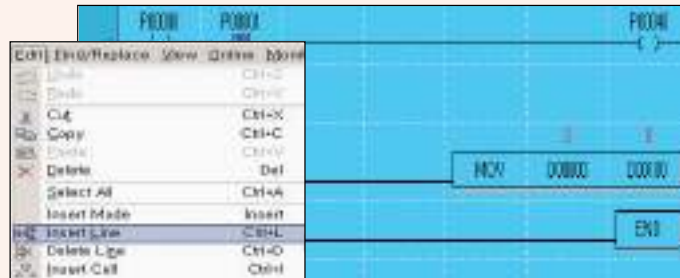

Edit menu

After finishing modifying the program, select [Write Modified Program] and [End Online Editing].

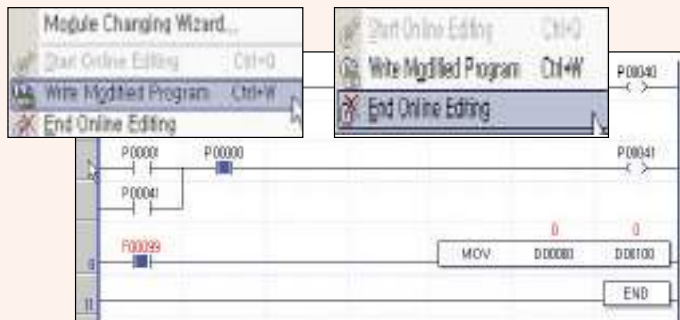

After finishing 'Online Editing'

**Open a project written in KGL-WIN**

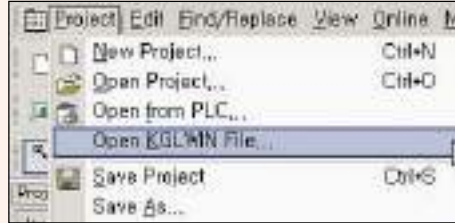

Select [Open KGLWIN file] in project.

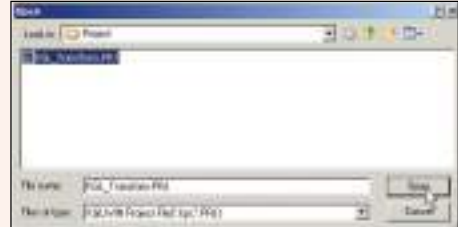

Select the file.



Select the type of XGT CPU.

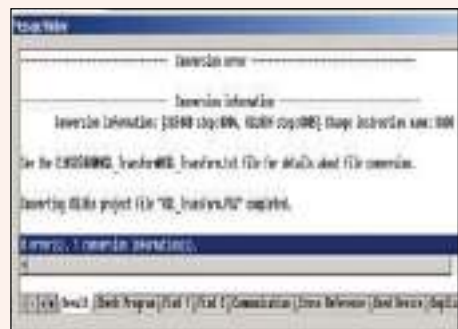

Check converted information in the message window.

**Note)** Dedicated instructions and special parameters for MASTER-K cannot be converted. Mostly General instructions and descriptions are converted. Information impossible to be converted is displayed as ERR.

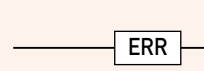

• Content of main special flag (F) change

MASTER-K	XGT	Specifications
F10	F99	ON regularly
F11	F9A	OFF regularly
F12	F9B	ON during first one scan
F13	F9C	OFF during first one scan

For more detailed information, refer to user's manual.

## Data type

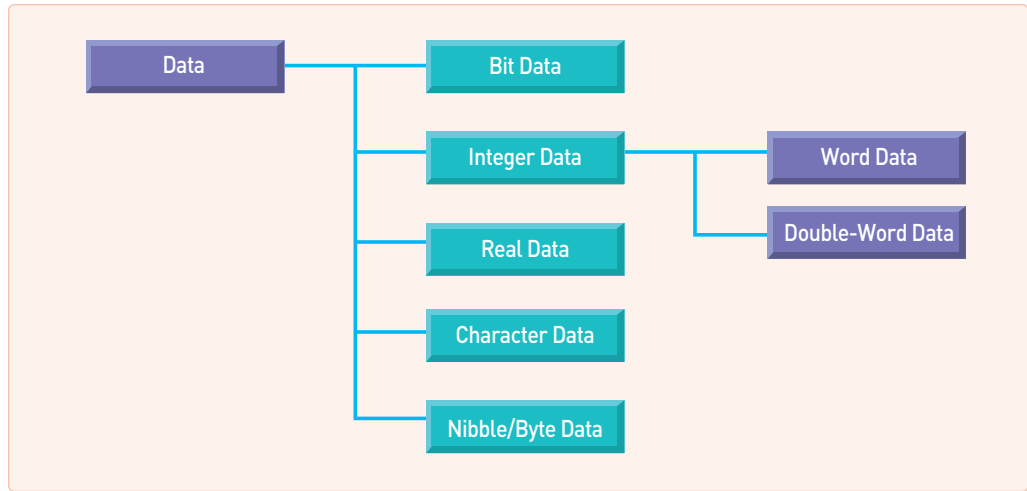

- Nibble: 4-bit unit data
- Byte: 8-bit unit data
- Real Data: 32-bit/64-bit floating point data

### Real Number

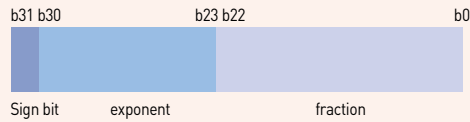

### Long Real Number

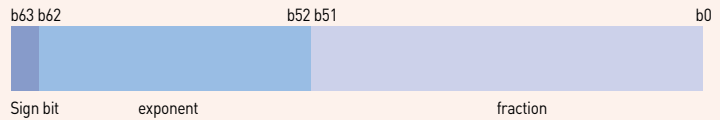

- Character Data: Saving numbers, alphabets, symbols as a type of ASCII code

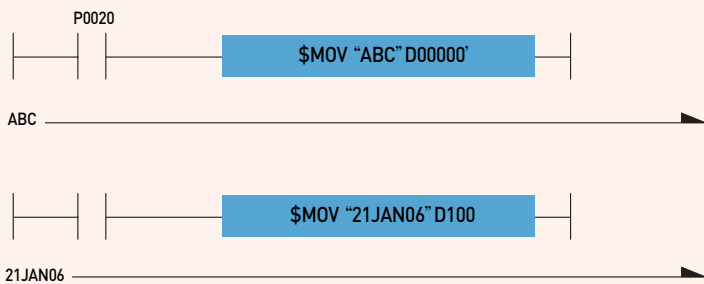

D100	0x31	0x32
D101	0x41	0x4A
D102	0x30	0x4E
D103	0x00	0x36
D104	0x00	0x36



## Device type

Device	Size	Bit Contact	Word Data	Name
P	32768 points	P00000 ~ P2047F	P0000 ~ P2047	I/O Relay
M	32768 points	M00000 ~ M2047F	M0000 ~ M2047	Assistant Relay
L	180224 points	L00000 ~ L11263F	L0000 ~ L11263	Link Relay
N *1)	21K words	N/A	N00000 ~ N21503	Comm. data register
K	32768 points	K00000 ~ K2047F	K0000 ~ K2047	Keep Relay
F	32768 points	F00000 ~ F2047F	F0000 ~ F2047	Special Relay
T *2)	2048 points	T0000 ~ T2047	T0000 ~ T2047	Timer
C *3)	2048 points	C0000 ~ C2047	C0000 ~ C2047	Counter
U	3072 words	U00.00.0 ~ U7F.31.F	U00.00 ~ U7F.31	Special Module Counter
Z	128 words	N/A	Z0 ~ Z127	Index Register
S	128 groups	S00.00 ~ S127.99	N/A	Step Control Relay
D	32K words	D00000.0 ~ D32767.F	D00000 ~ D32767	Data Register
R (Internal RAM) *4)	32K words	R00000.0 ~ R32767.F	R00000 ~ R32767	File Register
ZR (Internal RAM) *5)	32K words	N/A	ZR00000 ~ ZR65535	File Register
R (Expanded)	1M words	N/A	Available as much as extension size	File Register
ZR (Expanded)	1M words	N/A	Available as much as extension size	File Register

- Note)** 1. When communication module is not used, it can be used as internal data area.  
 2. Word data in timer shows a current value of relevant bit contact.  
 3. Word data in counter shows a current value of relevant bit contact  
 4. Even when using more than 32K words internal RAM, bit contact available to display is R00000.0~R32767.F Also word data enable to be displayed in the range of R00000.0~R32767.F  
 5. When internal RAM is more than 32K words, bit contact can be in the range of ZR00000.0~ZR32767.F and word data can be displayed as much as the size of internal RAM

## Special module register U

Register for reading data from special module mounted in slot

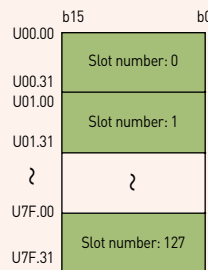

- Assigning 32 words per slot in U area
- Bit type display available  
Ex) U93.12.x (x: Bit location, Hexadecimal display)
- Available to read/write internal memory value of special module without using PUT (P), GET (P), PUTS (P), GETS (P)
- Basic display in U area  
Ex) Uxy.z  
x: Base number (0~7)  
y: Slot number (0~F)  
z: Word number of special module internal memory

## File register R, ZR

Register that a recorded value is not deleted when power failure is occurred. File register is used for data backup or data storage.

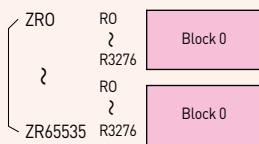

- R: Block unit access
- ZR: Entire file register access
- Internal RAM (Temporary preservation): 32K words
- FLASH (Permanent preservation): 1M words

## Index register

Index register sets up devices using index function.  
 The sum of index register value and directly specified device number is real device number.

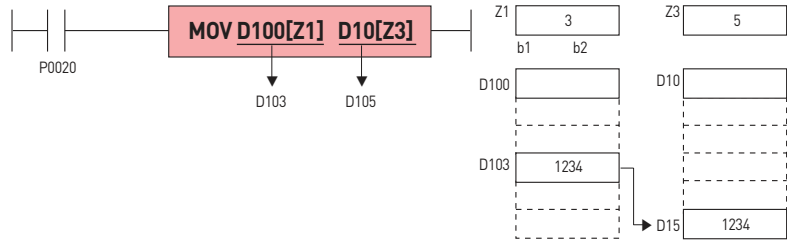

## Available Device

- Bit Device: P, M, L, K, F, T, C
  - Word Device: U, D, R, ZR, N, present value of T and present value of C
- Ex) MOV T1[Z1] D10 : If Z1 is 5, present value of T(1+5)=T6 is transmitted to D10.  
 Ex) LOAD D10[Z1].5 : If Z1 is 5, LOAD(10+5).5 => LOAD D15.5 is set.

## Bit specifying method of word device

By assigning bit number to word device, bit data is available to use.

Word device number · Bit number

In this case, word device number should be addressed as decimal and bit number should be addressed as hexadecimal.

Relevant Device: U, D, R

## Instructions

Classification	Designations	Symbol	Description	No. of step
16 Bits transfer	MOV	MOV S D	(S) → (D)	2
	MOVP	MOVP S D		3
32 Bits	DMOV	DMOV S D	(S+1,D) → (D+1,D)	3
	DMOVP	DMOVP S D	(S+3,S+2,S+1,S)	

① **Classification:** Classifies instructions into applications.

② **Designations:** Displays instruction names to be used in program.

- Display rules: Instructions shall be basically displayed in word unit. According to data size, operation characteristics, real number data process, text process, the rules are as follows;
- Based on Data Size & Type
  - D: Double Word related instruction.
  - R: Real Number related instruction.
  - L: Long Real Number related instruction.
  - However, LMOV is 64 Bits transfer instruction.
  - \$: String related instruction.
  - G: Group calculation.
  - 4: Nibble related instruction, used only at the back of instruction.
  - 8: Byte related instruction, used only at the back of instruction.
  - 3: Instruction that process 3 operands, used only at the back of instruction.
- Based on Operation Characteristics
  - P: Instruction that is executed for 1 scan when input signal is changed OFF => ON

③ **Symbol:** Displays symbols used in program, showing the number of used operands and the type of Source or Destination. Operand display rules are as follows;

- S: Source, with data value not changed after calculated.
- D: Destination, with data value changeable after calculated.
- N, n: The number to process.
- St, En: Start and End, used only in BSFT & WSFT.
- Sb: Source in case Bit position is specified, mostly used in Nibble/Byte instruction.
- Db: Destination in case Bit position is specified.
- Z: Control word, which means previously specified format as based on each instruction.

④ **Description:** Describes general functions of instruction.

⑤ **No. of step:** The number of basic steps of instruction, which means the number of steps in case indirect specification, index formula and direct variable input were not used.

## Features

- Default settings of the network and easy of user program
- Network system and provides extensive monitoring and control of the communication module
- Efficient implementation of a fast interface with the CPU to the network management
- Easy access with XGT and Modbus
- Rich built-in diagnostic function (Condition of CPU, Link, Auto SCAN, Frame monitor)



Item		RAPIDnet	FEnet	FDEnet	IFOS FEnet	Cnet	EtherNet/IP	Fnet	Rnet	DeviceNet	Profibus-DP	
Service	High speed link	○	○	○	○	–	–	○	○	○	○	
	XGT server protocol	–	○	–	○	○	–	–	–	–	–	
	Modbus server protocol	–	○	–	○	○	–	–	–	–	–	
	P2P	○	○	○	○	○	○	–	–	–	–	
	XG5000 Service	○	○	○	○	○	○	–	○	–	–	
High speed link	Max. station	64	64	64	64	–	–	64	64	64	126	
	No. of block	128	128	128	128	–	–	64	64	64	126	
	Send block	64	32	32	32	–	–	32	32	64	126	
	Receive block.	128-Send block				–	–	64-Send block	32	64	–	
	Data per block	200 words				–	–	60 words	256bytes	244bytes	–	
P2P	No. of block	64	64	64	64	64	–	–	–	–	–	
	Data per block	1400bytes				256bytes	–	–	–	–	–	
	Service	–	User defined, XGT client, Modbus client				–	–	–	–	–	
Ether Net/IP	TCP	–	–	–	–	–	64(Client) 128(Server)	–	–	–	–	
	CIO (IO Communication)	–	–	–	–	–	64(Client) 128(Server)	–	–	–	–	
System diagnosis		Connection status, network status										
Media		100Base-T/FX	10/100Base-T/FX		900~ 115200bps	100Base-T	1Mbps	125/250/500Kbps	9.6K-12Mbps			
Topology		Ring, Line	Star	Ring, Line	Bus	Star, Line	Bus	Bus, Star	Bus			
Configuration Tool		XG5000							XG5000 / N Configurator			

### Various network diagnosis and monitoring

- Auto Scan: Searching and displaying each node connected to network
- Link Monitor: Monitoring status of high-speed link communication of each station
- Frame Monitor: Collecting and displaying sending/receiving frame in real time



Item	RAPIEnet	FEnet	FDEnet	IFOS FEnet	Cnet	EtherNet/IP	Fnet	Rnet	DeviceNet	Profibus-DP
Module information	●	●	●	●	●	●	●	●	●	●
Media status	●	-	-	-	-	●	-	-	-	-
Auto scan	●	●	●	●	●	●	●	●	●	●
Ping test	-	●	●	●	-	-	-	-	-	-
Link monitoring	●	●	●	●	●	●	●	●	●	●
Frame monitoring	-	-	-	-	●	-	-	-	-	-

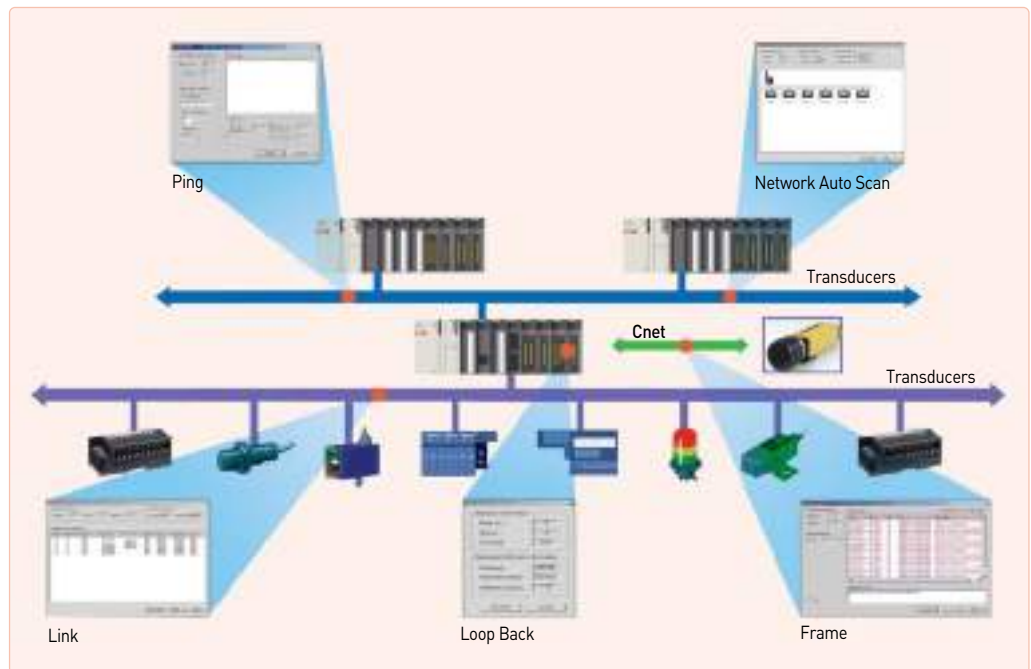

## Main Specification

- 1GHz 32bit RISC Embedded CPU
- Ethernet 1ch, RS-232C 2ch, RS-422/485 1ch
- 16,777,216 TFT color LCD
- USB host 3ch and device 1ch
- 128MB display data and 1MB back-up memory
- SD memory card interface

## Main Functions

- PLC ladder monitoring (XGK/XBC PLC only)
- Web Server/Data Server
- Path through
- XP-Remote : Remote controlling and monitoring



Item		iXP50-TTA/DC	iXP70-TTA/DC iXP70-TTA/AC	iXP80-TTA/DC iXP80-TTA/AC	iXP90-TTA/DC iXP90-TTA/AC
Display type		TFT color LCD			
Screen size		21.3cm (8.4")	26.4cm (10.4")	30.7cm (12.1")	38.1cm (15")
Display Resolution		800 × 600 pixel (SVGA)	800 × 600 pixel (SVGA)	800 × 600 pixel (SVGA)	1,024 × 768 pixel (SVGA)
Color indication		16-bit and 24-bit Color (default: 16-bit Color)			
Indication degree		Left/Right: 80 deg. Up: 80 deg. Down: 60 deg.		Left/Right: 80 deg. Up: 60 deg. Down: 80 deg.	
Backlight		LED Type			
Backlight duration		70,000 hours		60,000 hours	
Brightness		500 cd/m <sup>2</sup>	700 cd/m <sup>2</sup>	550 cd/m <sup>2</sup>	800 cd/m <sup>2</sup>
Touch panel		4-Line type, analog			
Sound Output		Magnetic buzzer (85dB)			
Process		ARM Cortex-A8 Core (32bit RISC), 1GHz			
Memory	Flash	512MB (display 128MB)		1GB (display 128MB)	
	Operating RAM	256MB		512MB	
	Backup RAM		1MB		
Backup data		Date/Hour data, Logging/Alarm/Recipe data and nonvolatile device			
Battery duration		Approx. 3 years (Operating ambient temperature of 25°C)			
Ethernet		1 channel, 10/100BASE-TX			
USB Host		3 channels, USB 2.0 host (mouse, keyboard, printer* and USB memory driver is available) 1 channel, USB 2.0 slave (for download and upload project file)			
RS-232C		1 channel			
RS-422/485		1 channel, RS-422/485 mode			
SD Card		1 Slot (SDHC)			
Human sensor		-	Detection range: side 1-1.5m, front 40-50cm Angle: high/low 100°, left/right 140° (detecting 5-20 micron infrared light)		
Audio output		LINE-OUT 1 channel			
Expansion module		For communication and I/O option module (available later)			
VM module		-	4 channels video input (available later)		
Multi-language		Up to 12 language simultaneously			
Animation		GIF format is available			
Recipe		available			
Data logging		available			
Script executor		available			
Certifications		CE, UL (cUL), KC			
Protection standard		IP65			
Dimension (mm)		240.5 × 180.0 × 54.4	270.5 × 212.5 × 60.0	313.0 × 239.0 × 56.0	395.0 × 294.0 × 60.0
Panel cut (mm)		228.5 × 158.5	259.0 × 201.0	301.5 × 227.5	383.5 × 282.5
Rated voltage		DC24V	DC12/24V (AC 100-240V)		
Power consumption (W)		30.8	42.3	42.3	42.3
Weight (Kg)		1.9	2.2	2.4	3.9

\* SEWOO printer only

## Main Specification

- TFT LCD-applied wide type
- LED Backlight adopted for enhanced contrast ratio and low-power
- PLC Ladder monitoring function: Only XGK/XBC supports\*
- Web Server\* / Data Server\* / Path-Through Function\*
- Remote Viewer Function\*
- Screen editor : XP-Builder

\* Functions that support only the TTA model



Item		eXP20-TTA/DC	eXP40-TTE/DC	eXP40-TTA/DC	eXP60-TTA/DC
Display Type		TFT color LCD			
Display Size		10.9cm (4.3 inch)	17.7cm (7 inch)		25.9cm (10.2 inch)
Resolution		480 x 272 (WQVGA)	800 x 480 (WVGA)		
Color		16.7M colors			65,536 colors
Display Angle		Left/Right: 60 deg. Up: 40 deg. Down: 60 deg.			Left/Right: 55 deg. Up: 35 deg. Down: 55 deg.
Backlight		LED mode, Auto On/Off			
Backlight Capacity		30,000 hr or more	20,000 hr or more		
Brightness(LCD)		550 cd/m <sup>2</sup>	500 cd/m <sup>2</sup>		350 cd/m <sup>2</sup>
Touch Panel		4-wire system, Analogue			
Sound		Magnetic buzzer (85dB)			
Processor		ARM9 Core (32bit RISC), 454MHz			
Memory	Flash	128MB(Screen 64MB)			
	Operation RAM	128MB			
	Backup RAM	128KB			
Backup Type		Date/Time data, Logging/Alarm/Recipe data, non-volatile device			
Battery Capacity		Around 3 years (Upon operation at 25°C)			
RTC Function		Built-in			
Ethernet		1 channel, 10/100BASE-TX	-	1 channel, 10/100BASE-TX	
USB Port		1 channel, USB 2.0 host (mouse, keyboard, printer* and USB memory driver is available)			
		-	1 channel, USB 2.0 slave (for download and upload project file)		
RS-232C		1 channel			
RS-485		-	1 channel		
RS-422/485		1 channel, 422/485 Combination			
Multi-language		Up to 12 language simultaneously			
Animation		GIF format is available			
Recipe		available			
Data logging		available			
Script executor		available			
Certification		CE, UL(cUL), KC			
Protection		IP65			
Size (mm)		128.0×102.0×32.0	208.0×154.0×44.0		276.0×218.0×44.2
Panel Cut (mm)		119.0×93.0	192.0×138.0		260.0×202.0
Power		DC24V			
Power Consumption (W)		7.1	23.1		
Weight (kg)		0.3	0.59	0.60	1.0

\* SEWOO printer only

## Graphic type XP30/XP40/XP50/XP70/XP80/XP90

- High and vivid distinction with 65,536 colors
- High quality raster and vector symbols
- Various BMP JPG GIF graphic file support: BMP, JPG, GIF, WMF, etc
- Simple animation effects: animated GIF
- 10/100BASE-T Ethernet interface
- Convenient and easy screen editing
- Strengthened data management: Logging, Recipe, and Alarm
- Read function of a controller's state information: Monitoring and maintenance
- Multi-lingual display: up to 8 languages
- Offline and concurrent simulation with XG5000
- Easy to change the address of the graphic objects: Tag function with XGT Panel
- USB host for peripheral devices: USB Drive, Mouse, keyboard, printer, etc
- Sufficient memory for screen data: 10MB



Model Type	XP30-BTE/DC	XP30-BTA/DC	XP30-TTE/DC	XP30-TTA/DC	XP40-TTE/DC	XP40-TTA/DC	XP50-TTA/DC	XP70-TTA/AC XP70-TTA/DC	XP80-TTA/AC XP80-TTA/DC	XP90-TTA/AC			
	Mono				Color								
Display Element	Mono Blue LCD				TFT Color LCD								
Screen Size	14cm (5.7")				17.7cm (7")		21cm (8.4")	26cm (10.4")	31cm (12.1")	38cm (15")			
Resolution	320×240				800×480		640×480		800×600	1024×768			
Color	8-column Gray Scale		256 colors	65,536 colors		65,536 colors							
Backlight	LED mode				CCFL(can be replaced), Auto On/Off								
	50,000 hours			60,000 hours		30,000 hours		50,000 hours			60,000 hours		
Contrast	Adjustable			Fixed									
Brightness	230cd/m <sup>2</sup>			600cd/m <sup>2</sup>	280cd/m <sup>2</sup>		480cd/m <sup>2</sup>	430cd/m <sup>2</sup>	400cd/m <sup>2</sup>	450cd/m <sup>2</sup>			
Viewing Angle	Up/Down(Degree)		80/80		70/70		50/60		45/65	45/75	60/50		
	Left/Right(Degree)		45/45		80/80		65/65		65/65	65/65	75/75		
Touch Panel	4-wire system, analogue				Analog resistive			8-wire system, analogue					
Movement LED	Green: Normal RUN (Monitoring & drawing data download) Red: Error (Communication error & drawing data error)												
Memory	Screen Data	4MB	10MB	4MB	10MB	4MB	10MB	10MB		20MB			
	Backup Data	128KB	512KB	128KB	512KB	128KB	512KB		512KB				
Ethernet	-	1ch, 10/100Base-T	-	1ch, 10/100Base-T	-	1ch, 10/100Base-T		1ch, 10/100Base-T					
USB Interface	USB Host X 1	USB Host X 2	USB Host X 1	USB Host X 2	USB Host X 1		USB Host X 2						
Serial	RS-232C	2ch(1 port for PC communication)											
	RS-422/485	1ch, 422/485 optional mode											
CF Card Interface	-	CF card (TAPE-1)×1	-	CF card (TAPE-1)×1	-		CF card (TAPE-1)×1						
AUX Interface	-	Optional	-	Optional	-		Optional						
Certification	CE, UL, KC												
Protection	IP65 (Front Water Proof Structure)												
Size(W×H×D)mm	181 x 140 x 56.5	181 x 140 x 66.5	181 x 140 x 56.5	181 x 140 x 66.5	203.5 x 153.5 x 41.5		240 x 174 x 73	317 x 243 x 73		395 x 294 x 73			
Panel Cut (W×H)mm	155.0 x 123.5				192 x 138		228.5 x 158.5	294.5 x 227.5		383.5 x 282.5			
Weight (kg)	0.62	0.75	0.62	0.75	2.2	2.4	1.4	2.2	2.4	3.9			
Power	Rated Voltage	DC 24V							AC100-220V, DC 24V		AC100-220V		
	Permitted Voltage	AC	-							MIN 85 VAC, MAX 264 VAC			
		DC	MIN 19.2 VDC, MAX 28.8 VDC										
	Power Consumption(W)	AC	-							21.8	31.9	31.9	
DC		9.7	16.9	9.6	17.4	9.8	9.8	18.7	20.1	25.7	-		



## Text type XP10

- Screen: 192×64 Graphic STN LCD
- System RAM: 1000 words
- Flash memory: Program/Parameter back up
- Communication: Half-duplex comm.
  - Baud rate: 1200~115200 bps
  - Master/slave setting available
  - RS-232C/RS-485 2 CH separate to use
- Power requirements - 24 V input or 5 V direct input by LS PLC
- Various function key - ESC, ALM, SET, ENT, F1-F4, Arrow keys
- Panel Editor - Easy programming and H/W setting

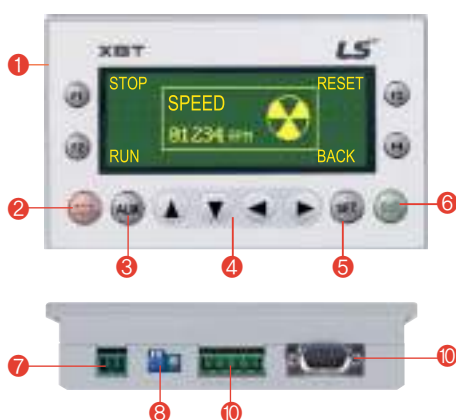

- 1 Key to control PLC device and screen
- 2 ESC key
- 3 Alarm history
- 4 Data input and Screen change
- 5 PLC data setting
- 6 Enter key
- 7 DC24V input terminal
- 8 RS-232C port to download a project
- 9 Brightness adjustment
- 10 RS-422 port

Item		Specifications	
		XP10BKA/DC	XP10BKB/DC
Input voltage	5VDC	DC 4.9 - 5.1 (RS-232C port)	
	24VDC	DC 21.6 - 26.4 (DC Input connector)	
	Consumption current	Less than 200mA	
Display		LED back-light (192 x 64 Dots)	
Communication interface		RS-232C, RS-422/485	
Flash memory		256K bytes	
Language		Default: English, Can be switched to Korean/Chinese/Russian	
RTC		None	Supports
Download specification		115,200bps	
Keys		12 Keys (F1-F4, ESC, ALM, ▲, ▼, ◀, ▶, SET, ENT)	

## Features

- Windows-based easy operation
- Supporting all types of LS APM module
- Improved parameter editing (Copy, Paste, Initialization, etc.)
- Various monitoring (Operation type of each axis, etc.)
- Profile trace and operation monitoring
- Profile graph and simulation of circular interpolation
- Available to edit operation parameter in EXCEL

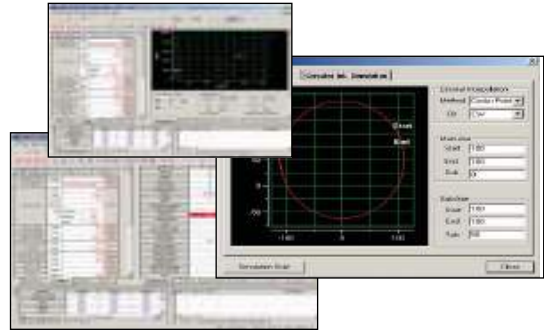

No.	Def.	Data	Rate	Method	Search/Stop	YCA	YB	Search/Stop	YCA	YB	Search/Stop	YCA	YB
1	XY	100	100	100	100	100	100	100	100	100	100	100	100
2	XY	100	100	100	100	100	100	100	100	100	100	100	100
3	XY	100	100	100	100	100	100	100	100	100	100	100	100
4	XY	100	100	100	100	100	100	100	100	100	100	100	100
5	XY	100	100	100	100	100	100	100	100	100	100	100	100
6	XY	100	100	100	100	100	100	100	100	100	100	100	100
7	XY	100	100	100	100	100	100	100	100	100	100	100	100
8	XY	100	100	100	100	100	100	100	100	100	100	100	100
9	XY	100	100	100	100	100	100	100	100	100	100	100	100
10	XY	100	100	100	100	100	100	100	100	100	100	100	100
11	XY	100	100	100	100	100	100	100	100	100	100	100	100
12	XY	100	100	100	100	100	100	100	100	100	100	100	100

**Operation Data**

Define operation method, target location, operation speed of each axis.



**Profile simulation (Off-line)**

Monitoring operation speed of each axis with graph type and saving result as image file.

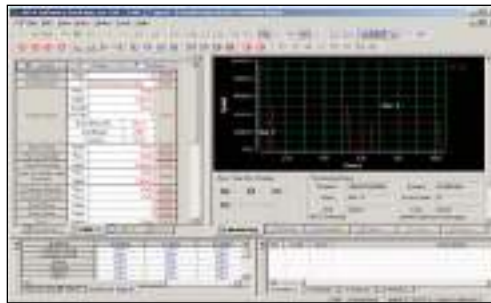

**Profile Trace (On-line)**

Monitoring operation speed of each axis with graph type and saving result as image file.



**Operation parameter**

Setting basic operation characteristics and limit value.



**Monitoring (On-line)**

Checking basic operation characteristics about each axis and monitoring operation condition.

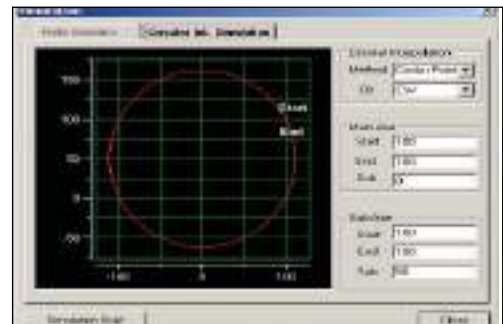

**Circular interpolation simulation (Off-line)**

## CPU / PWR / Base / I/O

CPU	XGK-CPUH,* CPUU, CPUHN, CPUUN	6,144pt, Program memory : 64Ksteps
	XGI-CPUS,* CPUA, CPUSN	3,072pt, Program memory : 32Ksteps
	XGK-CPUE*	1,536pt, Program memory : 16Ksteps
	XGI-CPUUN, CPUU/D, CPUU, CPUH*	9,144pt (IEC type), Program memory:1Mbyte
	XGI-CPUS*	3,072pt (IEC type), Program memory:128kbyte
	XGI-CPUE*	1,536pt (IEC type), Program memory:64kbyte
Power	XGP-ACF1*	Free Voltage/DC5V 3A, DC24V 0.6A
	XGP-ACF2*	Free Voltage/DC5V 6A
	XGP-AC23*	220V/DC5V 8.5A
	XGP-DC42*	DC24V/DC5V 6A
Main base	XGB-M04A*	4 Slot
	XGB-M06A*	6 Slot
	XGB-M08A*	8 Slot
	XGB-M12A*	12 Slot
Expansion base	XGB-E04A*	4 Slot
	XGB-E06A*	6 Slot
	XGB-E08A*	8 Slot
	XGB-E12A*	12 Slot
Input	XGI-A12A	AC110V, 16pt
	XGI-A21A	AC220V, 8pt
	XGI-A21C	AC 220V Input, 8pt(1COM)
	XGI-D21A	DC24V, 8pt
	XGI-D22A*	DC24V, 16pt, Sink/Source
	XGI-D22B	DC24V, 16pt, Source
	XGI-D24A*	DC24V, 32pt, Sink/Source
	XGI-D24B	DC24V, 32pt, Source
	XGI-D28A*	DC24V, 64pt, Sink/Source
	XGI-D28B	DC24V, 64pt, Source
Output	XGQ-RY1A	Relay, 8pt
	XGQ-RY2A*	Relay, 16pt
	XGQ-RY2B	Relay, 16pt, Surge killer
	XGQ-SS2A	Triac, 16pt
	XGQ-TR1C	Transist, 8pt(2A, 1COM)
	XGQ-TR2A*	Transist, 16pt, Sink
	XGQ-TR2B	Transist, 16pt, Source
	XGQ-TR4A*	Transist, 32pt, Sink
	XGQ-TR4B	Transist, 32pt, Source
	XGQ-TR8A*	Transist, 64pt, Sink
XGQ-TR8B	Transist, 64pt, Source	
Input/output	XGH-DT4A*	DC24V 16pt, Transist, 16pt, Sink

\* : G3 Coating Products

## Special module

Analog input	XGF-AV8A*	Voltage, 8ch
	XGF-AC8A*	Current, 8ch
	XGF-AD8A*	Voltage /Current, 8ch
	XGF-AD16A*	Insulation Voltage /Current, 16ch
	XGF-AD4S*	Voltage /Current, 4ch
Analog output	XGF-AW4S*	2-wire, Voltage/ Current input, 4Ch (Isolated)
	XGF-DV4A*	Voltage, 4ch
	XGF-DC4A*	Current, 4ch
	XGF-DV8A*	Voltage, 8ch
Analog input/output	XGF-DC8A*	Current, 8ch
	XGF-DV4S*	Voltage, 4ch, Insulation
	XGF-DC4S*	Current, 4ch, Insulation
HART I/F Analog input/output	XGF-AH6A*	Input: 4ch, Voltage/ Current Output: 2Ch Voltage/ Current
High speed counter	XGF-AC4H	Input: 4ch
	XGF-DC4H	Output: 4Ch
Positioning	XGF-H02A*	Open collector, 2ch
	XGF-HD2A*	Line drive, 2ch
	XGF-H08A*	8-channels high speed counter module, 8Ch
Positioning (Network type)	XGF-P01A-P03A	Open collector, 1~3axis
	XGF-PD1A-PD3A	Line drive, 1~3axis
	XGF-P01H-P04H	Open collector, 1~4axis
	XGF-PD1H-PD4H	Line drive, 1~4axis
Motion control	XGF-PN8A	LSIS EtherCAT Network, 8axis
	XGF-PN8B	Standard EtherCAT Network, 8axis
Temperature input	XGF-PN4B	Standard EtherCAT Network, 4axis
	XGF-M16M	MECHATROLINK-II, 4axis
	XGF-M32E	Standard EtherCAT, 32axes
Temperature controller	XGF-RD8A	RTD, 8ch
	XGF-RD4A*	RTD, 4ch
	XGF-RD4S*	RTD, 4ch, Insulation
	XGF-TC4S*	Thermo couple, 4ch, Insulation
Event input	XGF-TC4UD	Input: 4Ch(Voltage/Cuttent/RTD/TC) Output: 8Ch(TR/Current) 4loops
	XGF-TC4RT	Input:4Ch(RTD) Output: 4Ch(TR) 4loops
Datalog	XGF-S0EA	DC24V, 32points
Datalog	XGF-DL16A	USB 2.0, CF2001, Max. 16Gbyte, 32points(input 22points, output 10points)

\* : G3 Coating Products

## Communication module

RAPIEnet	XGL-EIMT	RAPIEnet Twisted pair
	XGL-EIMH	RAPIEnet Twisted pair/ Fiber
	XGL-EIMF	RAPIEnet Fiber optic 2ch
	XGL-ES4T	RAPIEnet Switch, 4Ports
	XGL-EIMT	RAPIEnet Twisted pair 2ch
	XGL-EIMF	RAPIEnet Fiber optic 2ch (PC)
Cnet	XGL-CH2B*	RS-232C/RS-422
	XGL-C22B*	RS-232C, 2ch
	XGL-C42B	RS-422, 2ch
Ethernet	XGL-EFMFB*	Fiber optic, Master, SC type
	XGL-EFMTB*	Twisted pair, Master, RJ-45
	XGL-EHST	Fast Ethernet switch hub
Ethernet/IP	XGL-EIPT	Industrial Ethernet, 2ports
Dedicated	XGL-EDMF	Fiber optic, Dedicated
	XGL-EDMT	Ethernet Twisted pair, Dedicated Ethernet
Rnet	XGL-RMEB*	Rnet, Master
Dnet	XGL-DMEB*	DeviceNet, Master
Pnet	XGL-PMEB*	Profibus-DP, Master
	XGL-PSRA	Profibus-DP, Slave, Remote Interface
	XGL-PSEA	Profibus-DP, Slave I/F system(I/O slot)
Fnet	XGL-FMEA	Dedicated network
BACnet/IP	XGL-BIPT	BACnet client/server

\* : G3 Coating Products

## XGR module

CPU	XGR-CPUH/T*	Twisted pair
	XGR-CPUH/F	Fiber optic(2km)
	XGR-CPUH/S	Fiber optic(15km)
INC	XGR-INCT	Twisted pair
	XGR-INCF	Fiber optic
Power	XGR-AC12*	110V, 5.5A(Main base)
	XGR-AC13*	110V, 8.5A(Expansion base)
	XGR-AC22*	220V, 5.5A(Main base)
	XGR-AC23*	220V, 8.5A(Expansion base)
	XGR-DC42*	DC24V/DC5V 7A, Main(Expansion base)
Base	XGR-M06P*	6Slot(Main base)
	XGR-M02P*	2Slot(Main base)
	XGR-E08P	8Slot(Expansion base)
	XGR-E12P*	12Slot(Expansion base)
	XGR-E12H*	12Slot(Expansion base, Drive Redundancy)
Expansion drive	XGR-DBST*	Twisted pair - Twisted
	XGR-DBSF*	Pair Fiber optic - Fiber optic(2km)
	XGR-DBSH*	Twisted pair - Fiber optic(2km)
	XGR-DBSFS	Pair Fiber optic - Fiber optic(15km)
	XGR-DBSHS	Twisted pair - Fiber optic(15km)
Expansion drive redundancy	XGR-DBDT	Twisted pair - Twisted
	XGR-DBDF	Pair Fiber optic - Fiber optic(2km)
	XGR-DBDH	Twisted pair - Fiber optic(2km)

\* : G3 Coating Products

## Cable

CPU	Product	Description
Expansion cable	XGC-E041	0.4m
	XGC-E061	0.6m
	XGC-E121	1.2m
	XGC-E301	3.0m
	XGC-E501	5.0m
	XGC-E102	10m
	XGC-E152	15m
Termination connector	XGT-TERA	Termination connector for expansion base download cable
USB cable	USB-301A	USB download cable
RS232C cable	K1C-050A	RS232C download cable
Sync & Expansion cable	XGC-F201	2m (Fiber optic)
	XGC-F501	5m (Fiber optic)
Dummy	XGT-DMMA	Dummy module
	XGR-DMMA	Dummy module

## Dimensions

• Base

• Power module

• CPU and I/O module

**Base Dimensions (W)**

Item	XGB-M04A/E04A	XGB-M06A/E06A	XGB-M08A/E08A	XGB-M12A/E12A
A	190	244	298	406
B	210	264	318	426

• Base base

• Expansion base

• Power and CPU

• I/O

**Base Dimensions (W)**

Item	XGR-M06P	XGR-E08P	XGR-E12P
A	333	353	461
B	346	373	481

# Worldwide Network

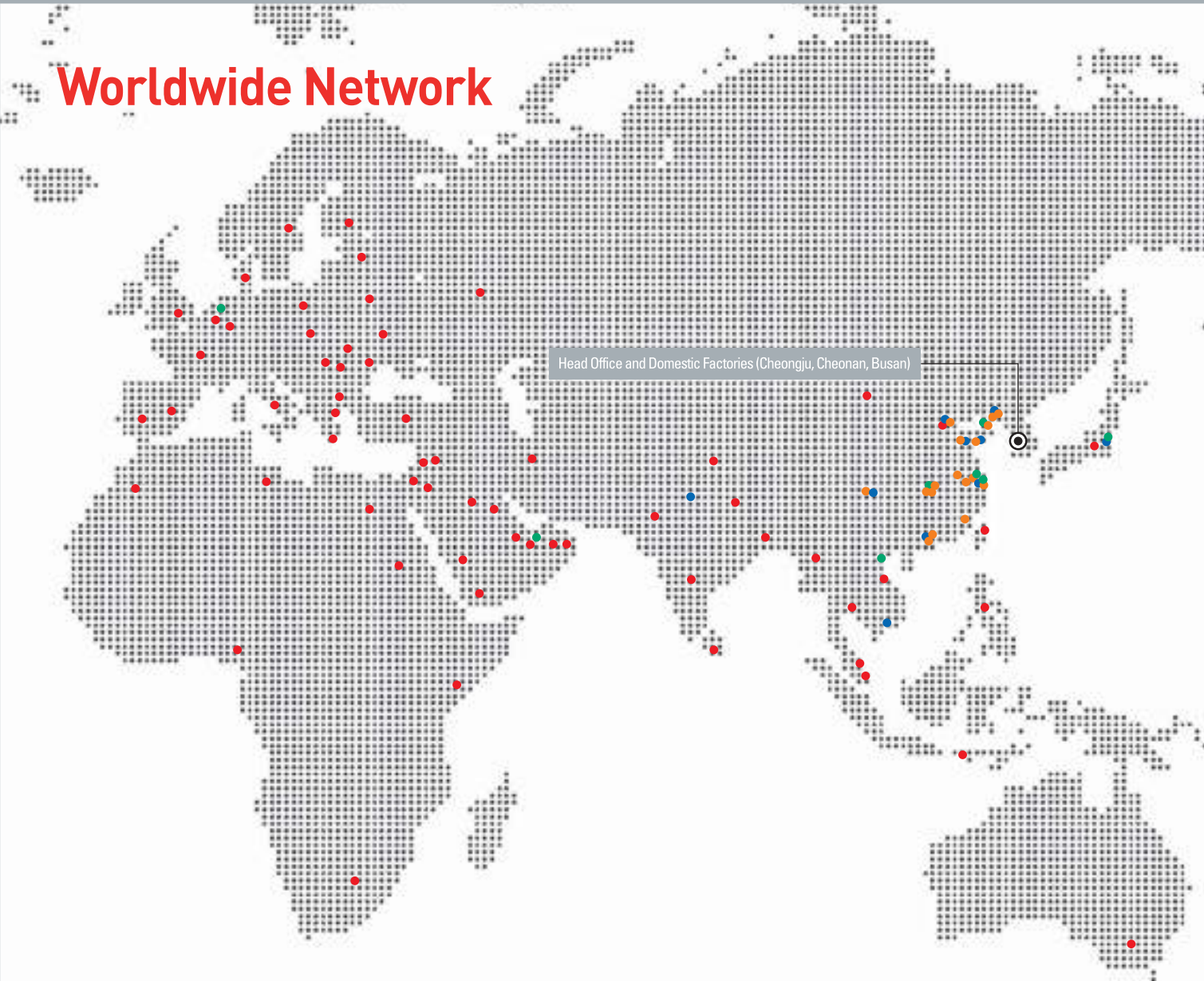

Head Office and Domestic Factories (Cheongju, Cheonan, Busan)

## Domestic Factories

- **Head Office**  
LS Tower, 127, LS-ro, Dongan-gu, Anyang-si, Gyeonggi-Do, 431-848, Korea  
Tel : 82-2-2034-4870 Fax : 82-2-2034-3660-7021
- **Cheongju Factory**  
1 Songjeong-dong, Cheongju-si, Chungbuk-do, 361-720, Korea  
Tel : 82-43-261-6114 Fax : 82-43-261-6602
- **Cheonan Factory**  
56, Samseong 4-gil, Mokcheon-eup, Dongnam-gu, Cheonan-si, Chungcheongnam-do, 31226, Republic of Korea  
Tel : 82-41-550-8114 Fax : 82-41-566-8408
- **Busan Factory**  
1-19 Block Hwajeon-dong, Gangseo-gu, Busan, 618-280, Korea  
Tel : 82-51-795-6114 Fax : 82-51-795-6169

## Overseas Factories

- **Wuxi Factory, CHINA**  
102-A, National High & New Tech Industrial Development Area, Wuxi, Jiangsu, 214028, P.R. China  
Tel : 86-510-8534-6666 Fax : 86-510-8534-4078
- **Dalian Factory, CHINA**  
No. 15, Liaohexi 3-Road, Economic and Technical Development zone, Dalian 116600, China  
Tel : 86-411-273-7777 Fax : 86-411-8730-7560
- **Hanoi Factory, VIETNAM**  
Room 1311, 13th Floor, M3-M4 Building 91 Nguyen Chi Thanh street, Hanoi, Vietnam.  
Tel : 84-4-6275-8055 Fax : 84-4-6275-8056

## R&D Center

- **R&D Campus in Anyang**  
40, LS-ro 116beon-gil, Dongan-gu, Anyang-si, Gyeonggi-do, 14118, Korea  
Tel: 82-31-8090-7011
- **Electric Technology R&D Center in Cheongju**  
95, Baekbong-ro, Heungdeok-gu, Cheongju-si, Chungcheongbuk-do, 28439, Korea  
Tel: 82-43-261-6114
- **Automation R&D Center in Cheonan**  
56, Samseong 4-gil, Mokcheon-eup, Dongnam-gu, Cheonan-si, Chungcheongnam-do, 31226, Korea  
Tel: 82-41-550-8272
- **Power Testing & Technology Institute in Cheongju**  
95, Baekbong-ro, Heungdeok-gu, Cheongju-si, Chungcheongbuk-do, 28439, Korea  
Tel: 82-43-261-6114



Cheongju Factory



Wuxi Factory (China)



Cheonan Factory



Dalian Factory (China)



Busan Factory



Hanoi Factory (Vietnam)

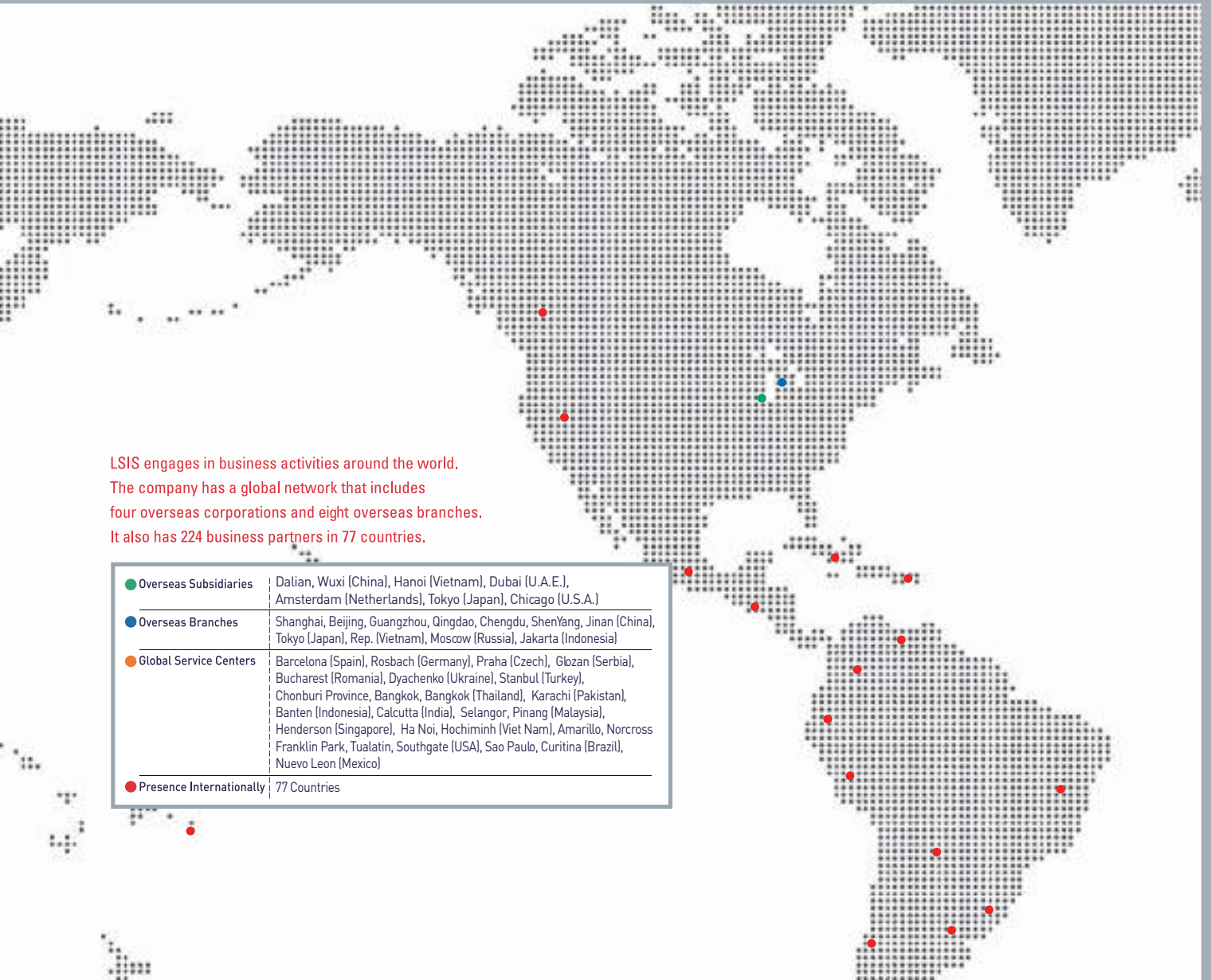

LSIS engages in business activities around the world.  
 The company has a global network that includes  
 four overseas corporations and eight overseas branches.  
 It also has 224 business partners in 77 countries.

● Overseas Subsidiaries	Dalian, Wuxi (China), Hanoi (Vietnam), Dubai (U.A.E.), Amsterdam (Netherlands), Tokyo (Japan), Chicago (U.S.A.)
● Overseas Branches	Shanghai, Beijing, Guangzhou, Qingdao, Chengdu, ShenYang, Jinan (China), Tokyo (Japan), Rep. (Vietnam), Moscow (Russia), Jakarta (Indonesia)
● Global Service Centers	Barcelona (Spain), Rosbach (Germany), Praha (Czech), Głozan (Serbia), Bucharest (Romania), Dyachenko (Ukraine), Stanbul (Turkey), Chonburi Province, Bangkok, Bangkok (Thailand), Karachi (Pakistan), Banten (Indonesia), Calcutta (India), Selangor, Pinang (Malaysia), Henderson (Singapore), Ha Noi, Hochiminh (Viet Nam), Amarillo, Norcross Franklin Park, Tualatin, Southgate (USA), Sao Paulo, Curitiba (Brazil), Nuevo Leon (Mexico)
● Presence Internationally	77 Countries

## Overseas Subsidiaries

- **LSIS(Dalian) Co., Ltd., Dalian, China**  
 No. 15, Liaohexi 3-Road, Economic and Technical Development Zone, Dalian 116600, China  
 Tel: 86-411-8730-7510 Fax: 86-411-8730-7560 E-Mail: jiheo@lsis.com
- **LSIS(Wuxi) Co., Ltd., Wuxi, China**  
 No. 1, Lexing Road, Wuxi National High & New Tech Industrial Development Area, Wuxi214028, Jiangsu, P.T.China  
 Tel: 86-510-8534-6666-8005 Fax: 86-510-8534-4078 E-Mail: sunhwank@lsis.com
- **LS-VINA Industrial Systems Co., Ltd., Hanoi, Vietnam**  
 Nguyen Khe, Dong Anh, Hanoi, Vietnam  
 Tel: 84-4-6275-8055 Fax: 84-4-3882-0220 E-Mail: hjchoid@lsis.com
- **LSIS(ME) FZE\_Dubai, U.A.E.**  
 LOB 19-205, JAFZA View Tower, Jebel Ali Free Zone, Dubai, United Arab Emirates  
 Tel: 971-4-886-5360 Fax: 971-4-886-5361 E-Mail: jungyong@lsis.com
- **LSIS Europe B.V., Netherlands**  
 1st. Floor, Tupolevlaan 48, 1119NZ, Schiphol-Rijk, The Netherlands  
 Tel: 31-20-654-1420 Fax: 31-20-654-1429 E-Mail: europartner@lsis.com
- **LSIS Japan Co., Ltd., Tokyo, Japan**  
 Tokyo Club Building 13F, 2-6, Kasumigaseki 3-chome, Chiyoda-ku, Tokyo, 100-0013  
 Tel: 81-3-6268-8241 Fax: 81-3-6268-8240 E-Mail: jschuna@lsis.com
- **LSIS USA Inc., Chicago, U.S.A.**  
 980 Woodlands Pkwy, Vernon Hills, IL 60061 USA  
 Tel: 1-800-891-2941 or 1-224-352-2265 Fax: 1-847-383-6543 E-Mail: sales.us@lsis.com

## Overseas Branches

- **LSIS Shanghai Office, China**  
 32nd Floor, International Corporate City, No.3000 NorthZhongshan Road, Putuo District, Shanghai, China, 200063  
 Tel: 86-21-5237-9977(609) Fax: 86-21-5237-7189 E-Mail: ygeo@lsis.com
- **LSIS Beijing Office, China**  
 Room 2306, Building B Landgent Center, No.24 Middle Road, East 3rd Ring Road, Chaoyang District, Beijing, P.R. China  
 Tel: 86-10-5761-3127 Fax: 86-10-5761-3128 E-Mail: sson@lsis.com

- **LSIS Guangzhou Office, China**  
 Room 1818-1820, Xinyuan Building, NO.898 Tianhe North Road, Tianhe District, Guangzhou, P.R. China  
 Tel: 86-20-8326-6784 Fax: 86-20-8326-6287 E-Mail: sojhtroh@lsis.com
- **LSIS Qingdao Office, China**  
 Room 2001, Galaxy Building, 29 ShanDong Road, ShiNan District, QingDao, ShanDong, P.R. China  
 Tel: 86-532-8501-6058 Fax: 86-532-8501-6057 E-Mail: sson@lsis.com
- **LSIS Chengdu Office, China**  
 Room1710, 17/F Huamin Empire Plaza, NO.1 Fuxin Road, Chengdu, P.R. China  
 Tel: 86-28-8670-3200 Fax: 86-28-8670-3203 E-Mail: yangcf@lsis.com
- **LSIS ShenYang Office, China**  
 Room 803, Hongyuan Building, 52 South Nanjing Road, Heping District, Shenyang, P.R. China  
 Tel: 86-24-2321-9050 Fax: 86-24-8386-7210 E-Mail: yangcf@lsis.com
- **LSIS Jinan Office, China**  
 Room 317, Chuangzhan Center, No. 201, Shanda Road, Lixia District, Jinan, Shandong, P.R. China  
 Tel: 86-531-8699-7826 Fax: 86-531-8697-7628 E-Mail: yangcf@lsis.com
- **LSIS Co., Ltd. Tokyo Office, Japan**  
 Tokyo Club Building 13F, 2-6, Kasumigaseki 3-chome, Chiyoda-ku, Tokyo, 100-0013  
 Tel: 81-3-6268-8241 Fax: 81-3-6268-8240
- **LSIS Co., Ltd. Rep. Office, Vietnam**  
 Gema Dept Tower 18F, 6 Le Thanh Ton, District 1, HCM, Vietnam  
 Tel: 84-8-3823-7890 E-Mail: sjbaik@lsis.com
- **LSIS Moscow Office, Russia**  
 123610, Moscow, Street. Barclay 6, Building 5, Office no.322, Russia  
 Tel: 7-499-682-6130 E-Mail: info@lsis-ru.com
- **LSIS Jakarta Office, Indonesia**  
 APL TOWER lantai 10 unit 3, Jl. Letjen S. Parman kav. 28, 11470, Jakarta Barat, Indonesia  
 Tel: 62-21-293-7614 E-Mail: dioh@lsis.com



#### Safety Instructions

- For your safety, please read user's manual thoroughly before operating.
- Contact the nearest authorized service facility for examination, repair, or adjustment.
- Please contact qualified service technician when you need maintenance. Do not disassemble or repair by yourself!
- Any maintenance and inspection shall be performed by the personnel having expertise concerned.



[www.lsis.com](http://www.lsis.com)

#### ■ Head Quarter!

LS-ro 127(Hogye-dong) Dongan-gu, Anyang-si, Gyeonggi-Do, 14119, Korea  
Tel: (82-2)2034-4870/Fax : 82-2-2034-4648 E-mail : cshwang@lsis.com

**Southeast Asia** +82-2-2034-4888 cshwang@lsis.com (Charles Hwang)

**Europe** +82-2-2034-4676 sukyong@lsis.com (Brian Choi)

**Turkey/Israel/CIS** +82-2-2034-4879 dkimc@lsis.com (Daniel Kim)

**Oceania** +82-2-2034-4394 kacho@lsis.com (Kendra Cho)

**North/Latin America** +82-2-2034-4286 hkchung@lsis.com (Hank Raul Chung)

**Southwest Asia/Africa** +82-2-2034-4467 myleed@lsis.com (Henry Lee)

**Middle East** +971-4-886-5360 khchoi1@lsis.com (Lambert Choi)

#### ■ Overseas Subsidiaries

##### •LSIS(Dalian) Co., Ltd. (Dalian, Chin)

Tel: 86-411-8730-7510 Fax: 86-411-8730-7560 E-Mail: jiheo@lsis.com

##### •LSIS(Wuxi) Co., Ltd. (Wuxi, China)

Tel: 86-510-8534-6666-8005 Fax: 86-510-8534-4078 E-Mail: sunhwank@lsis.com

##### •LS VINA Industrial Systems Co., Ltd. (Hanoi, Vietnam)

Tel: 84-4-6275-8055 Fax: 84-4-3882-0220 E-Mail: hjchoid@lsis.com

##### •LSIS Middle East FZE (Dubai, U.A.E.)

Tel: 971-4-886-5360 Fax: 971-4-886-5361 E-Mail: jungyongl@lsis.com

##### •LSIS Europe B.V. (Amsterdam, Netherlands)

Tel: 31-20-654-1420 Fax: 31-20-654-1429 E-Mail: europartner@lsis.com

##### •LSIS Japan Co., Ltd. (Tokyo, Japan)

Tel: 81-3-6268-8241 Fax: 81-3-6268-8240 E-Mail: jschuna@lsis.com

##### •LSIS USA Inc. (Chicago, U.S.A.)

Tel: 1-800-891-2941 Fax: 847-383-6543 E-Mail: sales.us@lsis.com

#### ■ Overseas Branches

##### •LSIS Shanghai Office (China)

Tel: 86-21-5237-9977(609) Fax: 86-21-5237-7189 E-Mail: ygeo@lsis.com

##### •LSIS Beijing Office (China)

Tel: 86-10-5761-3127 Fax: 86-10-5761-3128 E-Mail: sson@lsis.com

##### •LSIS Guangzhou Office (China)

Tel: 86-20-8326-6784 Fax: 86-20-8326-6287 E-Mail: sojhtroh@lsis.com

##### •LSIS Qingdao Office (China)

Tel: 86-532-8501-6058 Fax: 86-532-8501-6057 E-Mail: sson@lsis.com

##### •LSIS Chengdu Office (China)

Tel: 86-28-8670-3200 Fax: 86-28-8670-3203 E-Mail: yangcf@lsis.com

##### •LSIS ShenYang Office (China)

Tel: 86-24-2321-9050 Fax: 86-24-8386-7210 E-Mail: yangcf@lsis.com

##### •LSIS Jinan Office (China)

Tel: 86-531-8699-7826 Fax: 86-531-8697-7628 E-Mail: yangcf@lsis.com

##### •LSIS Co., Ltd. Tokyo Office (Japan)

Tel: 81-3-6268-8241 Fax: 81-3-6268-8240 E-Mail: jschuna@lsis.com

##### •LSIS Co., Ltd. Rep. Office (Vietnam)

Tel: 84-8-3823-7890 E-Mail: sjbaik@lsis.com

##### •LSIS Moscow Office (Russia)

Tel: 84-8-3823-7890 E-Mail: sjbaik@lsis.com

##### •LSIS Jakarta Office (Indonesia)

Tel: 62-21-293-7614 E-Mail: dioh@lsis.com